

# TABLE OF CONTENTS

<b>1.0</b>	<b>INTRODUCTION</b>	<b>1</b>
1.1	SYSTEM COVERAGE	1
1.2	SIX-STEP TROUBLESHOOTING PROCEDURE	1
<b>2.0</b>	<b>IDENTIFICATION OF SYSTEM</b>	<b>1</b>
<b>3.0</b>	<b>SYSTEM DESCRIPTION AND FUNCTIONAL OPERATION</b>	<b>1</b>
3.1	GENERAL DESCRIPTION	1
3.2	FUNCTIONAL OPERATION	1
3.2.1	ECM ON-BOARD DIAGNOSTICS	1
3.2.2	ECM OPERATING MODES	2
3.2.3	MONITORED CIRCUITS	2
3.2.4	SKIS OVERVIEW	2
3.2.5	SKIS ON-BOARD DIAGNOSTICS	2
3.2.6	SKIS OPERATION	2
3.3	DIAGNOSTIC TROUBLE CODES	3
3.3.1	HARD CODE	3
3.3.2	INTERMITTENT CODE	3
3.3.3	ECM DIAGNOSTIC TROUBLE CODES	3
3.3.4	SKIM DIAGNOSTIC TROUBLE CODES	6
3.3.5	HANDLING NO TROUBLE CODE PROBLEMS	7
3.4	USING THE DRBIII®	7
3.4.1	DRBIII® DOES NOT POWER UP	7
3.4.2	DISPLAY IS NOT VISIBLE	7
<b>4.0</b>	<b>DISCLAIMERS, SAFETY, WARNINGS</b>	<b>7</b>
4.1	DISCLAIMERS	7
4.2	SAFETY	7
4.2.1	TECHNICIAN SAFETY INFORMATION	7
4.2.2	VEHICLE PREPARATION FOR TESTING	8
4.2.3	SERVICING SUB-ASSEMBLIES	8
4.2.4	DRBIII® SAFETY INFORMATION	8
4.3	WARNINGS AND CAUTIONS	8
4.3.1	ROAD TEST WARNINGS	8
4.3.2	VEHICLE DAMAGE CAUTIONS	8
<b>5.0</b>	<b>REQUIRED TOOLS AND EQUIPMENT</b>	<b>8</b>
<b>6.0</b>	<b>GLOSSARY OF TERMS</b>	<b>9</b>
<b>7.0</b>	<b>DIAGNOSTIC INFORMATION AND PROCEDURES</b>	<b>11</b>
	<b>COMMUNICATION</b>	
	*NO RESPONSE FROM ECM (PCI BUS) - DIESEL ONLY	12
	*NO RESPONSE FROM ECM (SCI ONLY) - DIESEL ONLY	13
	*PCI BUS COMMUNICATION FAILURE	15
	<b>DRIVEABILITY - DIESEL</b>	
	P0070-AMBIENT AIR TEMPERATURE CIRCUIT SIGNAL VOLTAGE TOO HIGH	18
	P0070-AMBIENT AIR TEMPERATURE CIRCUIT SIGNAL VOLTAGE TOO LOW	18
	P0100-MASS AIR FLOW SENSOR SIGNAL VOLTAGE TOO HIGH	20

## TABLE OF CONTENTS - Continued

P0100-MASS AIR FLOW SENSOR SIGNAL VOLTAGE TOO LOW	.20
P0100-MASS AIR FLOW SENSOR SUPPLY VOLTAGE TOO HIGH OR LOW	.20
P0105-BAROMETRIC PRESSURE CIRCUIT SIGNAL VOLTAGE TOO HIGH	.26
P0105-BAROMETRIC PRESSURE CIRCUIT SIGNAL VOLTAGE TOO LOW	.26
P0606-ECM ERROR GATE ARRAY - COMMUNICATION	.26
P0606-ECM ERROR GATE ARRAY - COMMUNICATION NOT VERIFIED	.26
P0606-ECM ERROR GATE ARRAY - QUANTITY STOP	.26
P0606-ECM ERROR RECOVERY HAS OCCURRED	.26
P0606-ECM ERROR REDUNDANT OVERRUN MONITORING	.26
P1206-CALCULATED INJECTOR VOLTAGE TOO HIGH	.26
P1206-CALCULATED INJECTOR VOLTAGE TOO LOW	.26
P1601-CAPACITOR VOLTAGE 1 VOLTAGE TOO HIGH	.26
P1601-CAPACITOR VOLTAGE 1 VOLTAGE TOO LOW	.26
P1606-AFTER RUN SHUT OFF ERROR-INJECTION POWERSTAGE	.26
P1606-AFTER RUN SHUT OFF ERROR-ZERO QUANTITY	.26
P1608-A/D CONVERTER ERROR APP SENSOR GROUND FAILURE	.26
P1608-A/D CONVERTER ERROR INTERNAL FAILURE	.26
P1608-A/D CONVERTER ERROR VOLTAGE FAILURE	.26
P1610-VOLTAGE REGULATOR SIGNAL VOLTAGE TOO HIGH	.26
P1610-VOLTAGE REGULATOR SIGNAL VOLTAGE TOO LOW	.26
P1680-EEPROM PLAUSIBILITY CHECKSUM ERROR	.26
P1680-EEPROM PLAUSIBILITY CODE WORD INCORRECT OR MISSING	.26
P1680-EEPROM PLAUSIBILITY COMMUNICATION ERROR	.26
P1680-EEPROM PLAUSIBILITY VARIATION NUMBER ERROR	.26
P1680-EEPROM PLAUSIBILITY VIN CHECKSUM ERROR	.26
P1680-EEPROM PLAUSIBILITY WRITE ERROR	.26
P1685-SKIM SYSTEM INVALID SECRET KEY IN EEPROM	.26
P1685-SKIM SYSTEM WRITE ACCESS TO EEPROM FAILURE	.26
P0110-INTAKE AIR TEMP SENSOR CIRCUIT SIGNAL VOLTAGE TOO HIGH	.30
P0110-INTAKE AIR TEMP SENSOR CIRCUIT SIGNAL VOLTAGE TOO LOW	.33
P0115-ENGINE COOLANT TEMP SENSOR CIRCUIT SIGNAL VOLTAGE TOO HIGH	.35
P0115-ENGINE COOLANT TEMP SENSOR CIRCUIT SIGNAL VOLTAGE TOO LOW	.38
P0190-FUEL PRESS SENSOR CIRCUIT MALF SIGNAL VOLTAGE TOO HIGH	.40
P0190-FUEL PRESS SENSOR CIRCUIT MALF SIGNAL VOLTAGE TOO LOW	.44
P0190-FUEL PRESS SENSOR CIRCUIT MALF SUPPLY VOLTAGE TOO HIGH OR LOW	.46
P0201-CYLINDER 1-INJECTOR CIRCUIT CURRENT DECREASE	.47
P0201-CYLINDER 1-INJECTOR CIRCUIT LOAD DROP	.47
P0201-CYLINDER 1-INJECTOR CIRCUIT OVERCURRENT HIGH SIDE	.47
P0201-CYLINDER 1-INJECTOR CIRCUIT OVERCURRENT LOW SIDE	.47
P0202-CYLINDER 2-INJECTOR CIRCUIT CURRENT DECREASE	.47
P0202-CYLINDER 2-INJECTOR CIRCUIT LOAD DROP	.47
P0202-CYLINDER 2-INJECTOR CIRCUIT OVERCURRENT HIGH SIDE	.47
P0202-CYLINDER 2-INJECTOR CIRCUIT OVERCURRENT LOW SIDE	.47
P0203-CYLINDER 3-INJECTOR CIRCUIT CURRENT DECREASE	.47
P0203-CYLINDER 3-INJECTOR CIRCUIT LOAD DROP	.47
P0203-CYLINDER 3-INJECTOR CIRCUIT OVERCURRENT HIGH SIDE	.47
P0203-CYLINDER 3-INJECTOR CIRCUIT OVERCURRENT LOW SIDE	.47
P0204-CYLINDER 4-INJECTOR CIRCUIT CURRENT DECREASE	.47
P0204-CYLINDER 4-INJECTOR CIRCUIT LOAD DROP	.47
P0204-CYLINDER 4-INJECTOR CIRCUIT OVERCURRENT HIGH SIDE	.47

## TABLE OF CONTENTS - Continued

P0204-CYLINDER 4-INJECTOR CIRCUIT OVERCURRENT LOW SIDE .....	47
P0205-CYLINDER 5-INJECTOR CIRCUIT CURRENT DECREASE .....	47
P0205-CYLINDER 5-INJECTOR CIRCUIT LOAD DROP .....	47
P0205-CYLINDER 5-INJECTOR CIRCUIT OVERCURRENT HIGH SIDE .....	47
P0205-CYLINDER 5-INJECTOR CIRCUIT OVERCURRENT LOW SIDE .....	47
P0235-BOOST PRESSURE SENSOR PLAUSIBILITY .....	53
P0235-BOOST PRESSURE SENSOR SIGNAL VOLTAGE TOO HIGH .....	55
P0235-BOOST PRESSURE SENSOR SIGNAL VOLTAGE TOO LOW .....	58
P0235-BOOST PRESSURE SENSOR SUPPLY VOLTAGE TOO HIGH OR LOW ...	61
P0243-TURBOCHARGER WASTEGATE SOLENOID CIRCUIT OPEN CIRCUIT .....	64
P0243-TURBOCHARGER WASTEGATE SOLENOID CIRCUIT SHORT CIRCUIT ..	67
P0335-CKP SENSOR CIRCUIT DYNAMIC PLAUSIBILITY .....	69
P0340-CMP/CKP POSITION SENSOR CIRCUIT - CKP DYNAMIC PLAUSIBILITY ..	71
P0340-CMP/CKP POSITION SENSOR CIRCUIT - CMP/CKP SYNC FAILURE .....	74
P0340-CMP/CKP POSITION SENSOR CIRCUIT - SIGNAL FREQUENCY TOO HIGH .....	77
P0340-CMP/CKP POSITION SENSOR CIRCUIT - STATIC PLAUSIBILITY .....	77
P0380-GLOW PLUG 1 CONTROL CIRCUIT - OPEN CIRCUIT .....	81
P0380-GLOW PLUG 1 CONTROL CIRCUIT - SHORT CIRCUIT .....	81
P0382-GLOW PLUG 2 CONTROL CIRCUIT - OPEN CIRCUIT .....	84
P0382-GLOW PLUG 2 CONTROL CIRCUIT - SHORT CIRCUIT .....	84
P0403-EGR SOLENOID CIRCUIT NEGATIVE DEVIATION .....	87
P0403-EGR SOLENOID CIRCUIT OPEN CIRCUIT .....	89
P0403-EGR SOLENOID CIRCUIT SHORT CIRCUIT .....	91
P0460-FUEL LEVEL SENSOR CIRCUIT SIGNAL VOLTAGE TOO HIGH .....	93
P0460-FUEL LEVEL SENSOR CIRCUIT SIGNAL VOLTAGE TOO LOW .....	96
P0500-VEHICLE SPEED SENSOR FREQUENCY TOO HIGH .....	98
P0500-VEHICLE SPEED SENSOR HIGH LEVEL DURATION .....	98
P0500-VEHICLE SPEED SENSOR PLAUSIBILITY .....	98
P0500-VEHICLE SPEED SENSOR SIGNAL VOLTAGE TOO HIGH .....	98
P0514-BATTERY TEMP SENSOR CIRCUIT SIGNAL VOLTAGE TOO HIGH .....	101
P0514-BATTERY TEMP SENSOR CIRCUIT SIGNAL VOLTAGE TOO LOW .....	103
P0520-OIL PRESS SENSOR CKT MALF SIGNAL VOLTAGE TOO HIGH .....	105
P0520-OIL PRESS SENSOR CKT MALF SIGNAL VOLTAGE TOO LOW .....	108
P0520-OIL PRESS SENSOR CKT MALF SUPPLY VOLTAGE TOO HIGH OR LOW .....	110
P0530-A/C PRESSURE SENSOR CIRCUIT SIGNAL VOLTAGE TOO HIGH .....	112
P0530-A/C PRESSURE SENSOR CIRCUIT SIGNAL VOLTAGE TOO LOW .....	112
P0530-A/C PRESSURE SENSOR CIRCUIT SUPPLY VOLTAGE TOO HIGH OR LOW .....	112
P0560-SYSTEM VOLTAGE TOO HIGH .....	117
P0560-SYSTEM VOLTAGE TOO LOW .....	119
P1536-GENERATOR FIELD CURRENT TOO HIGH .....	119
*CHECKING THE CHARGING SYSTEM OPERATION - DIESEL .....	119
P0579-S/C SWITCH SIGNAL CIRCUIT PLAUSIBILITY .....	123
P0579-S/C SWITCH SIGNAL CIRCUIT SIGNAL VOLTAGE TOO HIGH .....	125
P0579-S/C SWITCH SIGNAL CIRCUIT SIGNAL VOLTAGE TOO LOW .....	127
P0615-STARTER RELAY CIRCUIT SHORT CIRCUIT .....	129
P0620-GENERATOR FIELD CONTROL MALF BATTERY VOLTAGE DEVIATION TOO HIGH .....	131
P0620-GENERATOR FIELD CONTROL MALF BATTERY VOLTAGE DEVIATION TOO LOW .....	131
P0620-GENERATOR FIELD CONTROL MALF BATTERY VOLTAGE TOO HIGH ...	131

## TABLE OF CONTENTS - Continued

P0620-GENERATOR FIELD CONTROL MALF BATTERY VOLTAGE TOO LOW . . .	131
P0620-GENERATOR FIELD CONTROL MALF CHARGING VOLTS TOO LOW . . .	131
P0620-GENERATOR FIELD CONTROL MALF HIGH GENERATOR CURRENT . . .	131
P0620-GENERATOR FIELD CONTROL MALF OPEN CIRCUIT . . . . .	131
P0620-GENERATOR FIELD CONTROL MALF SHORT CIRCUIT . . . . .	131
P0641-SENSOR REFERENCE VOLTAGE A CKT VOLTAGE TOO HIGH . . . . .	135
P0641-SENSOR REFERENCE VOLTAGE A CKT VOLTAGE TOO LOW . . . . .	137
P0645-A/C CLUTCH RELAY CIRCUIT OPEN CIRCUIT . . . . .	140
P0645-A/C CLUTCH RELAY CIRCUIT SHORT CIRCUIT . . . . .	142
P0651-SENSOR REFERENCE VOLTAGE B CKT VOLTAGE TOO HIGH . . . . .	144
P0651-SENSOR REFERENCE VOLTAGE B CKT VOLTAGE TOO LOW . . . . .	146
P0685-ASD RELAY CONTROL CIRCUIT SHUTS OFF TOO EARLY . . . . .	149
P0685-ASD RELAY CONTROL CIRCUIT SHUTS OFF TOO LATE . . . . .	151
P0700-TRANS CONTROL 1-2/4-5 SOLENOID CIRCUIT . . . . .	153
P0700-TRANS CONTROL 2-3 SOLENOID CIRCUIT . . . . .	153
P0700-TRANS CONTROL 3-4 SOLENOID CIRCUIT . . . . .	153
P0700-TRANS CONTROL INTERNAL CONTROLLER . . . . .	153
P0700-TRANS CONTROL MOD. PRESS SOLENOID CIRCUIT . . . . .	153
P0700-TRANS CONTROL SHIFT PRESSURE SOLENOID CIRCUIT . . . . .	153
P0700-TRANS CONTROL SOLENOID SUPPLY VOLTAGE . . . . .	153
P0700-TRANS CONTROL TCC SOLENOID CIRCUIT . . . . .	153
P0702-TRANS CONTROL ABS SENSOR MESSAGE . . . . .	153
P0702-TRANS CONTROL ENGINE T-CASE SWITCH MESSAGE . . . . .	153
P0702-TRANS CONTROL IMPROPER GEAR . . . . .	153
P0702-TRANS CONTROL IMPROPER RATIO OR TRANSMISSION SLIPPING . . .	153
P0702-TRANS CONTROL INTERNAL SHIFTER FAILURE . . . . .	153
P0702-TRANS CONTROL N2 OR N3 INPUT SENSOR CIRCUIT . . . . .	153
P0702-TRANS CONTROL TCC FAULT . . . . .	153
P0703-BRAKE SWITCH SIGNAL CIRCUITS PLAUSIBILITY WITH REDUNDANT CONTACT . . . . .	154
P0703-BRAKE SWITCH SIGNAL CKTS PLAUS W/REDUNDANT CONTACT AFTER INITIALIZATION . . . . .	154
P0836-TRANSFER CASE POSITION SENSOR PLAUSIBILITY . . . . .	158
P0836-TRANSFER CASE POSITION SENSOR PLAUSIBILITY 2 . . . . .	158
P0836-TRANSFER CASE POSITION SENSOR SIGNAL VOLTAGE TOO HIGH . . .	158
P0836-TRANSFER CASE POSITION SENSOR SIGNAL VOLTAGE TOO LOW . . .	158
P0850-P/N SWITCH PLAUSIBILITY . . . . .	161
P1130-FUEL RAIL PRESSURE MALFUNCTION ACTUATOR STICKING . . . . .	163
P1130-FUEL RAIL PRESSURE MALFUNCTION LEAKAGE DETECTED . . . . .	163
P1130-FUEL RAIL PRESSURE MALFUNCTION POSITIVE DEVIATION . . . . .	163
P1130-FUEL RAIL PRESSURE MALFUNCTION PRESSURE TOO HIGH-SHUT OFF . . . . .	163
P1130-FUEL RAIL PRESSURE MALFUNCTION PRESSURE TOO LOW . . . . .	163
P1130-FUEL RAIL PRESSURE MALFUNCTION SOLENOID OPEN . . . . .	163
P1131-FUEL PRESSURE SOLENOID OPEN CIRCUIT . . . . .	167
P1131-FUEL PRESSURE SOLENOID POWERSTAGE ERROR . . . . .	167
P1131-FUEL PRESSURE SOLENOID SHORT CIRCUIT . . . . .	167
P1205-INJECTOR CLASSIFICATION ERROR . . . . .	171
P1205-INJECTOR CLASSIFICATION ERROR CHECKSUM ERROR . . . . .	171
P1235-EXTERNAL FUEL QUANTITY BIT ERROR . . . . .	172
P1235-EXTERNAL FUEL QUANTITY DEMAND ERROR . . . . .	172
P1235-EXTERNAL FUEL QUANTITY PARITY ERROR . . . . .	172
P1235-EXTERNAL FUEL QUANTITY TORQUE ERROR . . . . .	172

## TABLE OF CONTENTS - Continued

P1242-CAN BUS MESSAGE MISSING .....	174
P1242-CAN BUS MESSAGE MISSING FROM TCM .....	174
P1242-CAN BUS MUTE .....	177
P1270-INTAKE PORT SWIRL ACTUATOR SHORT CIRCUIT .....	179
P1270-INTAKE PORT SWIRL ACTUATOR GROUND X. ....	181
P1270-INTAKE PORT SWIRL ACTUATOR OPEN CIRCUIT .....	182
P1499-HYDRAULIC COOLING FAN SOLENOID CIRCUIT OPEN CIRCUIT .....	184
P1499-HYDRAULIC COOLING FAN SOLENOID CIRCUIT SHORT CIRCUIT .....	187
P1511-BATTERY SENSE LINE 1 VOLTAGE TOO HIGH .....	189
P1511-BATTERY SENSE LINE 1 VOLTAGE TOO LOW .....	189
P1512-BATTERY SENSE LINE 2 VOLTAGE TOO HIGH .....	189
P1512-BATTERY SENSE LINE 2 VOLTAGE TOO LOW .....	189
P1605-IGNITION SWITCH PLAUSIBILITY .....	192
P1643-VISCOUS HEATER RELAY OPEN CIRCUIT .....	194
P1643-VISCOUS HEATER RELAY SHORT CIRCUIT .....	194
P1651-MIL/DIAG LAMP VIA J1850 BUS IN FRAME RESPONSE ERROR .....	197
P1651-MIL/DIAG LAMP VIA J1850 BUS STATUS ERROR .....	197
P1652-J1850 COMMUNICATION BUS LOST ARBITRATION .....	199
P1652-J1850 COMMUNICATION BUS RECEIVE TIMEOUT .....	199
P1652-J1850 COMMUNICATION BUS SHORT TO GROUND .....	199
P1652-J1850 COMMUNICATION BUS SHORT TO VOLTAGE .....	199
P1652-J1850 COMMUNICATION BUS SPI ERROR .....	199
P1652-J1850 COMMUNICATION BUS TRANSMIT BUFFER OVERRUN .....	199
P1652-J1850 COMMUNICATION BUS UNAUTHORIZED RESET .....	199
P1685-SKIM SYSTEM INVALID KEY CODE RECEIVED .....	202
P1685-SKIM SYSTEM KEY COMMUNICATION TIMED OUT .....	203
P2120-ACC PEDAL POSITION SENSOR 1 CKT PLAUSIBILITY .....	205
P2120-ACC PEDAL POSITION SENSOR 1 CKT PLAUSIBILITY WITH BRAKE SWITCH .....	205
P2120-ACC PEDAL POSITION SENSOR 1 CKT SIGNAL VOLTAGE TOO HIGH ..	205
P2120-ACC PEDAL POSITION SENSOR 1 CKT SIGNAL VOLTAGE TOO LOW ..	205
P2120-ACC PEDAL POSITION SENSOR 1 CKT SUPPLY VOLTAGE TOO HIGH OR LOW .....	205
P2125-ACC PEDAL POSITION SENSOR 2 CIRCUIT PLAUSIBILITY (WITH SENSOR 1 CIRCUIT) .....	205
P2125-ACC PEDAL POSITION SENSOR 2 CKT SIGNAL VOLTAGE TOO HIGH ..	205
P2125-ACC PEDAL POSITION SENSOR 2 CKT SUPPLY VOLTAGE TOO HIGH OR LOW .....	205
*A/C INOPERATIVE .....	212
*A/C OPERATES IN ALL MODE SWITCH POSITIONS .....	215
*CHECKING THE ACCELERATOR PEDAL POSITION SENSOR CALIBRATION ..	217
*CHECKING THE BOOST PRESSURE SENSOR CALIBRATION .....	218
*CHECKING THE ECM POWER AND GROUND CIRCUITS .....	219
*CHECKING THE EGR SYSTEM .....	220
*CHECKING THE ENGINE COOLANT TEMPERATURE SENSOR CALIBRATION ..	221
*CHECKING THE ENGINE MECHANICAL SYSTEMS .....	222
*CHECKING THE GLOW PLUG OPERATION .....	223
*CHECKING THE PARK NEUTRAL SWITCH SIGNAL .....	225
*CHECKING THE SPEED CONTROL OPERATION .....	227
*CHECKING THE TRANSFER CASE POSITION SENSOR .....	229
*CHECKING THE VISCOUS/CABIN HEATER RELAY .....	230
*CHECKING THE WATER IN FUEL LAMP OPERATION .....	232



## TABLE OF CONTENTS - Continued

*ENGINE CRANKS BUT WILL NOT START .....	234
*ENGINE WILL NOT CRANK .....	238
<b>SENTRY KEY IMMOBILIZER</b>	
ANTENNA FAILURE .....	241
COP FAILURE .....	241
EEPROM FAILURE .....	241
INTERNAL FAULT .....	241
RAM FAILURE .....	241
SERIAL LINK INTERNAL FAULT .....	241
STACK OVERFLOW FAILURE .....	241
PCM STATUS FAILURE .....	243
SERIAL LINK EXTERNAL FAULT .....	243
ROLLING CODE FAILURE .....	245
VIN MISMATCH .....	245
TRANSPONDER COMMUNICATION FAILURE .....	247
TRANSPONDER CYCLIC REDUNDANCY CHECK (CRC) FAILURE .....	247
TRANSPONDER ID MISMATCH .....	247
TRANSPONDER RESPONSE MISMATCH .....	247
<b>VERIFICATION TESTS</b>	
VERIFICATION TESTS .....	250
<b>8.0 COMPONENT LOCATIONS .....</b>	<b>255</b>
<b>8.1 CONTROL MODULES .....</b>	<b>255</b>
<b>8.2 CONTROLS AND SOLENOIDS .....</b>	<b>255</b>
<b>8.3 DATA LINK CONNECTOR .....</b>	<b>256</b>
<b>8.4 FUEL SYSTEM .....</b>	<b>256</b>
<b>8.5 SENSORS .....</b>	<b>256</b>
<b>8.6 SWITCHES .....</b>	<b>258</b>
<b>9.0 CONNECTOR PINOUTS .....</b>	<b>259</b>
A/C COMPRESSOR CLUTCH - BLACK 2 WAY .....	259
A/C PRESSURE TRANSDUCER - BLACK 4 WAY .....	259
ACCELERATOR PEDAL POSITION SENSOR (DIESEL) - BLACK 10 WAY .....	259
BATTERY TEMPERATURE SENSOR - BLACK 2 WAY .....	259
BOOST PRESSURE SENSOR (DIESEL) - BLACK 3 WAY .....	260
BRAKE LAMP SWITCH - GRAY 6 WAY .....	260
CAMSHAFT POSITION SENSOR (DIESEL) - BLACK 3 WAY .....	260
CRANKSHAFT POSITION SENSOR (DIESEL) - BLACK 2 WAY .....	260
DATA LINK CONNECTOR - BLACK 16 WAY .....	261
EGR SOLENOID (DIESEL) - BLACK 2 WAY .....	261
ENGINE CONTROL MODULE C1 (DIESEL) - BLACK 81 WAY .....	262
ENGINE CONTROL MODULE C2 (DIESEL) - BLACK 40 WAY .....	263
ENGINE COOLANT TEMPERATURE SENSOR (DIESEL) - BLACK 2 WAY .....	263
ENGINE OIL PRESSURE SENSOR (DIESEL) - BLACK 3 WAY .....	264
FUEL INJECTOR NO. 1 (DIESEL) - BLACK 2 WAY .....	264
FUEL INJECTOR NO. 2 (DIESEL) - BLACK 2 WAY .....	264
FUEL INJECTOR NO. 3 (DIESEL) - BLACK 2 WAY .....	264
FUEL INJECTOR NO. 4 (DIESEL) - BLACK 2 WAY .....	264
FUEL INJECTOR NO. 5 (DIESEL) - BLACK 2 WAY .....	265
FUEL PRESSURE SENSOR (DIESEL) - BLACK 3 WAY .....	265

## TABLE OF CONTENTS - Continued

FUEL PRESSURE SOLENOID (DIESEL) - BLACK 2 WAY .....	.265
FUEL TANK MODULE (DIESEL) - BLACK 6 WAY .....	.265
GENERATOR (DIESEL) - LT. GRAY 2 WAY .....	.266
INTAKE AIR TEMPERATURE SENSOR (DIESEL) - BLACK 2 WAY .....	.266
INTAKE PORT SWIRL ACTUATOR (DIESEL) - BLACK 3 WAY .....	.266
MASS AIR FLOW SENSOR (DIESEL) - BLACK 5 WAY .....	.266
FUSES (DIESEL) .....	.268
A/C COMPRESSOR CLUTCH RELAY (DIESEL) .....	.268
AUTO SHUT DOWN RELAY (DIESEL) .....	.268
ENGINE STARTER MOTOR RELAY (DIESEL) .....	.269
GLOW PLUG RELAY NO. 1 (DIESEL) .....	.269
GLOW PLUG RELAY NO. 2 (DIESEL) .....	.269
VISCOUS/CABIN HEATER RELAY (DIESEL) .....	.269
SENTRY KEY IMMOBILIZER MODULE - BLACK 6 WAY .....	.270
SPEED CONTROL SWITCH NO. 1 - BLACK 4 WAY .....	.270
SPEED CONTROL SWITCH NO. 2 - BLACK 4 WAY .....	.270
TRANSFER CASE POSITION SENSOR - BLACK 2 WAY .....	.270
TRANSMISSION CONTROL MODULE C1 (DIESEL) - BLACK 18 WAY .....	.271
VISCOUS/CABIN HEATER (DIESEL) - BLACK 2 WAY .....	.271
WASTEGATE SOLENOID (DIESEL) - 2 WAY .....	.271
WATER IN FUEL SENSOR (DIESEL) - BLACK 3 WAY .....	.271
<b>10.0 SCHEMATIC DIAGRAMS .....</b>	<b>.273</b>
<b>10.1 ENGINE CONTROL MODULE .....</b>	<b>.273</b>
<b>11.0 CHARTS AND GRAPHS .....</b>	<b>.275</b>





## 1.0 INTRODUCTION

The procedures contained in this manual include all specifications, instructions and graphics needed to diagnose engine control module (ECM) and sentry key immobilizer system (SKIS) problems; they are no start, diagnostic trouble code (DTC) and no trouble code problems for the ECM. The diagnostics in this manual are based on the trouble condition or symptom being present at the time of diagnosis.

When repairs are required, refer to the appropriate service information for the proper removal and repair procedure.

Diagnostic procedures change every year. New diagnostic systems may be added; carryover systems may be enhanced. **IT IS RECOMMENDED THAT YOU REVIEW THE ENTIRE MANUAL TO BECOME FAMILIAR WITH ALL NEW AND CHANGED DIAGNOSTIC PROCEDURES.**

This manual will cover all the necessary requirements to begin a logical diagnostic path for each problem. If there is a diagnostic trouble code (DTC) detected, go to the trouble code test. If there are no DTCs present, go to a no trouble code (\*), symptom based test.

This book reflects many suggested changes from readers of past issues. After using this book, if you have any comments or recommendations, please fill out the form at the back of the book and mail it back to us.

### 1.1 SYSTEM COVERAGE

This diagnostic procedures manual covers all 2002 WG body vehicles equipped with the 2.7L direct injection diesel engine.

### 1.2 SIX-STEP TROUBLESHOOTING PROCEDURE

Diagnosis of the engine control module (ECM) and sentry key immobilizer system (SKIS) is done in six basic steps:

- verification of complaint
- verification of any related symptom
- symptom analysis
- problem isolation
- repair of isolated problem
- verification of proper operation

**NOTE: All tests in this manual should be performed with the engine at operating temperature, unless specified within a particular test.**

## 2.0 IDENTIFICATION OF SYSTEM

The ECM is located in the left side of the engine compartment attached to the left inner fender behind the battery. The sentry key immobilizer module (SKIM) is located below the steering column behind the steering wheel.

## 3.0 SYSTEM DESCRIPTION AND FUNCTIONAL OPERATION

### 3.1 GENERAL DESCRIPTION

The 2.7L direct injection diesel engine system is equipped with the latest in technical advances. The on-board diagnostics incorporated in the engine control module and SKIM are intended to assist the field technician in repairing vehicle problems by the quickest means.

The engine system incorporates a common rail fuel delivery design. This design utilizes electronically controlled solenoid valve type fuel injectors. Each injector is controlled individually by the ECM. Injector timing and fuel quantity are controlled by the ECM based on inputs from the various sensors. The precision control of the injectors by the ECM helps to reduce the engine noise, odor and smoke.

### 3.2 FUNCTIONAL OPERATION

#### 3.2.1 ECM ON-BOARD DIAGNOSTICS

The ECM has been programmed to monitor many different circuits of the diesel fuel injection system. This monitoring is called on-board diagnostics.

Certain criteria must be met for a trouble code to be entered into the ECM memory. The criteria may be a range of: engine rpm, engine temperature, time or other input signals to the ECM. If all of the criteria for monitoring a system or circuit are met, and a problem is sensed, then a DTC will be stored in the ECM memory.

It is possible that a DTC for a monitored circuit may not be entered into the ECM memory, even though a malfunction has occurred. This may happen when the monitoring criteria has not been met.

The ECM compares input signal voltages from each input device with specifications (the established high and low limits of the input range) that are programmed into it for that device. If the input voltage is not within the specifications and other trouble code criteria are met, a DTC will be stored in the ECM memory.

## GENERAL INFORMATION

---

### 3.2.2 ECM OPERATING MODES

As input signals to the ECM change, the ECM adjusts its response to the output devices. For example, the ECM must calculate a different fuel quantity and fuel timing for engine idle condition than it would for a wide open throttle condition. There are several different modes of operation that determine how the ECM responds to the various input signals.

#### Ignition Switch On (Engine Off)

When the ignition switch is turned on, the ECM activates the glow plug relay for a time period that is determined by engine coolant temperature, atmospheric temperature and battery voltage.

#### Engine Start-up Mode

The ECM uses the engine temperature sensor and the crankshaft position sensor (engine speed) inputs to determine fuel injection quantity.

#### Normal Driving Modes

Engine idle, warm-up, acceleration, deceleration and wide open throttle modes are controlled based on all of the sensor inputs to the ECM. The ECM uses these sensor inputs to adjust fuel quantity and fuel injector timing.

#### Overheat Protection Mode

If the engine temperature is above 105°C (221°F) engine speed above 1000 rpm and vehicle speed is above 30 km/h (19 MPH) the ECM will limit fuel quantity for engine protection.

#### Limp-In Mode

If there is a fault detected with the accelerator pedal position sensor, the ECM will set the engine speed at 1100 RPM.

#### Overspeed Protection Mode

If the ECM detects engine RPM that exceeds 5000 RPM, the ECM will shut off fuel to the injectors until engine RPM falls below 4850. (A DTC does not set for engine overspeed. However, the DRBIII® is able to display the absolute maximum engine RPM, coolant temperature and vehicle speed that the ECM has detected during the life of the ECM).

#### After-Run Mode

The ECM transfers RAM information to ROM and performs an Input/Output state check.

### 3.2.3 MONITORED CIRCUITS

The ECM is able to monitor and identify most driveability related trouble conditions. Some circuits are directly monitored through ECM feedback

circuitry. In addition, the ECM monitors the voltage state of some circuits and compares those states with expected values. Other systems are monitored indirectly when the ECM conducts a rationality test to identify problems.

Although most subsystems of the engine control module are either directly or indirectly monitored, there may be occasions when diagnostic trouble codes are not immediately identified. For a trouble code to set, a specific set of conditions must occur and unless these conditions occur, a DTC will not set.

### 3.2.4 SKIS OVERVIEW

The sentry key immobilizer system (SKIS) is designed to prevent unauthorized vehicle operation. The system consists of a sentry key immobilizer module (SKIM), ignition key(s) equipped with a transponder chip and the ECM. When the ignition switch is turned on, the SKIM interrogates the ignition key. If the ignition key is Valid or Invalid, the SKIM sends a J1850 Bus message to the ECM indicating ignition key status. Upon receiving this message the ECM will terminate engine operation or allow the engine to continue to operate.

### 3.2.5 SKIS ON-BOARD DIAGNOSTICS

The sentry key immobilizer module (SKIM) has been programmed to transmit and monitor many different coded messages as well as J1850 Bus messages. This monitoring is called On-Board Diagnostics. Certain criteria must be met for a DTC to be entered into SKIM memory. The criteria may be a range of; input voltage, J1850 Bus message or coded messages to the SKIM. If all of the criteria for monitoring a circuit or function are met and a fault is detected, a DTC will be stored in the SKIM memory.

### 3.2.6 SKIS OPERATION

When ignition power is supplied to the SKIM, the SKIM performs an internal self-test. After the self-test is complete, the SKIM energizes the antenna (this activates the transponder chip) and sends a challenge to the transponder chip. The transponder chip responds to the challenge by generating an encrypted response message using the following:  
Secret Key - an electronically stored value (identification number) that is unique to each SKIS. The secret key is stored in the SKIM, ECM and all ignition key transponders.  
Challenge - a random number that is generated by the SKIM at each ignition key cycle.

The secret key and challenge are the two variables used in the algorithm that produces the encrypted response message. The transponder uses the crypto algorithm to receive, decode and respond

to the message sent by SKIM. After responding to the coded message, the transponder sends a transponder ID message to the SKIM. The SKIM compares the transponder ID message to the available valid key codes in SKIM memory (8 key maximum at any one time). After validating the ignition key, the SKIM sends a J1850 Bus message called a seed request to the ECM, then waits for the ECM response. If the ECM does not respond, the SKIM will send the seed request again. After twenty failed attempts, the SKIM will stop sending the seed request and store a trouble code in memory. If the ECM sends a seed response, the SKIM sends a valid/invalid key message to the ECM. This is an encrypted message that is generated using the following:

- VIN - Vehicle Identification Number.
- Seed - a random number that is generated by the ECM at each ignition key cycle.

The VIN and seed are two variables used in the rolling code algorithm that encrypts the valid/invalid key message. The ECM uses the rolling code algorithm to receive, decode and respond to the valid/invalid key message sent by the SKIM. After sending the valid/invalid key message, the SKIM waits 3.5 seconds for an ECM status message from the ECM. If the ECM does not respond with a valid key message to the SKIM, a fault is detected and a code is stored.

The SKIS incorporates a warning lamp located in the instrument cluster. The lamp receives switched ignition voltage and is hardwired to the instrument cluster. The SKIS lamp is actuated when the SKIM sends a J1850 Bus message to the instrument cluster requesting the lamp on, off or flashing. The instrument cluster then provides the ground for the lamp.

The SKIM will request lamp operation for the following:

- bulb check at ignition on
- to alert the vehicle operator to a SKIS malfunction
- when the SKIM is in customer key programming mode

For all faults except transponder faults the lamp remains on steady. In the event of a transponder fault the lamp will flash at a rate of 1Hz (once per second). If a fault is present, the lamp will remain on or flashing for the complete ignition cycle. If a fault is stored in SKIM memory which prevents the system from operating properly, the ECM will allow the engine to start and idle for 2 seconds then stall. This may occur up to six times. After the sixth attempt, the ECM prevents the engine from cranking until the fault is corrected.

### 3.3 DIAGNOSTIC TROUBLE CODES

Each diagnostic trouble code (DTC) is diagnosed by following a specific procedure. The diagnostic test procedure contains step-by-step instruction for determining the cause of the DTC as well as no trouble code problems. It is not necessary to perform all of the tests in this book to diagnose an individual code.

Always begin diagnosis by reading the DTCs using the DRBIII®. This will direct you to the specific test(s) that must be performed.

#### 3.3.1 HARD CODE

A DTC that comes back within one cycle of the ignition key is a hard code. This means that the problem is current every time the ECM/SKIM checks that circuit or function. Procedures in this manual verify if the DTC is a hard code at the beginning of each test. When the fault is not a hard code, an intermittent test must be performed. **NOTE:** If the DRBIII® displays faults for multiple components (i.e. ECT, VSS, IAT sensors) identify and check the shared circuits for possible problems before continuing (i.e. sensor grounds or 5-volt supply circuits). Refer to the appropriate schematic to identify shared circuits.

#### 3.3.2 INTERMITTENT CODE

A DTC that is not current every time the ECM/SKIM checks the circuit or function is an intermittent code. Most intermittent DTCs are caused by wiring or connector problems. Problems that come and go like this are the most difficult to diagnose; they must be looked for under specific conditions that cause them. The following checks may assist you in identifying a possible intermittent problem.

- Visually inspect the related wire harness connectors. Look for broken, bent, pushed out, or corroded terminals.
- Visually inspect the related wire harness. Look for chafed, pierced, or partially broken wire.
- Refer to hotlines or technical service bulletins that may apply.

**NOTE:** Electromagnetic (radio) interference can cause an intermittent system malfunction. This interference can interrupt communication between the ignition key transponder and the SKIM.

#### 3.3.3 ECM DIAGNOSTIC TROUBLE CODES

**IMPORTANT NOTE:** Before replacing the ECM for a failed driver, control circuit or ground circuit, be sure to check the related component/circuit integrity for failures not detected due to a double fault in the circuit. Most ECM driver/control circuit failures are caused by internal failures to components

## GENERAL INFORMATION

---

(i.e. relays and solenoids) and shorted circuits (i.e. sensor pull-ups, drivers and ground circuits). These faults are difficult to detect when a double fault has occurred and only one DTC has set.

If the DRBIII® displays faults for multiple components (i.e. VSS, ECT, Batt Temp, etc.), identify and check the shared circuits for possible problems before continuing (i.e. sensor grounds or 5-volt supply circuits). Refer to the appropriate wiring diagrams to identify shared circuits.

A/C CLUTCH RELAY CIRCUIT OPEN CIRCUIT  
A/C CLUTCH RELAY CIRCUIT SHORT CIRCUIT

A/C PRESSURE SENSOR CIRCUIT SIGNAL VOLTAGE TOO HIGH

A/C PRESSURE SENSOR CIRCUIT SIGNAL VOLTAGE TOO LOW

A/C PRESSURE SENSOR CIRCUIT SUPPLY VOLTAGE TOO HIGH OR LOW

ACC PEDAL POSITION SENSOR 1 CKT PLAUSIBILITY WITH BRAKE SWITCH

ACC PEDAL POSITION SENSOR 1 CKT SIGNAL VOLTAGE TOO HIGH

ACC PEDAL POSITION SENSOR 1 CKT SUPPLY VOLTAGE TOO HIGH OR LOW

ACC PEDAL POSITION SENSOR 2 CKT POTENTIOMETER PLAUSIBILITY 1/2

ACC PEDAL POSITION SENSOR 2 CKT SIGNAL VOLTAGE TOO HIGH

ACC PEDAL POSITION SENSOR 2 CKT SUPPLY VOLTAGE TOO HIGH OR LOW

A/D CONVERTER ERROR 5 VOLT SUPPLY FAILURE

A/D CONVERTER ERROR GROUND TO APP FAILURE

A/D CONVERTER ERROR RAM TEST FAILURE

AFTER RUN SHUT OFF ERROR-INJ. POWER-STAGE

AFTER RUN SHUT OFF ERROR-ZERO QUANTITY

AMBIENT AIR TEMPERATURE CIRCUIT SIGNAL VOLTAGE TOO HIGH

AMBIENT AIR TEMPERATURE CIRCUIT SIGNAL VOLTAGE TOO LOW

ASD RELAY CONTROL CIRCUIT SHUTS OFF TOO EARLY

ASD RELAY CONTROL CIRCUIT SHUTS OFF TOO LATE

BAROMETRIC PRESSURE CIRCUIT SIGNAL VOLTAGE TOO HIGH

BAROMETRIC PRESSURE CIRCUIT SIGNAL VOLTAGE TOO LOW

BATTERY SENSE LINE 1 VOLTAGE TOO HIGH

BATTERY SENSE LINE 1 VOLTAGE TOO LOW

BATTERY SENSE LINE 2 VOLTAGE TOO HIGH

BATTERY SENSE LINE 2 VOLTAGE TOO LOW  
BATTERY TEMP SENSOR CIRCUIT SIGNAL VOLTAGE TOO HIGH

BATTERY TEMP SENSOR CIRCUIT SIGNAL VOLTAGE TOO LOW

BOOST PRESSURE SENSOR PLAUSIBILITY  
BOOST PRESSURE SENSOR SIGNAL VOLTAGE TOO HIGH

BOOST PRESSURE SENSOR SIGNAL VOLTAGE TOO LOW

BOOST PRESSURE SENSOR SUPPLY VOLTAGE TOO HIGH OR LOW

BRAKE SWITCH SIGNAL CIRCUITS PLAUSIBILITY AFTER INIT.

BRAKE SWITCH SIGNAL CIRCUITS PLAUSIBILITY WITH REDUNDANT CONTACT

CALCULATED INJECTOR VOLTAGE TOO HIGH

CAN BUS MESSAGE MISSING FROM TCM

CAN BUS MUTE

CAN BUS OPEN

CAPACITOR VOLTAGE 1 VOLTAGE TOO HIGH

CAPACITOR VOLTAGE 1 VOLTAGE TOO LOW

CKP POSITION SENSOR CIRCUIT DYNAMIC PLAUSIBILITY

CMP POSITION SENSOR CIRCUIT CMP/CKP SYNC FAILURE

CMP POSITION SENSOR CIRCUIT DYNAMIC PLAUSIBILITY

CMP POSITION SENSOR CIRCUIT SIGNAL FREQUENCY TOO HIGH

CMP POSITION SENSOR CIRCUIT STATIC PLAUSIBILITY

CYLINDER 1-INJECTOR CIRCUIT CURRENT DECREASE

CYLINDER 1-INJECTOR CIRCUIT LOAD DROP

CYLINDER 1-INJECTOR CIRCUIT OVERCURRENT HIGH SIDE

CYLINDER 1-INJECTOR CIRCUIT OVERCURRENT LOW SIDE

CYLINDER 2-INJECTOR CIRCUIT CURRENT DECREASE

CYLINDER 2-INJECTOR CIRCUIT LOAD DROP

CYLINDER 2-INJECTOR CIRCUIT OVERCURRENT HIGH SIDE

CYLINDER 2-INJECTOR CIRCUIT OVERCURRENT LOW SIDE

CYLINDER 3-INJECTOR CIRCUIT CURRENT DECREASE

CYLINDER 3-INJECTOR CIRCUIT LOAD DROP

CYLINDER 3-INJECTOR CIRCUIT OVERCURRENT HIGH SIDE



## GENERAL INFORMATION

CYLINDER 3-INJECTOR CIRCUIT OVERCURRENT LOW SIDE  
CYLINDER 4-INJECTOR CIRCUIT CURRENT DECREASE  
CYLINDER 4-INJECTOR CIRCUIT LOAD DROP  
CYLINDER 4-INJECTOR CIRCUIT OVERCURRENT HIGH SIDE  
CYLINDER 4-INJECTOR CIRCUIT OVERCURRENT LOW SIDE  
CYLINDER 5-INJECTOR CIRCUIT CURRENT DECREASE  
CYLINDER 5-INJECTOR CIRCUIT LOAD DROP  
CYLINDER 5-INJECTOR CIRCUIT OVERCURRENT HIGH SIDE  
CYLINDER 5-INJECTOR CIRCUIT OVERCURRENT LOW SIDE  
ECM ERROR GATE ARRAY - COMMUNICATION  
ECM ERROR GATE ARRAY - QUANTITY STOP  
ECM ERROR RECOVERY HAS OCCURRED  
ECM ERROR REDUNDANT OVERRUN MONITORING  
EEPROM PLAUSIBILITY CHECKSUM ERROR  
EEPROM PLAUSIBILITY CODE WORD INCORRECT OR MISSING  
EEPROM PLAUSIBILITY COMMUNICATION ERROR  
EEPROM PLAUSIBILITY VARIATION NUMBER ERROR  
EEPROM PLAUSIBILITY VIN CHECKSUM ERROR  
EEPROM PLAUSIBILITY WRITE ERROR  
EGR SOLENOID CIRCUIT NEGATIVE DEVIATION  
EGR SOLENOID CIRCUIT OPEN CIRCUIT  
EGR SOLENOID CIRCUIT SHORT CIRCUIT  
ENGINE COOLANT TEMP SENSOR CIRCUIT SIGNAL VOLTAGE TOO HIGH  
ENGINE COOLANT TEMP SENSOR CIRCUIT SIGNAL VOLTAGE TOO LOW  
EXTERNAL FUEL QUANTITY ACCESS DEMAND NOT PLAUSIBLE  
EXTERNAL FUEL QUANTITY ACCESS PARITY  
EXTERNAL FUEL QUANTITY ACCESS TOGGLE BIT  
EXTERNAL FUEL QUANTITY ACCESS TORQUE  
FUEL LEVEL SENSOR CIRCUIT SIGNAL VOLTAGE TOO HIGH  
FUEL LEVEL SENSOR CIRCUIT SIGNAL VOLTAGE TOO LOW  
FUEL PRESS SENSOR CIRCUIT MALF SIGNAL VOLTAGE TOO HIGH

FUEL PRESS SENSOR CIRCUIT MALF SIGNAL VOLTAGE TOO LOW  
FUEL PRESS SENSOR CIRCUIT MALF SUPPLY VOLTAGE TOO HIGH OR LOW  
FUEL PRESSURE SOLENOID OPEN CIRCUIT  
FUEL PRESSURE SOLENOID POWER STAGE ERROR  
FUEL PRESSURE SOLENOID SHORT CIRCUIT  
FUEL RAIL PRESSURE MALFUNCTION ACTUATOR STICKING  
FUEL RAIL PRESSURE MALFUNCTION LEAKAGE DETECTED  
FUEL RAIL PRESSURE MALFUNCTION POSITIVE DEVIATION AT ENGINE SPEED TOO HIGH  
FUEL RAIL PRESSURE MALFUNCTION PRESSURE TOO HIGH - SHUT OFF  
FUEL RAIL PRESSURE MALFUNCTION PRESSURE TOO LOW  
GENERATOR FIELD CONTROL MALF BATTERY VOLTAGE DEVIATION TOO HIGH  
GENERATOR FIELD CONTROL MALF BATTERY VOLTAGE DEVIATION TOO LOW  
GENERATOR FIELD CONTROL MALF BATTERY VOLTAGE TOO HIGH  
GENERATOR FIELD CONTROL MALF BATTERY VOLTAGE TOO LOW  
GENERATOR FIELD CONTROL MALF HIGH GENERATOR CURRENT  
GENERATOR FIELD CONTROL MALF OPEN CIRCUIT  
GENERATOR FIELD CONTROL MALF SHORT CIRCUIT  
GENERATOR FIELD CURRENT TOO HIGH  
GLOW PLUG 1 CONTROL CIRCUIT OPEN CIRCUIT  
GLOW PLUG 1 CONTROL CIRCUIT SHORT CIRCUIT  
GLOW PLUG 2 CONTROL CIRCUIT OPEN CIRCUIT  
GLOW PLUG 2 CONTROL CIRCUIT SHORT CIRCUIT  
HYDRAULIC COOLING FAN SOLENOID OPEN CIRCUIT  
HYDRAULIC COOLING FAN SOLENOID SHORT CIRCUIT  
IGNITION SWITCH PLAUSIBILITY  
INJECTOR CLASSIFICATION ERROR  
INJECTOR CLASSIFICATION ERROR CHECKSUM ERROR  
INJECTOR CLASSIFICATION ERROR INVALID INJECTOR CLASS  
INTAKE AIR TEMPERATURE SENSOR CIRCUIT SIGNAL VOLTAGE TOO HIGH  
INTAKE AIR TEMPERATURE SENSOR CIRCUIT SIGNAL VOLTAGE TOO LOW  
INTAKE PORT SWIRL ACTUATOR INTERNAL FAULT

## GENERAL INFORMATION

---

INTAKE PORT SWIRL ACTUATOR OPEN CIRCUIT  
INTAKE PORT SWIRL ACTUATOR SHORT CIRCUIT  
J1850 COMMUNICATION BUS LOST ARBITRATION  
J1850 COMMUNICATION BUS RECEIVE TIMEOUT  
J1850 COMMUNICATION BUS SHORT TO GROUND  
J1850 COMMUNICATION BUS SHORT TO VOLTAGE  
J1850 COMMUNICATION BUS SPI ERROR  
J1850 COMMUNICATION BUS TRANSMIT BUFFER OVERRUN  
J1850 COMMUNICATION BUS UNAUTHORIZED RESET  
MASS AIR FLOW SENSOR SIGNAL VOLTAGE TOO HIGH  
MASS AIR FLOW SENSOR SIGNAL VOLTAGE TOO LOW  
MASS AIR FLOW SENSOR SUPPLY VOLTAGE TOO HIGH OR LOW  
MIL/DIAG LAMP VIA J1850 BUS - IN FRAME RESPONSE ERROR  
MIL/DIAG LAMP VIA J1850 BUS - STATUS ERROR  
OIL PRESS SENSOR CKT MALF SIGNAL VOLTAGE TOO HIGH  
OIL PRESS SENSOR CKT MALF SIGNAL VOLTAGE TOO LOW  
OIL PRESS SENSOR CKT MALF SUPPLY VOLTAGE TOO HIGH OR LOW  
P/N SWITCH CIRCUIT RATIONALITY PLAUSIBILITY  
S/C SWITCH SIGNAL CIRCUIT PLAUSIBILITY  
S/C SWITCH SIGNAL CIRCUIT SIGNAL VOLTAGE TOO HIGH  
S/C SWITCH SIGNAL CIRCUIT SIGNAL VOLTAGE TOO LOW  
SENSOR REFERENCE VOLTAGE A CKT VOLTAGE TOO HIGH  
SENSOR REFERENCE VOLTAGE A CKT VOLTAGE TOO LOW  
SENSOR REFERENCE VOLTAGE B CKT VOLTAGE TOO HIGH  
SENSOR REFERENCE VOLTAGE B CKT VOLTAGE TOO LOW  
SKIM SYSTEM INVALID KEY CODE RECEIVED  
SKIM SYSTEM INVALID SECRET KEY IN EEPROM  
SKIM SYSTEM KEY COMMUNICATION TIMED OUT  
SKIM SYSTEM WRITE ACCESS TO EEPROM FAILURE  
STARTER RELAY CIRCUIT SHORT CIRCUIT  
SYSTEM VOLTAGE TOO HIGH

SYSTEM VOLTAGE TOO LOW  
TRANSFER CASE POSITION SENSOR PLAUSIBILITY  
TRANSFER CASE POSITION SENSOR PLAUSIBILITY 2  
TRANSFER CASE POSITION SENSOR SIGNAL VOLTAGE TOO HIGH  
TRANSFER CASE POSITION SENSOR SIGNAL VOLTAGE TOO LOW  
TRANS CONTROL INTERNAL CONTROLLER  
TRANS CONTROL 1-2/4-5 SOLENOID CIRCUIT  
TRANS CONTROL 2-3 SOLENOID CIRCUIT  
TRANS CONTROL 3-4 SOLENOID CIRCUIT  
TRANS CONTROL TCC SOLENOID CIRCUIT  
TRANS CONTROL MOD. PRESS SOLENOID CIRCUIT  
TRANS CONTROL SHIFT PRESSURE SOLENOID CIRCUIT  
TRANS CONTROL SOLENOID SUPPLY VOLTAGE  
TRANS CONTROL N2 OR N3 INPUT SENSOR CIRCUIT  
TRANS CONTROL INTERNAL SHIFT FAILURE  
TRANS CONTROL ABS SENSOR MESSAGE  
TRANS CONTROL IMPROPER RATIO OR TRANSMISSION SLIPPING  
TRANS CONTROL ENGINE T-CASE SWITCH MESSAGE  
TRANS CONTROL TCC FAULT  
TRANS CONTROL IMPROPER GEAR  
TURBOCHARGER WASTEGATE SOL CKT NEGATIVE DEVIATION  
TURBOCHARGER WASTEGATE SOL CKT OPEN CIRCUIT  
TURBOCHARGER WASTEGATE SOL CKT POSITIVE DEVIATION  
TURBOCHARGER WASTEGATE SOL CKT SHORT CIRCUIT  
VEHICLE SPEED SENSOR FREQUENCY TOO HIGH  
VEHICLE SPEED SENSOR PLAUSIBILITY  
VEHICLE SPEED SENSOR SIGNAL VOLTAGE TOO HIGH  
VISCIOUS HEATER OPEN CIRCUIT  
VISCIOUS HEATER SHORT CIRCUIT  
VOLTAGE REGULATOR SIGNAL VOLTAGE TOO HIGH  
VOLTAGE REGULATOR SIGNAL VOLTAGE TOO LOW

### 3.3.4 SKIM DIAGNOSTIC TROUBLE CODES

ANTENNA FAILURE  
COP FAILURE  
EEPROM FAILURE

INTERNAL FAULT  
 PCM STATUS FAILURE  
 RAM FAILURE  
 ROLLING CODE FAILURE  
 SERIAL LINK EXTERNAL FAULT  
 SERIAL LINK INTERNAL FAULT  
 STACK OVERFLOW FAILURE  
 TRANSPONDER COMMUNICATION FAILURE  
 TRANSPONDER CRC (CYCLIC REDUNDANCY CHECK) FAILURE  
 TRANSPONDER ID MISMATCH  
 TRANSPONDER RESPONSE MISMATCH  
 VIN MISMATCH

### 3.3.5 HANDLING NO TROUBLE CODE PROBLEMS

After reading Section 3.0 (System Description and Functional Operation), you should have a better understanding of the theory and operation of the on-board diagnostics and how this relates to the diagnosis of a vehicle that may have a driveability-related symptom or complaint. When there are no trouble codes present, refer to the no trouble code (\*) tests.

### 3.4 USING THE DRBIII®

Refer to the DRBIII® user's guide for instructions and assistance with reading the DTCs, erasing the DTCs, lab scope usage and other DRBIII® functions.

#### 3.4.1 DRBIII® DOES NOT POWER UP

If the LEDs do not light or no sound is emitted at start up, check for loose cable connections or a bad cable. Check the vehicle battery voltage at data link connector cavity 16. A minimum of 11.0 volts is required to adequately power the DRBIII®. Check for proper ground connection at data link connector cavities 4 and 5.

If all connections are proper between the DRBIII® and the vehicle or other devices, and the vehicle battery is fully charged, an inoperative DRBIII® may be the result of a faulty cable or vehicle wiring. For a blank screen, refer to the appropriate diagnostic manual.

#### 3.4.2 DISPLAY IS NOT VISIBLE

Low temperatures will affect the visibility of the display. Adjust the contrast to compensate for this condition.

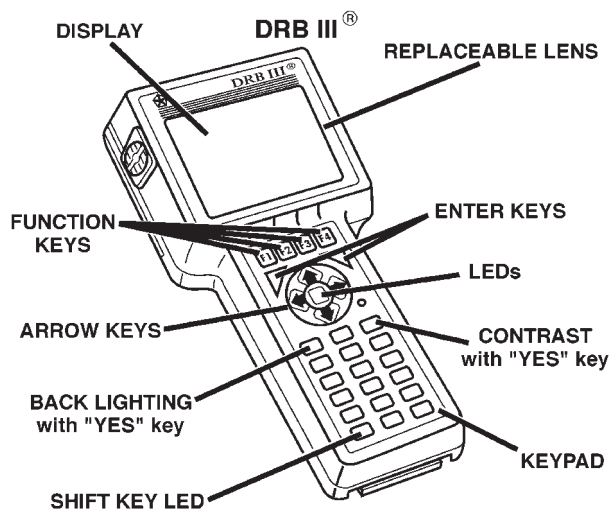

## 4.0 DISCLAIMERS, SAFETY, WARNINGS

### 4.1 DISCLAIMERS

All information, illustrations, and specifications contained in this manual are based on the latest information available at the time of publication. The right is reserved to make changes at any time without notice.

### 4.2 SAFETY

#### 4.2.1 TECHNICIAN SAFETY INFORMATION

**WARNING: ENGINES PRODUCE CARBON MONOXIDE THAT IS ODORLESS, CAUSES SLOWER REACTION TIME, AND CAN LEAD TO SERIOUS INJURY. WHEN THE ENGINE IS OPERATING, KEEP SERVICE AREAS WELL VENTILATED OR ATTACH THE VEHICLE EXHAUST SYSTEM TO THE SHOP EXHAUST REMOVAL SYSTEM.**

Set the parking brake and block the wheels before testing or repairing the vehicle. It is especially important to block the wheels on front wheel drive vehicles; the parking brake does not hold the drive wheels.

When servicing a vehicle, always wear eye protection, and remove any metal jewelry such as watchbands or bracelets that might make electrical contact.

When diagnosing a powertrain system problem, it is important to follow approved procedures where applicable. These procedures can be found in the service manual. Following these procedures is very important to the safety of individuals performing diagnostic tests.



## GENERAL INFORMATION

### 4.2.2 VEHICLE PREPARATION FOR TESTING

Make sure the vehicle being tested has a fully charged battery. If it does not, false diagnostic codes or error messages may occur.

### 4.2.3 SERVICING SUB-ASSEMBLIES

Some components of the powertrain system are intended to be serviced as an assembly only. Attempting to remove or repair certain system sub-components may result in personal injury and/or improper system operation. Only those components with approved repair and installation procedures in the service manual should be serviced.

### 4.2.4 DRBIII® SAFETY INFORMATION

**WARNING: EXCEEDING THE LIMITS OF THE DRBIII® MULTIMETER IS DANGEROUS. IT CAN EXPOSE YOU TO SERIOUS OR POSSIBLY FATAL INJURY. CAREFULLY READ AND UNDERSTAND THE CAUTIONS AND SPECIFICATION LIMITS.**

Follow the vehicle manufacturer's service specifications at all times.

- Do not use the DRBIII® if it has been damaged.
- Do not use the test leads if the insulation is damaged or if metal is exposed.
- To avoid electrical shock, do not touch the test leads, tip or the circuit being tested.
- Choose the proper range and function for the measurement. Do not try voltage or current measurements that may exceed the rated capacity.
- Do not exceed the limits shown in the table below:

FUNCTION	INPUT LIMIT
Volts	0-500 peak volts AC 0-500 volts DC
Ohms (Resistance)*	0-1.12 megohms
Frequency Measure Frequency Generated	0-10 kHz
Temperature	-58 - +1100°F -50 - +600°C

\* Ohms cannot be measured if voltage is present. Ohms can be measured only in a non-powered circuit.

- Voltage between any terminal and ground must not exceed 500v DC or 500v peak AC.
- Use caution when measuring voltage above 25v DC or 25v AC.
- The circuit being tested must be protected by a 10 amp fuse or circuit breaker.

- Use the low current shunt to measure circuits up to 10 amps. Use the high current shunt to measure circuits exceeding 10 amps.
- When testing for the presence of voltage or current, make sure the meter is functioning correctly. Take a reading of a known voltage or current before accepting a zero reading.
- When measuring current, connect the meter in series with the load.
- Disconnect the live test lead before disconnecting the common test lead.

## 4.3 WARNINGS AND CAUTIONS

### 4.3.1 ROAD TEST WARNINGS

Some complaints will require a test drive as part of the repair verification procedure. The purpose of the test drive is to try to duplicate the diagnostic code or symptom condition.

**CAUTION: Before road testing a vehicle, be sure that all components are reassembled. During the test drive, do not hang the DRBIII® from the rear view mirror. Do not attempt to read the DRBIII® while driving. Have an assistant available to operate the DRBIII®.**

### 4.3.2 VEHICLE DAMAGE CAUTIONS

Before disconnecting any control module, make sure the ignition is off. Failure to do so could damage the module. When testing voltage or circuit integrity at any control module, use the terminal side (not the wire end) of the harness connector. Do not probe through the insulation; this will damage it and eventually cause it to fail because of corrosion.

Be careful when performing electrical test so as to prevent accidental shorting of terminals. Such a mistake can damage fuses or components. Also, a second code could be set, making diagnosis of the original problem more difficult.

## 5.0 REQUIRED TOOLS AND EQUIPMENT

DRBIII® (diagnostic read-out box) scan tool  
vacuum gauge  
ammeter  
ohmmeter  
voltmeter  
jumper wires and probes  
oscilloscope

## 6.0 GLOSSARY OF TERMS

<b>A/C</b>	air conditioning	<b>IAT</b>	intake air temperature (sensor)
<b>APP</b>	accelerator pedal position (sensor)	<b>lack of power, sluggish</b>	the engine power output has been reduced
<b>ASD</b>	automatic shut down	<b>MAF</b>	mass air flow (sensor)
<b>backfire, popback</b>	fuel ignites in either the intake or the exhaust system	<b>MIL</b>	malfunction indicator lamp
<b>BCM</b>	body control module	<b>ms</b>	millisecond(s)
<b>BP</b>	boost pressure (sensor)	<b>PDC</b>	power distribution center
<b>CKP</b>	crankshaft position (sensor)	<b>poor fuel economy</b>	there is significantly less fuel mileage than other vehicles of the same design and configuration
<b>CMP</b>	camshaft position (sensor)	<b>runs rough/unstable idle</b>	the engine runs unevenly at idle causing the engine to shake if it is severe enough
<b>cuts out, misses</b>	a steady pulsation or the inability of the engine to maintain a consistent rpm	<b>S/C</b>	speed control
<b>DLC</b>	data link connector	<b>SCI</b>	standard corporate interface
<b>detonation, spark knock</b>	a mild to severe ping, especially under loaded engine conditions	<b>SKIM</b>	sentry key immobilizer module
<b>ECM</b>	engine control module	<b>SKIS</b>	sentry key immobilizer system
<b>ECT</b>	engine coolant temperature (sensor)	<b>start and stall</b>	The engine starts but immediately dies (stalls)
<b>EGR</b>	exhaust gas recirculation (solenoid/valve)	<b>surge</b>	engine rpm fluctuation without corresponding change in accelerator pedal position
<b>hard start</b>	the engine takes longer than usual to start, even though it is able to crank at normal speed.	<b>SRC</b>	signal range check
		<b>WIF</b>	water in fuel (sensor)
		<b>VSS</b>	vehicle speed sensor



---

7.0

DIAGNOSTIC INFORMATION AND  
PROCEDURES

**Symptom:**

**\*NO RESPONSE FROM ECM (PCI BUS) - DIESEL ONLY**

POSSIBLE CAUSES
ECM PCI NO RESPONSE PCI BUS CIRCUIT OPEN ENGINE CONTROL MODULE

TEST	ACTION	APPLICABILITY
1	<p>Turn the ignition on.</p> <p><b>NOTE: As soon as one or more module communicates with the DRB, answer the question.</b></p> <p>With the DRB, enter Body then Body Computer.</p> <p>With the DRB, enter Anti-Lock Brakes.</p> <p>With the DRB, enter Body then Electro/Mechanical Cluster (MIC).</p> <p>With the DRB, enter Passive Restraints then Airbag.</p> <p>Were you able to establish communications with any of the modules?</p> <p style="padding-left: 40px;">Yes → Go To 2</p> <p style="padding-left: 40px;">No → Refer to symptom PCI Bus Communication Failure in the Communications category. Perform ROAD TEST VERIFICATION - VER-2.</p>	All
2	<p>With the DRB read ECM Diagnostic Trouble Codes. This is to ensure power and grounds to the ECM are operational.</p> <p><b>NOTE: If the DRB will not read ECM DTCs, follow the NO RESPONSE TO ECM (SCI only) symptom path, if vehicle will start. For NO START Conditions follow the no start symptom in the powertrain diagnostic information.</b></p> <p>Turn the ignition off.</p> <p>Disconnect the ECM C1 harness connector.</p> <p>Use Scope input cable CH7058, Cable to Probe adapter CH7062, and the red and black test probes.</p> <p>Connect the scope input cable to the channel one connector on the DRB. Attach the red and black leads and the cable to probe adapter to the scope input cable.</p> <p>With the DRBIII® select Pep Module Tools.</p> <p>Select lab scope.</p> <p>Select Live Data.</p> <p>Select 12 volt square wave.</p> <p>Press F2 for Scope.</p> <p>Press F2 and use the down arrow to set voltage range to 20 volts. Set Probe to x10.</p> <p>Press F2 again when complete.</p> <p>Connect the Black lead to ground. Connect the Red lead to the PCI Bus circuit in the ECM connector.</p> <p>Turn the ignition on.</p> <p>Observe the voltage display on the DRB Lab Scope.</p> <p>Does the voltage pulse from 0 to approximately 7.5 volts?</p> <p style="padding-left: 40px;">Yes → Replace and program the Engine Control Module in accordance with the Service Information. Perform ROAD TEST VERIFICATION - VER-2.</p> <p style="padding-left: 40px;">No → Repair the PCI Bus circuit for an open. Perform ROAD TEST VERIFICATION - VER-2.</p>	All

**Symptom:**

**\*NO RESPONSE FROM ECM (SCI ONLY) - DIESEL ONLY**

POSSIBLE CAUSES
CHECK ECM POWERS AND GROUNDS SCI TRANSMIT CIRCUIT SHORTED TO VOLTAGE TRANSMISSION CONTROL MODULE SCI TRANSMIT CIRCUIT SHORTED TO GROUND SCI TRANSMIT CIRCUIT OPEN ENGINE CONTROL MODULE

TEST	ACTION	APPLICABILITY
1	Perform the symptom Checking ECM Power and Ground Circuits in the Driveability category. Did the vehicle pass this test?  Yes → Go To 2  No → Repair as necessary. Perform ROAD TEST VERIFICATION - VER-2.	All
2	Turn the ignition off. Disconnect the ECM harness connectors. Disconnect the DRB from the DLC. Measure the resistance between ground and the SCI Transmit circuit. Is the resistance below 5.0 ohms?  Yes → Go To 3  No → Go To 4	All
3	Turn the ignition off. Disconnect the TCM C1 harness connector. Measure the resistance between ground and the SCI Transmit circuit. Is the resistance below 5.0 ohms?  Yes → Repair the SCI Transmit circuit for a short to ground. Perform ROAD TEST VERIFICATION - VER-2.  No → Replace the Transmission Control Module in accordance with the service information. Perform ROAD TEST VERIFICATION - VER-2.	All
4	Turn the ignition off. Disconnect the DRB from the DLC. Disconnect the ECM harness connectors. Disconnect the TCM C1 harness connector. Turn the ignition on. Measure the voltage of the SCI Transmit circuit at the DLC connector (cav 7). Is the voltage above 1.0 volt?  Yes → Repair the SCI Transmit circuit for a short to voltage. Perform ROAD TEST VERIFICATION - VER-2.  No → Go To 5	All

# COMMUNICATION

---

## **\*NO RESPONSE FROM ECM (SCI ONLY) - DIESEL ONLY — Continued**

<b>TEST</b>	<b>ACTION</b>	<b>APPLICABILITY</b>
5	Turn the ignition off. Disconnect the ECM harness connectors. Disconnect the DRB from the DLC. Measure the resistance of the SCI Transmit circuit between the ECM connector and the DLC. Is the resistance below 5.0 ohms?  Yes → Go To 6  No → Repair the SCI Transmit circuit for an open. Perform ROAD TEST VERIFICATION - VER-2.	All
6	If there are no possible causes remaining, view repair.  Repair Replace and program the Engine Control Module in accordance with the Service Information. Perform ROAD TEST VERIFICATION - VER-2.	All



**Symptom:**

**\*PCI BUS COMMUNICATION FAILURE**

POSSIBLE CAUSES
<p>WITH THE DRB PERFORM A MODULE SCAN</p> <p>OPEN PCI BUS CIRCUIT AT THE DATA LINK CONNECTOR</p> <p>USING THE DRB, PERFORM THE PCI BUS CONTROL MODE</p> <p>DISCONNECT THE MODULE(S) HARNESS CONNECTOR</p> <p>PCI BUS CIRCUIT SHORTED TO VOLTAGE</p> <p>DISCONNECT THE MODULE(S) HARNESS CONNECTOR</p> <p>PCI BUS CIRCUIT SHORTED TO GROUND</p> <p>WIRING HARNESS INTERMITTENT FAILURE</p>

TEST	ACTION	APPLICABILITY
1	<p><b>Note: Determine which modules this vehicle is equipped with before beginning.</b></p> <p>Connect the Diagnostic Junction Port Tester #8339 to the DRB and to the Diagnostic Junction Port.</p> <p>Using the DRB, along with the Diagnostic Junction Port Tester #8339, select Junction Port Tool then PCI Bus Module Scan and follow the instructions on the DRB.</p> <p>Was the DRB able to scan (I/D or communicate) with any modules?</p> <p style="padding-left: 40px;">Yes → Refer to the Communication category for the related symptom(s). (Individual module no responses). Perform BODY VERIFICATION TEST - VER 1.</p> <p style="padding-left: 40px;">No → Go To 2</p>	All
2	<p>Turn the ignition off.</p> <p>Measure the resistance of the PCI Bus circuit between the Data Link Connector and the Diagnostic Junction Port connector.</p> <p>Is the resistance below 5.0 ohms?</p> <p style="padding-left: 40px;">Yes → Go To 3</p> <p style="padding-left: 40px;">No → Repair the PCI Bus circuit for an open between the DLC and the Diagnostic Junction Port. Perform BODY VERIFICATION TEST - VER 1.</p>	All

**\*PCI BUS COMMUNICATION FAILURE — Continued**

TEST	ACTION	APPLICABILITY
3	<p><b>Note: Determine which modules this vehicle is equipped with before beginning.</b>            Connect the Diagnostic Junction Port Tester #8339 to the DRB and to the Diagnostic Junction Port.            Using the DRB, along with the Diagnostic Junction Port Tester #8339, select Junction Port Tool then PCI Bus Control Mode and follow the instructions on the DRB.  <b>Note: Perform this function on each pin that is equipped with a PCI Bus circuit.</b>            Did the DRB display No Modules Responding from any of the pins that were scanned?</p> <p>Yes → Go To 4</p> <p>No → Check the PCI Bus circuit between the DLC and the Diagnostic Junction Port connector for a short to voltage or to ground, repair as necessary.            Perform BODY VERIFICATION TEST - VER 1.</p>	All
4	<p>Disconnect the Diagnostic Junction Port Tester cable from the DRB. Keep the tester connected to the Diagnostic Junction Port.            Turn the ignition on.            Measure the voltage of the PCI Bus circuit on the Diagnostic Junction Port Tester that the DRB displayed No Modules Responding.            Is the voltage steadily above 7.0 volts?</p> <p>Yes → Go To 5</p> <p>No → Go To 6</p>	All
5	<p>Measure the voltage of the PCI Bus circuit on the Diagnostic Junction Port tester that previously measured above 7.0 volts.  <b>Note: Turn the ignition off before disconnecting any module harness connector then turn the ignition on.</b>            Disconnect the module harness connector(s).  <b>NOTE: If the problem occurred on a bus circuit that has more than one module on the same circuit, observe the voltmeter while disconnecting each module connector one at a time.</b>            Is the voltage steadily above 7.0 volts with the module(s) disconnected?</p> <p>Yes → Repair the PCI Bus circuit that measured over 7.0 volts for a short to voltage.            Perform BODY VERIFICATION TEST - VER 1.</p> <p>No → Replace the module that when disconnected the short to voltage was eliminated.            Perform BODY VERIFICATION TEST - VER 1.</p>	All
6	<p>Disconnect the Diagnostic Junction Port Tester cable from the DRB. Keep the tester connected to the Diagnostic Junction Port.            Turn the ignition off.            Disconnect the negative battery cable.            Measure the resistance between ground and the PCI Bus circuit on the Diagnostic Junction Port Tester that the DRB displayed No Modules Responding.            Is the resistance below 100.0 ohms?</p> <p>Yes → Go To 7</p> <p>No → Go To 8</p>	All

**\*PCI BUS COMMUNICATION FAILURE — Continued**

TEST	ACTION	APPLICABILITY
7	<p>Disconnect the negative battery cable.                      Measure the resistance between ground and the PCI Bus circuit at the Diagnostic Junction Port tester that previously measured below 100.0 ohms.                      Disconnect the module harness connector(s).  <b>NOTE: If the problem occurred on a bus circuit that has more than one module on the same circuit, observe the ohmmeter while disconnecting each module connector one at a time.</b>                      Is the resistance below 100.0 ohms with the module(s) disconnected?</p> <p>Yes → Repair the PCI Bus circuit that measured below 100.0 ohms for a short to ground.                      Perform BODY VERIFICATION TEST - VER 1.</p> <p>No → Replace the module that when disconnected the short to ground was eliminated.                      Perform BODY VERIFICATION TEST - VER 1.</p>	All
8	<p>Turn the ignition off.  <b>Note: Visually inspect the related wiring harness. Look for any chafed, pierced, pinched, or partially broken wires.</b>  <b>Note: Visually inspect the related wire harness connectors. Look for broken, bent, pushed out, or corroded terminals.</b>                      Were any problems found?</p> <p>Yes → Repair wiring harness/connectors as necessary.                      Perform BODY VERIFICATION TEST - VER 1.</p> <p>No → Test Complete.</p>	All

**Symptom List:**

**P0070-AMBIENT AIR TEMPERATURE CIRCUIT SIGNAL VOLTAGE TOO HIGH**

**P0070-AMBIENT AIR TEMPERATURE CIRCUIT SIGNAL VOLTAGE TOO LOW**

**Test Note: All symptoms listed above are diagnosed using the same tests. The title for the tests will be P0070-AMBIENT AIR TEMPERATURE CIRCUIT SIGNAL VOLTAGE TOO HIGH.**

**When Monitored and Set Condition:**

**P0070-AMBIENT AIR TEMPERATURE CIRCUIT SIGNAL VOLTAGE TOO HIGH**

When Monitored: With the ignition on.

Set Condition: When the BCM detects high voltage on the Ambient Air Temperature Sensor Signal circuit, a J1850 Bus message is sent to the ECM to set this DTC.

**P0070-AMBIENT AIR TEMPERATURE CIRCUIT SIGNAL VOLTAGE TOO LOW**

When Monitored: With the ignition on.

Set Condition: When the BCM detects low voltage on the Ambient Air Temperature Sensor Signal circuit, a J1850 Bus message is sent to the ECM to set this DTC.

**POSSIBLE CAUSES**

REFER TO COMPASS/MINI TRIP COMPUTER SYMPTOM  
INTERMITTENT CONDITION

TEST	ACTION	APPLICABILITY
1	<p><b>NOTE: The Ambient Air Temperature Sensor is hardwired to the Body Control Module (BCM). The Ambient Air Temperature Circuit DTCs are set in the ECM via the J1850 Bus by the BCM.</b></p> <p>Turn the ignition on. With the DRBIII®, erase the ECM DTCs. Cycle the ignition switch from OFF to ON. Monitor the DRBIII® for ECM DTCs. Does the DRBIII® display this DTC?</p> <p>Yes → Refer to symptom *TEMPERATURE DISPLAY INACCURATE OR INOPERATIVE in the Overhead Console category in the Body Diagnostic Information. Perform ROAD TEST VERIFICATION - VER-2.</p> <p>No → Go To 2</p>	All

## P0070-AMBIENT AIR TEMPERATURE CIRCUIT SIGNAL VOLTAGE TOO HIGH — Continued

TEST	ACTION	APPLICABILITY
2	<p><b>WARNING: WHEN THE ENGINE IS OPERATING, DO NOT STAND IN A DIRECT LINE WITH THE FAN. DO NOT PUT YOUR HANDS NEAR THE PULLEYS, BELTS OR FAN. DO NOT WEAR LOOSE CLOTHING.</b></p> <p><b>NOTE: The conditions that set the DTC are not present at this time. The following list may help in identifying the intermittent condition.</b></p> <p>With the engine running at normal operating temperature, monitor the DRB parameters related to the DTC while wiggling the wiring harness. Look for parameter values to change and/or a DTC to set.</p> <p>Review the DTC When Monitored and Set Conditions. If possible, try to duplicate the conditions under which the DTC was set.</p> <p>Refer to any Technical Service Bulletins (TSB) that may apply.</p> <p>Visually inspect the related wiring harness. Look for any chafed, pierced, pinched, or partially broken wires.</p> <p>Visually inspect the related wiring harness connectors. Look for broken, bent, pushed out, or corroded terminals.</p> <p>Were any of the above conditions present?</p> <p>Yes → Repair as necessary. Perform ROAD TEST VERIFICATION - VER-2.</p> <p>No → Test Complete.</p>	All

**Symptom List:**

**P0100-MASS AIR FLOW SENSOR SIGNAL VOLTAGE TOO HIGH  
P0100-MASS AIR FLOW SENSOR SIGNAL VOLTAGE TOO LOW  
P0100-MASS AIR FLOW SENSOR SUPPLY VOLTAGE TOO HIGH OR  
LOW**

---

**Test Note: All symptoms listed above are diagnosed using the same tests.  
The title for the tests will be P0100-MASS AIR FLOW SENSOR  
SIGNAL VOLTAGE TOO HIGH.**

---

**When Monitored and Set Condition:**

**P0100-MASS AIR FLOW SENSOR SIGNAL VOLTAGE TOO HIGH**

When Monitored: With the ignition on.

Set Condition: The MAF Sensor Signal voltage is above 4.8 volts for at least 3 seconds.

**P0100-MASS AIR FLOW SENSOR SIGNAL VOLTAGE TOO LOW**

When Monitored: With the ignition on.

Set Condition: The Mass Air Flow Sensor Signal voltage is below 1.6 volts for at least 3 seconds.

**P0100-MASS AIR FLOW SENSOR SUPPLY VOLTAGE TOO HIGH OR LOW**

When Monitored: With the ignition on.

Set Condition: The Sensor Reference Voltage A voltage to the MAF is below 4.9 volts or above 5.1 volts for at least 3 seconds.

---

**POSSIBLE CAUSES**

ASD RELAY OUTPUT CIRCUIT OPEN

ECM - 5-VOLT SUPPLY CIRCUIT

MASS AIRFLOW SENSOR

SENSOR GROUND OPEN

INTERMITTENT CONDITION

SENSOR REFERENCE VOLTAGE A CIRCUIT OPEN

MAF SENSOR SIGNAL CIRCUIT OPEN

FUEL PRESSURE SENSOR 5-VOLT SUPPLY CIRCUIT SHORTED TO THE SENSOR GROUND CIRCUIT

SENSOR REFERENCE VOLTAGE A CIRCUIT SHORTED TO THE SENSOR GROUND CIRCUIT

MAF SENSOR SIGNAL CIRCUIT SHORTED TO GROUND

ECM SENSOR GROUND CIRCUIT OPEN

FUEL PRESSURE SENSOR 5-VOLT SUPPLY CIRCUIT SHORTED TO GROUND

## P0100-MASS AIR FLOW SENSOR SIGNAL VOLTAGE TOO HIGH — Continued

### POSSIBLE CAUSES

SENSOR REFERENCE VOLTAGE A CIRCUIT SHORTED TO GROUND  
 MAF SENSOR SIGNAL CIRCUIT SHORTED TO THE SENSOR GROUND CIRCUIT  
 FUEL PRESSURE SENSOR 5-VOLT SUPPLY CIRCUIT SHORTED TO VOLTAGE  
 SENSOR REFERENCE VOLTAGE A CIRCUIT SHORTED TO VOLTAGE  
 MAF SENSOR CIRCUIT SHORTED TO VOLTAGE  
 ECM - MAF SENSOR SIGNAL CIRCUIT

TEST	ACTION	APPLICABILITY
1	<p><b>NOTE: If DTC P0641 or P0651 is present with this DTC, diagnose DTCs P0641 and P0651 before diagnosing this DTC.</b></p> <p><b>NOTE: Inspect the turbocharger inlet tube between the MAF Sensor and the turbocharger for damage, restriction or poor connection. Any of these conditions can cause a MAF Plausibility DTC.</b></p> <p>Turn the ignition on.            With the DRBIII®, erase the ECM DTCs.            Test drive the vehicle.            With the DRBIII®, read the ECM DTCs.            Does the DRB III display a Mass Air Flow Sensor DTC?</p> <p>Yes → Go To 2            No → Go To 18</p>	All
2	<p>Turn the ignition off.            Disconnect the MAF Sensor harness connector.            Turn the ignition on.            Measure the voltage of the Sensor Reference Voltage A circuit in MAF Sensor harness connector.            Is the voltage between 4.7 and 5.3 volts?</p> <p>Yes → Go To 3            No → Go To 11</p>	All
3	<p>Turn the ignition off.            Disconnect the MAF Sensor harness connector.            Disconnect the ECM harness connectors.            Remove the ASD Relay from the PDC.            Connect a jumper wire between cavity 30 and cavity 87 of the ASD Relay connector.            Turn the ignition on.            Measure the voltage of the MAF Sensor Signal circuit.            Is the voltage above 1.0 volt?</p> <p>Yes → Repair the MAF Sensor Signal circuit for a short to voltage.            Perform ROAD TEST VERIFICATION - VER-2.</p> <p>No → Go To 4</p>	All



**P0100-MASS AIR FLOW SENSOR SIGNAL VOLTAGE TOO HIGH —**  
**Continued**

TEST	ACTION	APPLICABILITY
4	Turn the ignition off. Disconnect the MAF Sensor harness connector. Disconnect the ECM harness connectors. Measure the resistance of the MAF Sensor Signal circuit. Is the resistance below 10.0 ohms?  Yes → Go To 5  No → Repair the MAF Sensor Signal circuit for an open Perform ROAD TEST VERIFICATION - VER-2.	All
5	Turn the ignition off. Disconnect the MAF Sensor harness connector. Disconnect the ECM harness connectors. Measure the resistance between ground and the MAF Sensor Signal circuit. Is the resistance below 1000 ohms?  Yes → Repair the MAF Sensor Signal circuit for a short to ground. Perform ROAD TEST VERIFICATION - VER-2.  No → Go To 6	All
6	Turn the ignition off. Disconnect the MAF Sensor harness connector. Disconnect the ECM harness connectors. Measure the resistance between the MAF Sensor Signal circuit and the Sensor Ground circuit at of the MAF Sensor harness connector. Is the resistance below 1000 ohms?  Yes → Repair the MAF Sensor Signal for a short to Sensor Ground . Perform ROAD TEST VERIFICATION - VER-2.  No → Go To 7	All
7	Turn the ignition off. Disconnect the MAF Sensor harness connector. Connect a jumper wire between MAF Sensor Signal circuit and the 5-volt supply circuit at the MAF Sensor harness connector . Turn the ignition on. With the DRBIII, read the MAF VOLTS. Does the DRBIII display between 4.0 and 5.5 volts?  Yes → Go To 8  No → Replace and program the Engine Control Module in accordance with the Service Information. Perform ROAD TEST VERIFICATION - VER-2.	All
8	Turn the ignition off. Disconnect the MAF Sensor harness connector. Disconnect the ECM harness connectors. Measure the resistance of the Sensor Ground circuit between the MAF Sensor and the ECM. Is the resistance below 10.0 ohms?  Yes → Go To 9  No → Repair the Sensor Ground circuit for an open. Perform ROAD TEST VERIFICATION - VER-2.	All

## P0100-MASS AIR FLOW SENSOR SIGNAL VOLTAGE TOO HIGH — Continued

TEST	ACTION	APPLICABILITY
9	Turn the ignition off. Disconnect the MAF Sensor harness connector. Turn the ignition on. Measure the voltage between the 5-volt Supply circuit and the Sensor Ground circuit at the MAF Sensor harness connector. Is the voltage above 4.5 volts?  Yes → Go To 10  No → Replace and program the ECM in accordance with the Service Information. Perform ROAD TEST VERIFICATION - VER-2.	All
10	Turn the ignition off. Disconnect the MAF Sensor harness connector. Turn the ignition on. Using a 12-volt test light connected to ground, probe the ASD Relay Output circuit in the MAF Sensor harness connector Does the test light illuminate brightly?  Yes → Replace the MAF Sensor. Perform ROAD TEST VERIFICATION - VER-2.  No → Repair the ASD Relay Output circuit for an open. Perform ROAD TEST VERIFICATION - VER-2.	All
11	Turn the ignition off. Disconnect the MAF Sensor harness connector. Disconnect the ECM harness connectors. Measure the resistance of the Sensor Reference Voltage A circuit. Is the resistance below 10.0 ohms?  Yes → Go To 12  No → Repair the Sensor Reference Voltage A circuit for an open. Perform ROAD TEST VERIFICATION - VER-2.	All
12	Turn the ignition off. Disconnect the MAF Sensor harness connector. Disconnect the ECM harness connectors. Measure the resistance between the Sensor Reference Voltage A circuit and the Sensor Ground circuit at the MAF Sensor harness connector. Disconnect the Accelerator Pedal Position Sensor harness connector. Measure the resistance between the Sensor Reference Voltage A circuit and both Accelerator Pedal Position Sensor Ground circuits. Is the resistance above 100 kohms for both measurements?  Yes → Go To 13  No → Repair the Sensor Reference Voltage A circuit for a short to the Sensor Ground circuit. Perform ROAD TEST VERIFICATION - VER-2.	All

**P0100-MASS AIR FLOW SENSOR SIGNAL VOLTAGE TOO HIGH —  
Continued**

TEST	ACTION	APPLICABILITY
13	<p>Turn the ignition off.                      Disconnect the MAF Sensor harness connector.                      Disconnect the ECM harness connectors.                      Measure the resistance between ground and the Sensor Reference Voltage A circuit at the MAF harness connector.                      Is the resistance below 1000 ohms?</p> <p style="padding-left: 40px;">Yes → Repair the Sensor Reference Voltage A circuit for a short to ground.                      Perform ROAD TEST VERIFICATION - VER-2.</p> <p style="padding-left: 40px;">No → Go To 14</p>	All
14	<p>Turn the ignition off.                      Disconnect the MAF Sensor harness connector.                      Disconnect the ECM harness connectors.                      Remove the ASD Relay from the PDC.                      Connect a jumper wire between cavity 30 and cavity 87 of the ASD Relay connector.                      Turn the ignition on.                      Measure the voltage of the Sensor Reference Voltage A circuit in the ECM harness connector.                      Is the voltage above 1.0 volt?</p> <p style="padding-left: 40px;">Yes → Repair the Sensor Reference Voltage A circuit for a short to voltage.                      Perform ROAD TEST VERIFICATION - VER-2.</p> <p style="padding-left: 40px;">No → Go To 15</p>	All
15	<p>Turn the ignition off.                      Disconnect the Fuel Pressure Sensor harness connector.                      Disconnect the ECM harness connectors.                      Measure the resistance between the 5-volt Supply circuit and the Sensor Ground circuit at the Fuel Pressure Sensor harness connector.                      Is the resistance above 1000 ohms?</p> <p style="padding-left: 40px;">Yes → Go To 16</p> <p style="padding-left: 40px;">No → Repair the Fuel Pressure Sensor 5-volt Supply circuit for a short to the Sensor Ground circuit.                      Perform ROAD TEST VERIFICATION - VER-2.</p>	All
16	<p>Turn the ignition off.                      Disconnect the Fuel Pressure Sensor harness connector.                      Disconnect the ECM harness connectors.                      Measure the resistance between ground and the 5-volt Supply circuit at the Fuel Pressure Sensor harness connector.                      Is the resistance below 1000 ohms?</p> <p style="padding-left: 40px;">Yes → Repair the Fuel Pressure Sensor 5-volt Supply circuit for a short to ground.                      Perform ROAD TEST VERIFICATION - VER-2.</p> <p style="padding-left: 40px;">No → Go To 17</p>	All

## P0100-MASS AIR FLOW SENSOR SIGNAL VOLTAGE TOO HIGH — Continued

TEST	ACTION	APPLICABILITY
17	<p>Turn the ignition off.            Disconnect the Fuel Pressure Sensor harness connector.            Disconnect the ECM harness connectors.            Remove the ASD Relay from the PDC.            Connect a jumper wire between cavity 30 and cavity 87 of the ASD Relay connector.            Turn the ignition on.            Measure the voltage of the 5-volt Supply circuit in the Fuel Pressure Sensor harness connector.            Is the voltage above 1.0 volt?</p> <p>Yes → Repair the Fuel Pressure Sensor 5-volt Supply circuit for a short to voltage.            Perform ROAD TEST VERIFICATION - VER-2.</p> <p>No → Replace and program the Engine Control Module in accordance with the Service Information.            Perform ROAD TEST VERIFICATION - VER-2.</p>	All
18	<p><b>WARNING: WHEN THE ENGINE IS OPERATING, DO NOT STAND IN A DIRECT LINE WITH THE FAN. DO NOT PUT YOUR HANDS NEAR THE PULLEYS, BELTS OR FAN. DO NOT WEAR LOOSE CLOTHING.</b></p> <p><b>NOTE: The conditions that set the DTC are not present at this time. The following list may help in identifying the intermittent condition.</b></p> <p>With the engine running and at normal operating temperature, monitor the DRB parameters related to the DTC while wiggling the wiring harness. Look for parameter values to change and/or a DTC to set.</p> <p>Review the DTC When Monitored and Set Conditions. If possible, try to duplicate the conditions under which the DTC was set.</p> <p>Refer to any Technical Service Bulletins (TSB) that may apply.</p> <p>Visually inspect the related wiring harness. Look for any chafed, pierced, pinched, or partially broken wires.</p> <p>Visually inspect the related wiring harness connectors. Look for broken, bent, pushed out, or corroded terminals.</p> <p>Were any of the above conditions present?</p> <p>Yes → Repair as necessary.            Perform ROAD TEST VERIFICATION - VER-2.</p> <p>No → Test Complete.</p>	All

**Symptom List:**

**P0105-BAROMETRIC PRESSURE CIRCUIT SIGNAL VOLTAGE TOO HIGH**  
**P0105-BAROMETRIC PRESSURE CIRCUIT SIGNAL VOLTAGE TOO LOW**  
**P0606-ECM ERROR GATE ARRAY - COMMUNICATION**  
**P0606-ECM ERROR GATE ARRAY - COMMUNICATION NOT VERIFIED**  
**P0606-ECM ERROR GATE ARRAY - QUANTITY STOP**  
**P0606-ECM ERROR RECOVERY HAS OCCURRED**  
**P0606-ECM ERROR REDUNDANT OVERRUN MONITORING**  
**P1206-CALCULATED INJECTOR VOLTAGE TOO HIGH**  
**P1206-CALCULATED INJECTOR VOLTAGE TOO LOW**  
**P1601-CAPACITOR VOLTAGE 1 VOLTAGE TOO HIGH**  
**P1601-CAPACITOR VOLTAGE 1 VOLTAGE TOO LOW**  
**P1606-AFTER RUN SHUT OFF ERROR-INJECTION POWERSTAGE**  
**P1606-AFTER RUN SHUT OFF ERROR-ZERO QUANTITY**  
**P1608-A/D CONVERTER ERROR APP SENSOR GROUND FAILURE**  
**P1608-A/D CONVERTER ERROR INTERNAL FAILURE**  
**P1608-A/D CONVERTER ERROR VOLTAGE FAILURE**  
**P1610-VOLTAGE REGULATOR SIGNAL VOLTAGE TOO HIGH**  
**P1610-VOLTAGE REGULATOR SIGNAL VOLTAGE TOO LOW**  
**P1680-EEPROM PLAUSIBILITY CHECKSUM ERROR**  
**P1680-EEPROM PLAUSIBILITY CODE WORD INCORRECT OR MISSING**  
**P1680-EEPROM PLAUSIBILITY COMMUNICATION ERROR**  
**P1680-EEPROM PLAUSIBILITY VARIATION NUMBER ERROR**  
**P1680-EEPROM PLAUSIBILITY VIN CHECKSUM ERROR**  
**P1680-EEPROM PLAUSIBILITY WRITE ERROR**  
**P1685-SKIM SYSTEM INVALID SECRET KEY IN EEPROM**  
**P1685-SKIM SYSTEM WRITE ACCESS TO EEPROM FAILURE**

---

**Test Note: All symptoms listed above are diagnosed using the same tests. The title for the tests will be P0105-BAROMETRIC PRESSURE CIRCUIT SIGNAL VOLTAGE TOO HIGH.**

---

**When Monitored and Set Condition:**

**P0105-BAROMETRIC PRESSURE CIRCUIT SIGNAL VOLTAGE TOO HIGH**

When Monitored: With the ignition on.

Set Condition: The Barometric Pressure Sensor Signal is above 4.86 volts.

---

**P0105-BAROMETRIC PRESSURE CIRCUIT SIGNAL VOLTAGE TOO HIGH — Continued**

---

**P0105-BAROMETRIC PRESSURE CIRCUIT SIGNAL VOLTAGE TOO LOW**

When Monitored: With the ignition on.

Set Condition: The Barometric Pressure Sensor Signal is below 0.22 volts.

**P0606-ECM ERROR GATE ARRAY - COMMUNICATION**

When Monitored: With the ignition on.

Set Condition: The ECM detects an internal failure.

**P0606-ECM ERROR GATE ARRAY - COMMUNICATION NOT VERIFIED**

When Monitored: With the ignition on.

Set Condition: The ECM detects an internal failure.

**P0606-ECM ERROR GATE ARRAY - QUANTITY STOP**

When Monitored: With the ignition on.

Set Condition: The ECM detects an internal failure.

**P0606-ECM ERROR RECOVERY HAS OCCURRED**

When Monitored: With the ignition on.

Set Condition: The ECM detects an internal failure.

**P0606-ECM ERROR REDUNDANT OVERRUN MONITORING**

When Monitored: With the ignition on.

Set Condition: The ECM detects an internal failure.

**P1601-CAPACITOR VOLTAGE 1 VOLTAGE TOO HIGH**

When Monitored: With the engine running. During every 180° of engine rotation.

Set Condition: The ECM determines that the capacitor voltage is greater than 100 volts.

**P1601-CAPACITOR VOLTAGE 1 VOLTAGE TOO LOW**

When Monitored: With the engine running. During every 180° of engine rotation.

Set Condition: The ECM determines that the capacitor voltage is less than 91 volts.

**P1606-AFTER RUN SHUT OFF ERROR-INJECTION POWERSTAGE**

When Monitored: At ignition off.

Set Condition: The ECM detects the engine speed has not fallen below 650 RPM within 0.5 seconds after ignition off.

**P1606-AFTER RUN SHUT OFF ERROR-ZERO QUANTITY**

When Monitored: At ignition off.

Set Condition: The ECM detects the engine speed has not fallen below 650 RPM within 0.5 seconds after ignition off.

**P0105-BAROMETRIC PRESSURE CIRCUIT SIGNAL VOLTAGE TOO HIGH — Continued**

---

**P1680-EEPROM PLAUSIBILITY CHECKSUM ERROR**

When Monitored: With the ignition on.

Set Condition: The ECM detects an internal failure.

**P1680-EEPROM PLAUSIBILITY CODE WORD INCORRECT OR MISSING**

When Monitored: With the ignition on.

Set Condition: The ECM detects the codeword test routine not yet performed (for injector classification).

**P1680-EEPROM PLAUSIBILITY COMMUNICATION ERROR**

When Monitored: With the ignition on.

Set Condition: The ECM detects an internal failure.

**P1680-EEPROM PLAUSIBILITY VARIATION NUMBER ERROR**

When Monitored: With the ignition on.

Set Condition: The ECM detects incorrect software programming.

**P1680-EEPROM PLAUSIBILITY VIN CHECKSUM ERROR**

When Monitored: With the ignition on.

Set Condition: The ECM detects an internal failure.

**P1680-EEPROM PLAUSIBILITY WRITE ERROR**

When Monitored: With the ignition on.

Set Condition: The ECM detects an internal failure.

**P1685-SKIM SYSTEM INVALID SECRET KEY IN EEPROM**

When Monitored: With the ignition on.

Set Condition: The ECM detects an internal mismatch of the secret key code when performing an internal EEPROM check.

**P1685-SKIM SYSTEM WRITE ACCESS TO EEPROM FAILURE**

When Monitored: With the ignition on.

Set Condition: The ECM detects an internal EEPROM fault.

**POSSIBLE CAUSES**

ENGINE CONTROL MODULE  
INTERMITTENT CONDITION



## P0105-BAROMETRIC PRESSURE CIRCUIT SIGNAL VOLTAGE TOO HIGH — Continued

TEST	ACTION	APPLICABILITY
1	<p><b>NOTE: This DTC indicates an internal ECM problem.</b></p> <p>Turn the ignition on.            With the DRBIII®, erase ECM DTCs.            Perform several engine run cycles, turning the ignition off for at least 20 seconds between each engine run cycle.            With the DRBIII®, read the ECM DTCs.            Did this DTC set again?</p> <p>Yes → Replace and program the Engine Control Module in accordance with the Service Information.            Perform ROAD TEST VERIFICATION - VER-2.</p> <p>No → Go To 2</p>	All
2	<p><b>WARNING: WHEN THE ENGINE IS OPERATING, DO NOT STAND IN A DIRECT LINE WITH THE FAN. DO NOT PUT YOUR HANDS NEAR THE PULLEYS, BELTS OR FAN. DO NOT WEAR LOOSE CLOTHING.</b></p> <p><b>NOTE: The conditions that set the DTC are not present at this time. The following list may help in identifying the intermittent condition.</b></p> <p>With the engine running at normal operating temperature, monitor the DRB parameters related to the DTC while wiggling the wiring harness. Look for parameter values to change and/or a DTC to set.            Review the DTC When Monitored and Set Conditions. If possible, try to duplicate the conditions under which the DTC was set.            Refer to any Technical Service Bulletins (TSB) that may apply.            Visually inspect the related wiring harness. Look for any chafed, pierced, pinched, or partially broken wires.            Visually inspect the related wiring harness connectors. Look for broken, bent, pushed out, or corroded terminals.            Were any of the above conditions present?</p> <p>Yes → Repair as necessary.            Perform ROAD TEST VERIFICATION - VER-2.</p> <p>No → Test Complete.</p>	All

**Symptom:**

**P0110-INTAKE AIR TEMP SENSOR CIRCUIT SIGNAL VOLTAGE TOO HIGH**

**When Monitored and Set Condition:**

**P0110-INTAKE AIR TEMP SENSOR CIRCUIT SIGNAL VOLTAGE TOO HIGH**

When Monitored: With the ignition on.

Set Condition: The Intake Air Temperature Sensor Signal voltage is above 4.83 volts.

POSSIBLE CAUSES
INTERMITTENT CONDITION
INTAKE AIR TEMP SENSOR SIGNAL CIRCUIT SHORTED TO VOLTAGE
INTAKE AIR TEMP SENSOR GROUND CIRCUIT OPEN
INTAKE AIR TEMP SENSOR SIGNAL CIRCUIT OPEN
IAT SENSOR
ENGINE CONTROL MODULE

TEST	ACTION	APPLICABILITY
1	Turn the ignition on. With the DRB, erase ECM DTCs. Monitor the DRB for ECM DTCs. Did this DTC set again?  Yes → Go To 2  No → Go To 6	All
2	Turn the ignition off. Disconnect the IAT Sensor harness connector. Disconnect the ECM harness connectors. Remove the ASD Relay from the PDC. Connect a jumper wire between cavity 30 and cavity 87 of the ASD Relay connector. Turn the ignition on. Measure the voltage on the IAT Sensor Signal circuit. Is the voltage below 1.0 volt?  Yes → Go To 3  No → Repair the Intake Air Temperature Sensor Signal circuit for a short to voltage. Perform ROAD TEST VERIFICATION - VER-2.  <b>NOTE: Remove the jumper wire.</b>	All

**P0110-INTAKE AIR TEMP SENSOR CIRCUIT SIGNAL VOLTAGE TOO HIGH — Continued**

TEST	ACTION	APPLICABILITY
3	Turn the ignition off. Disconnect the ECM harness connectors. Disconnect the IAT Sensor harness connector. Measure the resistance of the Intake Air Temperature Sensor Signal circuit. Is the resistance below 5.0 ohms?  Yes → Go To 4  No → Repair the Intake Air Temperature Sensor Signal circuit for an open. Perform ROAD TEST VERIFICATION - VER-2.	All
4	Turn the ignition off. Disconnect the IAT Sensor harness connector. Connect a jumper wire between the IAT Sensor Signal and IAT Sensor Ground circuits in the IAT Sensor harness connector. Turn the ignition on. Monitor the DRB for ECM DTCs. Does the DRB display P0110 INTAKE AIR TEMP. SENSOR CIRCUIT SIGNAL VOLTAGE TOO LOW?  Yes → Replace the Intake Air Temperature Sensor. Perform ROAD TEST VERIFICATION - VER-2.  No → Go To 5	All
5	Turn the ignition off. Disconnect the IAT Sensor harness connector. Disconnect the ECM harness connectors. Measure the resistance of the Sensor Ground circuit between the ECM harness connector and the IAT Sensor harness connector. Is the resistance below 10.0 ohms?  Yes → Replace and program the Engine Control Module in accordance with the Service Information. Perform ROAD TEST VERIFICATION - VER-2.  No → Repair the Intake Air Temperature Sensor Ground circuit for an open. Perform ROAD TEST VERIFICATION - VER-2.	All

**P0110-INTAKE AIR TEMP SENSOR CIRCUIT SIGNAL VOLTAGE TOO HIGH — Continued**

TEST	ACTION	APPLICABILITY
6	<p><b>WARNING: WHEN THE ENGINE IS OPERATING, DO NOT STAND IN A DIRECT LINE WITH THE FAN. DO NOT PUT YOUR HANDS NEAR THE PULLEYS, BELTS OR FAN. DO NOT WEAR LOOSE CLOTHING.</b></p> <p><b>NOTE: The conditions that set the DTC are not present at this time. The following list may help in identifying the intermittent condition.</b></p> <p>With the engine running at normal operating temperature, monitor the DRB parameters related to the DTC while wiggling the wiring harness. Look for parameter values to change and/or a DTC to set.</p> <p>Review the DTC When Monitored and Set Conditions. If possible, try to duplicate the conditions under which the DTC was set.</p> <p>Refer to any Technical Service Bulletins (TSB) that may apply.</p> <p>Visually inspect the related wiring harness. Look for any chafed, pierced, pinched, or partially broken wires.</p> <p>Visually inspect the related wiring harness connectors. Look for broken, bent, pushed out, or corroded terminals.</p> <p>Were any of the above conditions present?</p> <p>Yes → Repair as necessary. Perform ROAD TEST VERIFICATION - VER-2.</p> <p>No → Test Complete.</p>	All

**Symptom:**

**P0110-INTAKE AIR TEMP SENSOR CIRCUIT SIGNAL VOLTAGE TOO LOW**

**When Monitored and Set Condition:**

**P0110-INTAKE AIR TEMP SENSOR CIRCUIT SIGNAL VOLTAGE TOO LOW**

When Monitored: With the ignition on.

Set Condition: The Intake Air Temperature Sensor Signal voltage is below 0.073 volt.

**POSSIBLE CAUSES**

INTERMITTENT CONDITION

IAT SENSOR

INTAKE AIR TEMP SENSOR SIGNAL CIRCUIT SHORTED TO GROUND

INTAKE AIR TEMP SENSOR SIGNAL CIRCUIT SHORTED TO SENSOR GROUND

ENGINE CONTROL MODULE

TEST	ACTION	APPLICABILITY
1	Turn the ignition on. With the DRB, erase ECM DTCs. Monitor the DRB for ECM DTCs. Did this DTC set again?  Yes → Go To 2  No → Go To 6	All
2	Turn the ignition off. Disconnect the IAT Sensor harness connector. Turn the ignition on. Monitor the DRB for ECM DTCs. Does the DRB display P0110 INTAKE AIR TEMP SIGNAL VOLTAGE TOO HIGH?  Yes → Replace the Intake Air Temperature Sensor. Perform ROAD TEST VERIFICATION - VER-2.  No → Go To 3	All
3	Turn the ignition off. Disconnect the ECM harness connectors. Disconnect the IAT Sensor harness connector. Measure the resistance between ground and the Intake Air Temperature Sensor Signal circuit. Is the resistance above 100 kohms?  Yes → Go To 4  No → Repair the Intake Air Temperature Sensor Signal circuit for a short to ground. Perform ROAD TEST VERIFICATION - VER-2.	All

**P0110-INTAKE AIR TEMP SENSOR CIRCUIT SIGNAL VOLTAGE TOO LOW — Continued**

TEST	ACTION	APPLICABILITY
4	Turn the ignition off. Disconnect the ECM harness connectors. Disconnect the IAT Sensor harness connector. Measure the resistance between the Intake Air Temperature Sensor Signal circuit and the Sensor Ground circuit. Is the resistance above 100 kohms?  Yes → Go To 5  No → Repair the Intake Air Temperature Sensor Signal circuit for a short to the Sensor Ground circuit. Perform ROAD TEST VERIFICATION - VER-2.	All
5	If there are no possible causes remaining, view repair.  Repair Replace and program the Engine Control Module in accordance with the Service Information. Perform ROAD TEST VERIFICATION - VER-2.	All
6	<p><b>WARNING: WHEN THE ENGINE IS OPERATING, DO NOT STAND IN A DIRECT LINE WITH THE FAN. DO NOT PUT YOUR HANDS NEAR THE PULLEYS, BELTS OR FAN. DO NOT WEAR LOOSE CLOTHING.</b></p> <p><b>NOTE: The conditions that set the DTC are not present at this time. The following list may help in identifying the intermittent condition.</b></p> With the engine running at normal operating temperature, monitor the DRB parameters related to the DTC while wiggling the wiring harness. Look for parameter values to change and/or a DTC to set. Review the DTC When Monitored and Set Conditions. If possible, try to duplicate the conditions under which the DTC was set. Refer to any Technical Service Bulletins (TSB) that may apply. Visually inspect the related wiring harness. Look for any chafed, pierced, pinched, or partially broken wires. Visually inspect the related wiring harness connectors. Look for broken, bent, pushed out, or corroded terminals. Were any of the above conditions present?  Yes → Repair as necessary. Perform ROAD TEST VERIFICATION - VER-2.  No → Test Complete.	All

**Symptom:**

**P0115-ENGINE COOLANT TEMP SENSOR CIRCUIT SIGNAL VOLTAGE TOO HIGH**

**When Monitored and Set Condition:**

**P0115-ENGINE COOLANT TEMP SENSOR CIRCUIT SIGNAL VOLTAGE TOO HIGH**

When Monitored: With the ignition on.

Set Condition: The Engine Coolant Temperature Sensor Signal voltage is above 4.98 volts for more than 3 seconds.

POSSIBLE CAUSES	
INTERMITTENT CONDITION	
ECM ECT SENSOR SIGNAL CIRCUIT SHORTED TO VOLTAGE	
ECT SENSOR GROUND CIRCUIT OPEN	
ECT SENSOR	
ECT SENSOR SIGNAL CIRCUIT OPEN	
ENGINE CONTROL MODULE	

TEST	ACTION	APPLICABILITY
1	<p><b>NOTE: If multiple DTCs are present, the most likely cause is a 5-Volt Supply or Sensor Ground circuit shorted to voltage or ground. Refer to the Service Information Wiring section for circuits that would affect multiple DTCs.</b></p> <p>Turn the ignition on.                      With the DRB, monitor the Engine Coolant Temperature (ECT) Sensor voltage.                      Is the ECT Sensor voltage above 4.98 volts?</p> <p style="padding-left: 40px;">Yes → Go To 2</p> <p style="padding-left: 40px;">No → Go To 7</p>	All
2	<p>Turn the ignition off.                      Disconnect the ECT Sensor harness connector.                      Turn the ignition on.                      Measure the voltage on the ECT Sensor Signal circuit.                      Is the voltage above 5.5 volts?</p> <p style="padding-left: 40px;">Yes → Repair the ECT Sensor Signal circuit for a short to voltage.                      Perform ROAD TEST VERIFICATION - VER-2.</p> <p style="padding-left: 40px;">No → Go To 3</p>	All



**P0115-ENGINE COOLANT TEMP SENSOR CIRCUIT SIGNAL VOLTAGE TOO HIGH — Continued**

TEST	ACTION	APPLICABILITY
3	Turn the ignition off. Disconnect the ECT Sensor harness connector. Connect a jumper wire between the ECT Sensor harness connector cavities. Turn the ignition on. With the DRB, read the ECT Sensor voltage. Is the voltage below 1.0 volt?  Yes → Replace the ECT Sensor in accordance with the Service Information. Perform ROAD TEST VERIFICATION - VER-2.  No → Go To 4	All
4	Turn the ignition off. Disconnect the ECT Sensor harness connector. Disconnect the ECM harness connectors. Measure the resistance of the ECT Sensor Ground circuit. Is the resistance below 10.0 ohms?  Yes → Go To 5  No → Repair the ECT Sensor Ground circuit for an open. Perform ROAD TEST VERIFICATION - VER-2.	All
5	Turn the ignition off. Disconnect the ECM harness connectors. Disconnect the ECT Sensor harness connector. Measure the resistance of the ECT Sensor Signal circuit. Is the resistance below 10.0 ohms?  Yes → Go To 6  No → Repair the ECT Sensor Signal circuit for an open. Perform ROAD TEST VERIFICATION - VER-2.	All
6	If there are no possible causes remaining, view repair.  Repair Replace and program the Engine Control Module in accordance with the Service Information. Perform ROAD TEST VERIFICATION - VER-2.	All

## P0115-ENGINE COOLANT TEMP SENSOR CIRCUIT SIGNAL VOLTAGE TOO HIGH — Continued

TEST	ACTION	APPLICABILITY
7	<p><b>WARNING: WHEN THE ENGINE IS OPERATING, DO NOT STAND IN A DIRECT LINE WITH THE FAN. DO NOT PUT YOUR HANDS NEAR THE PULLEYS, BELTS OR FAN. DO NOT WEAR LOOSE CLOTHING.</b></p> <p><b>NOTE: The conditions that set the DTC are not present at this time. The following list may help in identifying the intermittent condition.</b></p> <p>With the engine running at normal operating temperature, monitor the DRB parameters related to the DTC while wiggling the wiring harness. Look for parameter values to change and/or a DTC to set.</p> <p>Review the DTC When Monitored and Set Conditions. If possible, try to duplicate the conditions under which the DTC was set.</p> <p>Refer to any Technical Service Bulletins (TSB) that may apply.</p> <p>Visually inspect the related wiring harness. Look for any chafed, pierced, pinched, or partially broken wires.</p> <p>Visually inspect the related wiring harness connectors. Look for broken, bent, pushed out, or corroded terminals.</p> <p>Were any of the above conditions present?</p> <p style="padding-left: 40px;">Yes → Repair as necessary. Perform ROAD TEST VERIFICATION - VER-2.</p> <p style="padding-left: 40px;">No → Test Complete.</p>	All

**Symptom:**

**P0115-ENGINE COOLANT TEMP SENSOR CIRCUIT SIGNAL VOLTAGE TOO LOW**

**When Monitored and Set Condition:**

**P0115-ENGINE COOLANT TEMP SENSOR CIRCUIT SIGNAL VOLTAGE TOO LOW**

When Monitored: With the ignition on.

Set Condition: The Engine Coolant Temperature Sensor Signal voltage is below 0.073 volt for more than 3 seconds.

POSSIBLE CAUSES
INTERMITTENT CONDITION
ECT SENSOR
ECT SENSOR SIGNAL CIRCUIT SHORTED TO GROUND
ECT SENSOR SIGNAL AND GROUND CIRCUITS SHORTED TOGETHER
ENGINE CONTROL MODULE

TEST	ACTION	APPLICABILITY
1	Turn the ignition on. With the DRB, monitor the Engine Coolant Temperature (ECT) Sensor voltage. Is the ECT Sensor voltage below 0.073 volt?  Yes → Go To 2  No → Go To 6	All
2	Turn the ignition off. Disconnect the ECT Sensor harness connector. Turn the ignition on. With the DRB, read the ECT Sensor voltage. Is the voltage above 4.0 volts?  Yes → Replace the ECT Sensor in accordance with the Service Information. Perform ROAD TEST VERIFICATION - VER-2.  No → Go To 3	All
3	Turn the ignition off. Disconnect the ECM harness connectors. Disconnect the ECT Sensor harness connector. Measure the resistance between ground and the ECT Sensor Signal circuit. Is the resistance above 1000 ohms?  Yes → Go To 4  No → Repair the ECT Sensor Signal circuit for a short to ground. Perform ROAD TEST VERIFICATION - VER-2.	All

## P0115-ENGINE COOLANT TEMP SENSOR CIRCUIT SIGNAL VOLTAGE TOO LOW — Continued

TEST	ACTION	APPLICABILITY
4	Turn the ignition off. Disconnect the ECM harness connectors. Disconnect the ECT Sensor harness connector. Measure the resistance between the ECT Sensor Signal circuit and Sensor Ground circuit. Is the resistance above 1000 ohms?  Yes → Go To 5  No → Repair the ECT Sensor Signal and Ground circuits for a short together. Perform ROAD TEST VERIFICATION - VER-2.	All
5	If there are no possible causes remaining, view repair.  Repair Replace and program the Engine Control Module in accordance with the Service Information. Perform ROAD TEST VERIFICATION - VER-2.	All
6	<b>WARNING: WHEN THE ENGINE IS OPERATING, DO NOT STAND IN A DIRECT LINE WITH THE FAN. DO NOT PUT YOUR HANDS NEAR THE PULLEYS, BELTS OR FAN. DO NOT WEAR LOOSE CLOTHING.</b> <b>NOTE: The conditions that set the DTC are not present at this time. The following list may help in identifying the intermittent condition.</b> With the engine running at normal operating temperature, monitor the DRB parameters related to the DTC while wiggling the wiring harness. Look for parameter values to change and/or a DTC to set. Review the DTC When Monitored and Set Conditions. If possible, try to duplicate the conditions under which the DTC was set. Refer to any Technical Service Bulletins (TSB) that may apply. Visually inspect the related wiring harness. Look for any chafed, pierced, pinched, or partially broken wires. Visually inspect the related wiring harness connectors. Look for broken, bent, pushed out, or corroded terminals. Were any of the above conditions present?  Yes → Repair as necessary. Perform ROAD TEST VERIFICATION - VER-2.  No → Test Complete.	All

**Symptom:**

**P0190-FUEL PRESS SENSOR CIRCUIT MALF SIGNAL VOLTAGE TOO HIGH**

**When Monitored and Set Condition:**

**P0190-FUEL PRESS SENSOR CIRCUIT MALF SIGNAL VOLTAGE TOO HIGH**

When Monitored: With the ignition on.

Set Condition: The Fuel Rail Pressure Sensor Signal voltage is above 4.8 volts.

<b>POSSIBLE CAUSES</b>
ECM - FUEL PRESSURE SENSOR SIGNAL CIRCUIT SHORTED TO VOLTAGE
ECM - FUEL PRESSURE SENSOR SIGNAL OPEN
FUEL PRESSURE SENSOR SIGNAL CIRCUIT OPEN
FUEL PRESSURE SENSOR SIGNAL CIRCUIT SHORTED TO VOLTAGE
SENSOR GROUND CIRCUIT OPEN
INTERMITTENT CONDITION
5-VOLT SUPPLY CIRCUIT OPEN
SENSOR GROUND CIRCUIT SHORTED TO VOLTAGE
FUEL PRESSURE SENSOR
ENGINE CONTROL MODULE

<b>TEST</b>	<b>ACTION</b>	<b>APPLICABILITY</b>
1	<p><b>WARNING: THE FUEL INJECTION PUMP SUPPLIES HIGH-PRESSURE FUEL TO EACH INDIVIDUAL INJECTOR THROUGH HIGH-PRESSURE FUEL LINES. FUEL UNDER HIGH PRESSURE CAN PENETRATE SKIN AND CAUSE PERSONAL INJURY. WEAR SAFETY GOGGLES AND ADEQUATE PROTECTIVE CLOTHING.</b></p> <p>Turn the ignition on.                      With the DRB, erase ECM DTCs.                      Cycle the ignition key on and off several times, leaving the key on for at least 10 seconds at a time.                      With the DRB, read ECM DTCs.                      Did this DTC set again?</p> <p style="padding-left: 40px;">Yes → Go To 2</p> <p style="padding-left: 40px;">No → Go To 10</p>	All

**P0190-FUEL PRESS SENSOR CIRCUIT MALF SIGNAL VOLTAGE TOO HIGH — Continued**

TEST	ACTION	APPLICABILITY
2	Turn the ignition off. Disconnect the Fuel Pressure Sensor harness connector. Turn the ignition on. Measure the voltage of the Fuel Pressure Sensor Signal circuit. Select the appropriate voltage reading.  Voltage is above 5.5 volts. Go To 3  Voltage is between 4.7 and 5.4 volts. Go To 4  Voltage is below 4.7 volts. Go To 9	All
3	Turn the ignition off. Disconnect the Fuel Pressure Sensor harness connector. Disconnect the ECM harness connectors. Remove the ASD Relay from the PDC. Connect a jumper wire between cavity 30 and cavity 87 of the ASD Relay connector. Turn the ignition on. Measure the voltage of the Fuel Pressure Sensor Signal circuit. Is the voltage below 1.0 volt?  Yes → Replace and program the Engine Control Module in accordance with the Service Information. Perform ROAD TEST VERIFICATION - VER-2.  No → Repair the Fuel Pressure Sensor Signal circuit for a short to voltage. Perform ROAD TEST VERIFICATION - VER-2.	All
4	Turn the ignition off. Disconnect the Fuel Pressure Sensor harness connector. Disconnect the ECM harness connectors. Measure the resistance of the Sensor Ground circuit. Is the resistance below 5.0 ohms?  Yes → Go To 5  No → Repair the Sensor Ground circuit for an open. Perform ROAD TEST VERIFICATION - VER-2.	All
5	Turn the ignition off. Disconnect the Fuel Pressure Sensor harness connector. Disconnect the ECM harness connectors. Measure the resistance of the 5-Volt Supply circuit. Is the resistance below 5.0 ohms?  Yes → Go To 6  No → Repair the 5-volt Supply circuit for an open. Perform ROAD TEST VERIFICATION - VER-2.	All

**P0190-FUEL PRESS SENSOR CIRCUIT MALF SIGNAL VOLTAGE TOO HIGH — Continued**

TEST	ACTION	APPLICABILITY
6	<p>Turn the ignition off.                      Disconnect the Fuel Pressure Sensor harness connector.                      Disconnect the ECM harness connectors.                      Remove the ASD Relay from the PDC.                      Connect a jumper wire between cavity 30 and cavity 87 of the ASD Relay connector.                      Turn the ignition on.                      Measure the voltage of the Sensor Ground circuit at the Fuel Pressure Sensor and ECM harness connectors.                      Is the voltage above 1.0 volt at either connector?</p> <p style="padding-left: 40px;">Yes → Repair the Sensor Ground circuit for a short to voltage.                      Perform ROAD TEST VERIFICATION - VER-2.</p> <p style="padding-left: 40px;">No → Go To 7</p> <p><b>NOTE: If the Sensor Ground circuit had a short to voltage on it, the ECM will be damaged. Retest the Fuel Pressure Sensor circuit.</b></p>	All
7	<p>Turn the ignition off.                      Disconnect the Fuel Pressure Sensor harness connector.                      Connect a jumper wire between the Fuel Pressure Sensor Signal circuit and the Sensor Ground circuit in the Fuel Pressure Sensor harness connector.                      Turn the ignition on and monitor the DRB for DTCs.                      Is DTC P0190 FUEL PRESS SENSOR CIRCUIT MALF SIGNAL VOLTAGE TOO LOW present?</p> <p style="padding-left: 40px;">Yes → Replace the Fuel Pressure Sensor.                      Perform ROAD TEST VERIFICATION - VER-2.</p> <p style="padding-left: 40px;">No → Go To 8</p>	All
8	<p>If there are no possible causes remaining, view repair.</p> <p style="padding-left: 40px;">Repair</p> <p style="padding-left: 80px;">Replace and program the Engine Control Module in accordance with the Service Information.                      Perform ROAD TEST VERIFICATION - VER-2.</p>	All
9	<p>Turn the ignition off.                      Disconnect the Fuel Pressure Sensor harness connector.                      Disconnect the ECM harness connectors.                      Measure the resistance of the Fuel Pressure Sensor Signal circuit.                      Is the resistance below 5.0 ohms?</p> <p style="padding-left: 40px;">Yes → Replace and program the Engine Control Module in accordance with the Service Information.                      Perform ROAD TEST VERIFICATION - VER-2.</p> <p style="padding-left: 40px;">No → Repair the Fuel Pressure Sensor Signal circuit for an open.                      Perform ROAD TEST VERIFICATION - VER-2.</p>	All



**P0190-FUEL PRESS SENSOR CIRCUIT MALF SIGNAL VOLTAGE TOO HIGH — Continued**

TEST	ACTION	APPLICABILITY
10	<p><b>WARNING: WHEN THE ENGINE IS OPERATING, DO NOT STAND IN A DIRECT LINE WITH THE FAN. DO NOT PUT YOUR HANDS NEAR THE PULLEYS, BELTS OR FAN. DO NOT WEAR LOOSE CLOTHING.</b></p> <p><b>NOTE: The conditions that set the DTC are not present at this time. The following list may help in identifying the intermittent condition.</b></p> <p>With the engine running and at normal operating temperature, monitor the DRB parameters related to the DTC while wiggling the wiring harness. Look for parameter values to change and/or a DTC to set.</p> <p>Review the DTC When Monitored and Set Conditions. If possible, try to duplicate the conditions under which the DTC was set.</p> <p>Refer to any Technical Service Bulletins (TSB) that may apply.</p> <p>Visually inspect the related wiring harness. Look for any chafed, pierced, pinched, or partially broken wires.</p> <p>Visually inspect the related wiring harness connectors. Look for broken, bent, pushed out, or corroded terminals.</p> <p>Were any of the above conditions present?</p> <p style="padding-left: 40px;">Yes → Repair as necessary. Perform ROAD TEST VERIFICATION - VER-2.</p> <p style="padding-left: 40px;">No → Test Complete.</p>	All

**Symptom:**

**P0190-FUEL PRESS SENSOR CIRCUIT MALF SIGNAL VOLTAGE TOO LOW**

**When Monitored and Set Condition:**

**P0190-FUEL PRESS SENSOR CIRCUIT MALF SIGNAL VOLTAGE TOO LOW**

When Monitored: With the ignition on.

Set Condition: The Fuel Rail Pressure Sensor Signal voltage is below 0.2 volt.

POSSIBLE CAUSES
FUEL PRESSURE SENSOR
INTERMITTENT CONDITION
FUEL PRESSURE SENSOR SIGNAL CIRCUIT SHORTED TO GROUND
FUEL PRESSURE SENSOR SIGNAL CIRCUIT SHORTED TO SENSOR GROUND
ECM - FUEL PRESSURE SENSOR SIGNAL SHORTED TO GROUND

TEST	ACTION	APPLICABILITY
1	<p><b>WARNING: THE FUEL INJECTION PUMP SUPPLIES HIGH-PRESSURE FUEL TO EACH INDIVIDUAL INJECTOR THROUGH HIGH-PRESSURE FUEL LINES. FUEL UNDER HIGH PRESSURE CAN PENETRATE SKIN AND CAUSE PERSONAL INJURY. WEAR SAFETY GOGGLES AND ADEQUATE PROTECTIVE CLOTHING.</b></p> <p><b>NOTE: If DTC P0641 or P0651 is present with this DTC, diagnose DTCs P0641 and P0651 before diagnosing this DTC.</b></p> <p>Turn the ignition on.                      With the DRB, erase ECM DTCs.                      Cycle the ignition key on and off several times, leaving the key on for at least 10 seconds at a time.                      With the DRB, read ECM DTCs.                      Did this DTC set again?</p> <p style="padding-left: 40px;">Yes → Go To 2</p> <p style="padding-left: 40px;">No → Go To 6</p>	All
2	<p>Turn the ignition off.                      Disconnect the Fuel Pressure Sensor harness connector.                      Measure the voltage of the Fuel Pressure Sensor Signal circuit.                      Is the voltage between 4.7 and 5.3 volts?</p> <p style="padding-left: 40px;">Yes → Replace the Fuel Pressure Sensor.                      Perform ROAD TEST VERIFICATION - VER-2.</p> <p style="padding-left: 40px;">No → Go To 3</p>	All

## P0190-FUEL PRESS SENSOR CIRCUIT MALF SIGNAL VOLTAGE TOO LOW — Continued

TEST	ACTION	APPLICABILITY
3	Turn the ignition off. Disconnect the Fuel Pressure Sensor harness connector. Disconnect the ECM harness connectors. Measure the resistance between ground and the Fuel Pressure Sensor Signal circuit. Is the resistance above 100 kohms?  Yes → Go To 4  No → Repair the Fuel Pressure Sensor Signal circuit for a short to ground. Perform ROAD TEST VERIFICATION - VER-2.	All
4	Turn the ignition off. Disconnect the Fuel Pressure Sensor harness connector. Disconnect the ECM harness connectors. Measure the resistance between the Sensor Ground circuit and the Fuel Pressure Sensor Signal circuit. Is the resistance above 100 kohms?  Yes → Go To 5  No → Repair the Fuel Pressure Sensor Signal circuit for a short to the Sensor Ground circuit. Perform ROAD TEST VERIFICATION - VER-2.	All
5	If there are no possible causes remaining, view repair.  Repair Replace and program the Engine Control Module in accordance with the Service Information. Perform ROAD TEST VERIFICATION - VER-2.	All
6	<b>WARNING: WHEN THE ENGINE IS OPERATING, DO NOT STAND IN A DIRECT LINE WITH THE FAN. DO NOT PUT YOUR HANDS NEAR THE PULLEYS, BELTS OR FAN. DO NOT WEAR LOOSE CLOTHING.</b> <b>NOTE: The conditions that set the DTC are not present at this time. The following list may help in identifying the intermittent condition.</b> With the engine running and at normal operating temperature, monitor the DRB parameters related to the DTC while wiggling the wiring harness. Look for parameter values to change and/or a DTC to set. Review the DTC When Monitored and Set Conditions. If possible, try to duplicate the conditions under which the DTC was set. Refer to any Technical Service Bulletins (TSB) that may apply. Visually inspect the related wiring harness. Look for any chafed, pierced, pinched, or partially broken wires. Visually inspect the related wiring harness connectors. Look for broken, bent, pushed out, or corroded terminals. Were any of the above conditions present?  Yes → Repair as necessary. Perform ROAD TEST VERIFICATION - VER-2.  No → Test Complete.	All

**Symptom:**

**P0190-FUEL PRESS SENSOR CIRCUIT MALF SUPPLY VOLTAGE TOO HIGH OR LOW**

**When Monitored and Set Condition:**

**P0190-FUEL PRESS SENSOR CIRCUIT MALF SUPPLY VOLTAGE TOO HIGH OR LOW**

When Monitored: With the ignition on.

Set Condition: The Fuel Pressure Sensor 5-Volt Supply voltage is below 4.9 volts or above 5.1 volts for 100 ms.

**POSSIBLE CAUSES**

CHECK FOR SENSOR REFERENCE VOLTAGE A CIRCUIT DTCS  
ENGINE CONTROL MODULE

TEST	ACTION	APPLICABILITY
1	<p><b>WARNING: THE FUEL INJECTION PUMP SUPPLIES HIGH-PRESSURE FUEL TO EACH INDIVIDUAL INJECTOR THROUGH HIGH-PRESSURE FUEL LINES. FUEL UNDER HIGH PRESSURE CAN PENETRATE SKIN AND CAUSE PERSONAL INJURY. WEAR SAFETY GOGGLES AND ADEQUATE PROTECTIVE CLOTHING.</b></p> <p>Turn the ignition on. With the DRB, read ECM DTCs. Is the High or Low DTC for P0641 SENSOR REFERENCE VOLTAGE A CIRCUIT set with this DTC?</p> <p>Yes → Refer to the symptom list for the related symptom(s). Perform ROAD TEST VERIFICATION - VER-2.</p> <p>No → Replace and program the Engine Control Module in accordance with the Service Information. Perform ROAD TEST VERIFICATION - VER-2.</p>	All

**Symptom List:**

**P0201-CYLINDER 1-INJECTOR CIRCUIT CURRENT DECREASE**  
**P0201-CYLINDER 1-INJECTOR CIRCUIT LOAD DROP**  
**P0201-CYLINDER 1-INJECTOR CIRCUIT OVERCURRENT HIGH SIDE**  
**P0201-CYLINDER 1-INJECTOR CIRCUIT OVERCURRENT LOW SIDE**  
**P0202-CYLINDER 2-INJECTOR CIRCUIT CURRENT DECREASE**  
**P0202-CYLINDER 2-INJECTOR CIRCUIT LOAD DROP**  
**P0202-CYLINDER 2-INJECTOR CIRCUIT OVERCURRENT HIGH SIDE**  
**P0202-CYLINDER 2-INJECTOR CIRCUIT OVERCURRENT LOW SIDE**  
**P0203-CYLINDER 3-INJECTOR CIRCUIT CURRENT DECREASE**  
**P0203-CYLINDER 3-INJECTOR CIRCUIT LOAD DROP**  
**P0203-CYLINDER 3-INJECTOR CIRCUIT OVERCURRENT HIGH SIDE**  
**P0203-CYLINDER 3-INJECTOR CIRCUIT OVERCURRENT LOW SIDE**  
**P0204-CYLINDER 4-INJECTOR CIRCUIT CURRENT DECREASE**  
**P0204-CYLINDER 4-INJECTOR CIRCUIT LOAD DROP**  
**P0204-CYLINDER 4-INJECTOR CIRCUIT OVERCURRENT HIGH SIDE**  
**P0204-CYLINDER 4-INJECTOR CIRCUIT OVERCURRENT LOW SIDE**  
**P0205-CYLINDER 5-INJECTOR CIRCUIT CURRENT DECREASE**  
**P0205-CYLINDER 5-INJECTOR CIRCUIT LOAD DROP**  
**P0205-CYLINDER 5-INJECTOR CIRCUIT OVERCURRENT HIGH SIDE**  
**P0205-CYLINDER 5-INJECTOR CIRCUIT OVERCURRENT LOW SIDE**

---

**Test Note: All symptoms listed above are diagnosed using the same tests. The title for the tests will be P0201-CYLINDER 1-INJECTOR CIRCUIT CURRENT DECREASE.**

---

**When Monitored and Set Condition:**

**P0201-CYLINDER 1-INJECTOR CIRCUIT CURRENT DECREASE**

When Monitored: With the engine running.

Set Condition: The ECM detects an incorrect rate of current decrease after injection occurs.

**P0201-CYLINDER 1-INJECTOR CIRCUIT CURRENT DECREASE —**  
**Continued**

---

**P0201-CYLINDER 1-INJECTOR CIRCUIT LOAD DROP**

When Monitored: With the engine running.

Set Condition: The ECM detects insufficient current through the injector driver when on.

**P0201-CYLINDER 1-INJECTOR CIRCUIT OVERCURRENT HIGH SIDE**

When Monitored: With the engine running.

Set Condition: The ECM detects excessive current on the common driver circuit.

**P0201-CYLINDER 1-INJECTOR CIRCUIT OVERCURRENT LOW SIDE**

When Monitored: With the engine running.

Set Condition: The ECM detects excessive current on the injector driver circuit.

**P0202-CYLINDER 2-INJECTOR CIRCUIT CURRENT DECREASE**

When Monitored: With the engine running.

Set Condition: The ECM detects an incorrect rate of current decrease after injection occurs.

**P0202-CYLINDER 2-INJECTOR CIRCUIT LOAD DROP**

When Monitored: With the engine running.

Set Condition: The ECM detects insufficient current through the injector driver when on.

**P0202-CYLINDER 2-INJECTOR CIRCUIT OVERCURRENT HIGH SIDE**

When Monitored: With the engine running.

Set Condition: The ECM detects excessive current on the common driver circuit.

**P0202-CYLINDER 2-INJECTOR CIRCUIT OVERCURRENT LOW SIDE**

When Monitored: With the engine running.

Set Condition: The ECM detects excessive current on the injector driver circuit.

**P0203-CYLINDER 3-INJECTOR CIRCUIT CURRENT DECREASE**

When Monitored: With the engine running.

Set Condition: The ECM detects an incorrect rate of current decrease after injection occurs.

**P0203-CYLINDER 3-INJECTOR CIRCUIT LOAD DROP**

When Monitored: With the engine running.

Set Condition: The ECM detects insufficient current through the injector driver when on.

**P0203-CYLINDER 3-INJECTOR CIRCUIT OVERCURRENT HIGH SIDE**

When Monitored: With the engine running.

Set Condition: The ECM detects excessive current on the common driver circuit.

**P0201-CYLINDER 1-INJECTOR CIRCUIT CURRENT DECREASE —  
Continued****P0203-CYLINDER 3-INJECTOR CIRCUIT OVERCURRENT LOW SIDE**

When Monitored: With the engine running.

Set Condition: The ECM detects excessive current on the injector driver circuit.

**P0204-CYLINDER 4-INJECTOR CIRCUIT CURRENT DECREASE**

When Monitored: With the engine running.

Set Condition: The ECM detects an incorrect rate of current decrease after injection occurs.

**P0204-CYLINDER 4-INJECTOR CIRCUIT LOAD DROP**

When Monitored: With the engine running.

Set Condition: The ECM detects insufficient current through the injector driver when on.

**P0204-CYLINDER 4-INJECTOR CIRCUIT OVERCURRENT HIGH SIDE**

When Monitored: With the engine running.

Set Condition: The ECM detects excessive current on the common driver circuit.

**P0204-CYLINDER 4-INJECTOR CIRCUIT OVERCURRENT LOW SIDE**

When Monitored: With the engine running.

Set Condition: The ECM detects excessive current on the injector driver circuit.

**P0205-CYLINDER 5-INJECTOR CIRCUIT CURRENT DECREASE**

When Monitored: With the engine running.

Set Condition: The ECM detects an incorrect rate of current decrease after injection occurs.

**P0205-CYLINDER 5-INJECTOR CIRCUIT LOAD DROP**

When Monitored: With the engine running.

Set Condition: The ECM detects insufficient current through the injector driver when on.

**P0205-CYLINDER 5-INJECTOR CIRCUIT OVERCURRENT HIGH SIDE**

When Monitored: With the engine running.

Set Condition: The ECM detects excessive current on the common driver circuit.

**P0205-CYLINDER 5-INJECTOR CIRCUIT OVERCURRENT LOW SIDE**

When Monitored: With the engine running.

Set Condition: The ECM detects excessive current on the injector driver circuit.



**P0201-CYLINDER 1-INJECTOR CIRCUIT CURRENT DECREASE** —  
Continued

<b>POSSIBLE CAUSES</b>
ENGINE CONTROL MODULE
INTERMITTENT CONDITION
FUEL INJECTOR CONTROL CIRCUIT SHORTED TO VOLTAGE
COMMON DRIVER CIRCUIT SHORTED TO VOLTAGE
FUEL INJECTOR CONTROL CIRCUIT SHORTED TO GROUND
COMMON DRIVER CIRCUIT SHORTED TO GROUND
FUEL INJECTOR CIRCUITS SHORTED TOGETHER
FUEL INJECTOR CONTROL CIRCUIT OPEN
COMMON DRIVER CIRCUIT OPEN
FUEL INJECTOR

<b>TEST</b>	<b>ACTION</b>	<b>APPLICABILITY</b>
1	Turn the ignition on. With the DRBIII®, erase the ECM DTCs. Test drive the vehicle. With the DRBIII®, read the ECM DTCs. Did this DTC set again?  Yes → Go To 2  No → Go To 10	All
2	Turn the ignition off. Disconnect the appropriate Cylinder Fuel Injector harness connector. Disconnect the ECM harness connectors. Remove the ASD Relay from the PDC. Connect a jumper wire between cavity 30 and cavity 87 of the ASD Relay connector. Turn the ignition on. Measure the voltage of the appropriate Fuel Injector Control circuit. Is the voltage above 1.0 volt?  Yes → Repair the Fuel Injector Control circuit for a short to voltage. Perform ROAD TEST VERIFICATION - VER-2.  No → Go To 3	All
3	Turn the ignition off. Disconnect the Cylinder Fuel Injector harness connector. Disconnect the ECM harness connectors. Remove the ASD Relay from the PDC. Connect a jumper wire between cavity 30 and cavity 87 of the ASD Relay connector. Turn the ignition on. Measure the voltage of the Common Driver circuit. Is the voltage above 1.0 volt?  Yes → Repair the Common Driver circuit for a short to voltage. Perform ROAD TEST VERIFICATION - VER-2.  No → Go To 4	All

## P0201-CYLINDER 1-INJECTOR CIRCUIT CURRENT DECREASE — Continued

TEST	ACTION	APPLICABILITY
4	Turn the ignition off. Disconnect the ECM harness connectors. Disconnect the Cylinder Fuel Injector harness connector. Measure the resistance between ground and the Fuel Injector Control circuit. Is the resistance below 1000 ohms?  Yes → Repair the Fuel Injector Control circuit for a short to ground. Perform ROAD TEST VERIFICATION - VER-2.  No → Go To 5	All
5	Turn the ignition off. Disconnect the ECM harness connectors. Disconnect the Cylinder Fuel Injector harness connector. Measure the resistance between ground and the Common Driver circuit. Is the resistance below 1000 ohms?  Yes → Repair the Common Driver circuit for a short to ground. Perform ROAD TEST VERIFICATION - VER-2.  No → Go To 6	All
6	Turn the ignition off. Disconnect the ECM harness connectors. Disconnect the Cylinder Fuel Injector harness connector. Measure the resistance between the Fuel Injector Control circuit and the Common Driver circuit. Is the resistance below 1000 ohms?  Yes → Repair the Fuel Injector Control circuit and Common Driver circuit for a short together. Perform ROAD TEST VERIFICATION - VER-2.  No → Go To 7	All
7	Turn the ignition off. Disconnect the ECM harness connectors. Disconnect the Cylinder Fuel Injector harness connector. Measure the resistance of the Fuel Injector Control circuit. Is the resistance below 10 ohms?  Yes → Go To 8  No → Repair the Fuel Injector Control circuit for an open. Perform ROAD TEST VERIFICATION - VER-2.	All
8	Turn the ignition off. Disconnect the ECM harness connectors. Disconnect the Cylinder Fuel Injector harness connector. Measure the resistance of the Common Driver circuit. Is the resistance below 10 ohms?  Yes → Go To 9  No → Repair the Common Driver circuit for an open. Perform ROAD TEST VERIFICATION - VER-2.	All

**P0201-CYLINDER 1-INJECTOR CIRCUIT CURRENT DECREASE —**  
**Continued**

TEST	ACTION	APPLICABILITY
9	<p>Turn the ignition off.                      Replace the Cylinder Fuel Injector in accordance with the Service Information.                      With the DRBIII®, erase the ECM DTCs.                      Test drive the vehicle.                      With the DRBIII®, read the ECM DTCs.                      Does the DRBIII® display this DTC?</p> <p>Yes → Replace and program the Engine Control Module in accordance with the Service Information.                      Perform ROAD TEST VERIFICATION - VER-2.</p> <p>No → The repair is complete.                      Perform ROAD TEST VERIFICATION - VER-2.</p>	All
10	<p><b>WARNING: WHEN THE ENGINE IS OPERATING, DO NOT STAND IN A DIRECT LINE WITH THE FAN. DO NOT PUT YOUR HANDS NEAR THE PULLEYS, BELTS OR FAN. DO NOT WEAR LOOSE CLOTHING.</b></p> <p><b>NOTE: The conditions that set the DTC are not present at this time. The following list may help in identifying the intermittent condition.</b></p> <p>With the engine running at normal operating temperature, monitor the DRB parameters related to the DTC while wiggling the wiring harness. Look for parameter values to change and/or a DTC to set.                      Review the DTC When Monitored and Set Conditions. If possible, try to duplicate the conditions under which the DTC was set.                      Refer to any Technical Service Bulletins (TSB) that may apply.                      Visually inspect the related wiring harness. Look for any chafed, pierced, pinched, or partially broken wires.                      Visually inspect the related wiring harness connectors. Look for broken, bent, pushed out, or corroded terminals.                      Were any of the above conditions present?</p> <p>Yes → Repair as necessary.                      Perform ROAD TEST VERIFICATION - VER-2.</p> <p>No → Test Complete.</p>	All

**Symptom:**

**P0235-BOOST PRESSURE SENSOR PLAUSIBILITY**

**When Monitored and Set Condition:**

**P0235-BOOST PRESSURE SENSOR PLAUSIBILITY**

When Monitored: With the engine speed below 800 rpm.

Set Condition: When the engine is idling, the boost pressure sensor input differs from the barometric pressure sensor input by 2.17 psi for at least 6 seconds.

**POSSIBLE CAUSES**

INTERMITTENT CONDITION  
 HIGH RESISTANCE IN THE BOOST PRESSURE SENSOR SIGNAL CIRCUIT  
 HIGH RESISTANCE IN THE BOOST PRESSURE SENSOR GROUND CIRCUIT  
 HIGH RESISTANCE IN THE 5-VOLT SUPPLY CIRCUIT  
 BOOST PRESSURE SENSOR  
 ENGINE CONTROL MODULE

TEST	ACTION	APPLICABILITY
1	<p><b>NOTE: If DTC P0641 or P0651 is present with this DTC, diagnose DTCs P0641 and P0651 before diagnosing this DTC.</b>                      Turn the ignition on.                      With the DRB, erase ECM DTCs.                      Turn the ignition off, wait 30 seconds, then start and idle the engine for at least 30 seconds.  <b>NOTE: Engine idle speed must be below 870 RPM.</b>                      With the DRB, read ECM DTCs.                      Did this DTC set again?</p> <p>Yes → Go To 2                      No → Go To 6</p>	All
2	<p>Turn the ignition off.                      Disconnect the Boost Pressure Sensor harness connector.                      Disconnect the ECM harness connectors.                      Measure the resistance of the Boost Pressure Sensor Signal circuit.                      Is the resistance below 5.0 ohms?</p> <p>Yes → Go To 3                      No → Repair the Boost Pressure Sensor Signal circuit for high resistance.                      Perform ROAD TEST VERIFICATION - VER-2.</p>	All

**P0235-BOOST PRESSURE SENSOR PLAUSIBILITY — Continued**

TEST	ACTION	APPLICABILITY
3	<p>Turn the ignition off.                      Disconnect the Boost Pressure Sensor harness connector.                      Disconnect the ECM harness connectors.                      Measure the resistance of the Sensor Ground circuit.                      Is the resistance below 5.0 ohms?</p> <p>Yes → Go To 4</p> <p>No → Repair the Boost Pressure Sensor Ground circuit for high resistance.                      Perform ROAD TEST VERIFICATION - VER-2.</p>	All
4	<p>Turn the ignition off.                      Disconnect the Boost Pressure Sensor harness connector.                      Disconnect the ECM harness connectors.                      Measure the resistance of the 5-Volt Supply circuit.                      Is the resistance below 5.0 ohms?</p> <p>Yes → Go To 5</p> <p>No → Repair the 5-Volt Supply circuit for high resistance.                      Perform ROAD TEST VERIFICATION - VER-2.</p>	All
5	<p>Turn the ignition off.                      Replace the Boost Pressure Sensor.                      Turn the ignition on.                      With the DRB, erase ECM DTCs.                      Test drive the vehicle, pausing several times to cycle the ignition.                      Monitor the DRB for ECM DTCs.                      Did this DTC set again?</p> <p>Yes → Replace and program the Engine Control Module in accordance with the Service Information.                      Perform ROAD TEST VERIFICATION - VER-2.</p> <p>No → The repair is complete.                      Perform ROAD TEST VERIFICATION - VER-2.</p>	All
6	<p><b>WARNING: WHEN THE ENGINE IS OPERATING, DO NOT STAND IN A DIRECT LINE WITH THE FAN. DO NOT PUT YOUR HANDS NEAR THE PULLEYS, BELTS OR FAN. DO NOT WEAR LOOSE CLOTHING.</b></p> <p><b>NOTE: The conditions that set the DTC are not present at this time. The following list may help in identifying the intermittent condition.</b></p> <p>With the engine running at normal operating temperature, monitor the DRB parameters related to the DTC while wiggling the wiring harness. Look for parameter values to change and/or a DTC to set.                      Review the DTC When Monitored and Set Conditions. If possible, try to duplicate the conditions under which the DTC was set.                      Refer to any Technical Service Bulletins (TSB) that may apply.                      Visually inspect the related wiring harness. Look for any chafed, pierced, pinched, or partially broken wires.                      Visually inspect the related wiring harness connectors. Look for broken, bent, pushed out, or corroded terminals.                      Were any of the above conditions present?</p> <p>Yes → Repair as necessary.                      Perform ROAD TEST VERIFICATION - VER-2.</p> <p>No → Test Complete.</p>	All

**Symptom:****P0235-BOOST PRESSURE SENSOR SIGNAL VOLTAGE TOO HIGH****When Monitored and Set Condition:****P0235-BOOST PRESSURE SENSOR SIGNAL VOLTAGE TOO HIGH**

When Monitored: With the ignition on.

Set Condition: The Boost Pressure Sensor Signal voltage exceeds 4.85 volts for at least 2 seconds.

**POSSIBLE CAUSES**

INTERMITTENT CONDITION

5-VOLT SUPPLY CIRCUIT SHORTED TO VOLTAGE

BOOST PRESSURE SENSOR GROUND CIRCUIT OPEN

BOOST PRESSURE SENSOR SIGNAL CIRCUIT SHORTED TO VOLTAGE

BOOST PRESSURE SENSOR

POOR CONNECTOR TERMINAL CONTACT

ENGINE CONTROL MODULE (5-VOLT SUPPLY SHORTED TO VOLTAGE)

ENGINE CONTROL MODULE (INTERNAL)

ENGINE CONTROL MODULE (SENSOR SIGNAL SHORTED TO VOLTAGE)

TEST	ACTION	APPLICABILITY
1	<p><b>NOTE: Ensure all turbocharger inlet and outlet tubes are connected properly, without damage and restriction before continuing with this test. Also ensure the wastegate actuator and actuator rod are attached and functioning properly.</b></p> <p><b>NOTE: If a P0243 DTC is present with this DTC, diagnose P0243 DTC before continuing.</b></p> <p>Turn the ignition on.            With the DRB, read the Boost Pressure Sensor voltage.  <b>NOTE: Ensure the turbocharger wastegate is operating properly. This code can be set if turbocharger boost pressure is too high.</b></p> <p>Is the voltage above 4.85 volts?</p> <p>Yes → Go To 2            No → Go To 9</p>	All
2	<p>Turn the ignition off.            Disconnect the Boost Pressure Sensor harness connector.            Turn the ignition on.            Measure the voltage between ground and the Boost Pressure Sensor 5-volt Supply circuit.            Is the voltage above 5.2 volts?</p> <p>Yes → Go To 3            No → Go To 4</p>	All

**P0235-BOOST PRESSURE SENSOR SIGNAL VOLTAGE TOO HIGH — Continued**

TEST	ACTION	APPLICABILITY
3	Turn the ignition off. Disconnect the Boost Pressure Sensor harness connector. Disconnect the ECM harness connectors. Remove the ASD Relay from the PDC. Connect a jumper wire between cavity 30 and cavity 87 of the ASD Relay connector. Turn the ignition on. Measure the voltage between ground and the 5-volt Supply circuit. Is the voltage above 1.0 volt?  Yes → Repair the 5-volt Supply circuit for a short to voltage. Perform ROAD TEST VERIFICATION - VER-2.  No → Replace and program the Engine Control Module in accordance with the Service Information. Perform ROAD TEST VERIFICATION - VER-2.	All
4	Turn the ignition off. Disconnect the Boost Pressure Sensor harness connector. Turn the ignition on. Measure the voltage between ground and the Boost Pressure Sensor Signal circuit. Is the voltage above 1.0 volt?  Yes → Go To 5  No → Go To 6	All
5	Turn the ignition off. Disconnect the Boost Pressure Sensor harness connector. Disconnect the ECM harness connectors. Remove the ASD Relay from the PDC. Connect a jumper wire between cavity 30 and cavity 87 of the ASD Relay connector. Turn the ignition on. Measure the voltage between ground and the Boost Pressure Sensor Signal circuit. Is the voltage above 1.0 volt?  Yes → Repair the Boost Pressure Sensor Signal circuit for a short to voltage. Perform ROAD TEST VERIFICATION - VER-2.  No → Replace and program the Engine Control Module in accordance with the Service Information. Perform ROAD TEST VERIFICATION - VER-2.	All
6	Turn the ignition off. Disconnect the Boost Pressure Sensor harness connector. Disconnect the ECM harness connectors. Measure the resistance of the Sensor Ground circuit. Is the resistance below 5.0 ohms?  Yes → Go To 7  No → Repair the Boost Pressure Sensor Ground circuit for an open. Perform ROAD TEST VERIFICATION - VER-2.	All

## P0235-BOOST PRESSURE SENSOR SIGNAL VOLTAGE TOO HIGH — Continued

TEST	ACTION	APPLICABILITY
7	Turn the ignition off. <b>NOTE: Ensure all harness connectors are connected.</b> Turn the ignition on. Measure the voltage of the Boost Pressure Sensor Signal circuit by back probing ECM harness connector C1, cavity 11. Is the voltage above 4.85 volts?  Yes → Replace the Boost Pressure Sensor. Perform ROAD TEST VERIFICATION - VER-2.  No → Go To 8	All
8	Turn the ignition on. With the DRB, read ECM DTCs. Did this DTC set again?  Yes → Replace and program the Engine Control Module in accordance with the Service Information. Perform ROAD TEST VERIFICATION - VER-2.  No → Ensure good terminal contact between the Turbocharger Boost Pressure Sensor harness connector and the sensor. The repair is complete. Perform ROAD TEST VERIFICATION - VER-2.	All
9	<b>WARNING: WHEN THE ENGINE IS OPERATING, DO NOT STAND IN A DIRECT LINE WITH THE FAN. DO NOT PUT YOUR HANDS NEAR THE PULLEYS, BELTS OR FAN. DO NOT WEAR LOOSE CLOTHING.</b> <b>NOTE: The conditions that set the DTC are not present at this time. The following list may help in identifying the intermittent condition.</b> With the engine running at normal operating temperature, monitor the DRB parameters related to the DTC while wiggling the wiring harness. Look for parameter values to change and/or a DTC to set. Review the DTC When Monitored and Set Conditions. If possible, try to duplicate the conditions under which the DTC was set. Refer to any Technical Service Bulletins (TSB) that may apply. Visually inspect the related wiring harness. Look for any chafed, pierced, pinched, or partially broken wires. Visually inspect the related wiring harness connectors. Look for broken, bent, pushed out, or corroded terminals. Were any of the above conditions present?  Yes → Repair as necessary. Perform ROAD TEST VERIFICATION - VER-2.  No → Test Complete.	All



**Symptom:**

**P0235-BOOST PRESSURE SENSOR SIGNAL VOLTAGE TOO LOW**

**When Monitored and Set Condition:**

**P0235-BOOST PRESSURE SENSOR SIGNAL VOLTAGE TOO LOW**

When Monitored: With the ignition on.

Set Condition: The Turbocharger Boost Pressure Sensor Signal voltage is below 0.30 volt for at least 2 seconds.

**POSSIBLE CAUSES**

INTERMITTENT CONDITION  
 5-VOLT SUPPLY CIRCUIT OPEN  
 BOOST PRESSURE SENSOR  
 BOOST PRESSURE SENSOR SIGNAL CIRCUIT SHORTED TO GROUND  
 BOOST PRESSURE SENSOR SIGNAL AND GROUND CIRCUITS SHORTED TOGETHER  
 BOOST PRESSURE SENSOR SIGNAL CIRCUIT OPEN  
 ENGINE CONTROL MODULE

TEST	ACTION	APPLICABILITY
1	Turn the ignition on. With the DRB, read the Turbocharger Boost Pressure Sensor voltage. Is the voltage below 0.3 volt?  Yes → Go To 2 No → Go To 8	All
2	Turn the ignition off. Disconnect the Boost Pressure Sensor harness connector. Turn the ignition on. Measure the voltage between ground and the 5-volt Supply circuit. Is the voltage above 4.9 volt?  Yes → Go To 3 No → Repair the 5-volt Supply circuit for an open. Perform ROAD TEST VERIFICATION - VER-2.	All
3	Turn the ignition off. Disconnect the Boost Pressure Sensor harness connector. Turn the ignition on. Connect a jumper wire between the Boost Pressure Sensor Signal and 5-volt Supply circuits. With the DRB, read the Boost Pressure Sensor voltage. Is the Boost Pressure Sensor voltage above 4.5 volts?  Yes → Replace the Boost Pressure Sensor. Perform ROAD TEST VERIFICATION - VER-2.  No → Go To 4	All

## P0235-BOOST PRESSURE SENSOR SIGNAL VOLTAGE TOO LOW — Continued

TEST	ACTION	APPLICABILITY
4	Turn the ignition off. Disconnect the Boost Pressure Sensor harness connector. Disconnect the ECM harness connectors. Measure the resistance between ground and the Boost Pressure Sensor Signal circuit. Is the resistance above 100 kohms? Yes → Go To 5 No → Repair the Boost Pressure Sensor Signal circuit for a short to ground. Perform ROAD TEST VERIFICATION - VER-2.	All
5	Turn the ignition off. Disconnect the Boost Pressure Sensor harness connector. Disconnect the ECM harness connectors. Measure the resistance between the Boost Pressure Sensor Signal circuit and Sensor Ground circuit. Is the resistance above 100 kohms? Yes → Go To 6 No → Repair the Boost Pressure Sensor Signal circuit for a short to the Sensor Ground circuit. Perform ROAD TEST VERIFICATION - VER-2.	All
6	Turn the ignition off. Disconnect the Boost Pressure Sensor harness connector. Disconnect the ECM harness connectors. Measure the resistance of the Boost Pressure Sensor Signal circuit. Is the resistance below 5.0 ohms? Yes → Go To 7 No → Repair the Boost Pressure Sensor Signal circuit for an open. Perform ROAD TEST VERIFICATION - VER-2.	All
7	If there are no possible causes remaining, view repair. Repair Replace and program the Engine Control Module in accordance with the Service Information. Perform ROAD TEST VERIFICATION - VER-2.	All

**P0235-BOOST PRESSURE SENSOR SIGNAL VOLTAGE TOO LOW —  
Continued**

TEST	ACTION	APPLICABILITY
8	<p><b>WARNING: WHEN THE ENGINE IS OPERATING, DO NOT STAND IN A DIRECT LINE WITH THE FAN. DO NOT PUT YOUR HANDS NEAR THE PULLEYS, BELTS OR FAN. DO NOT WEAR LOOSE CLOTHING.</b></p> <p><b>NOTE: The conditions that set the DTC are not present at this time. The following list may help in identifying the intermittent condition.</b></p> <p>With the engine running at normal operating temperature, monitor the DRB parameters related to the DTC while wiggling the wiring harness. Look for parameter values to change and/or a DTC to set.</p> <p>Review the DTC When Monitored and Set Conditions. If possible, try to duplicate the conditions under which the DTC was set.</p> <p>Refer to any Technical Service Bulletins (TSB) that may apply.</p> <p>Visually inspect the related wiring harness. Look for any chafed, pierced, pinched, or partially broken wires.</p> <p>Visually inspect the related wiring harness connectors. Look for broken, bent, pushed out, or corroded terminals.</p> <p>Were any of the above conditions present?</p> <p>Yes → Repair as necessary. Perform ROAD TEST VERIFICATION - VER-2.</p> <p>No → Test Complete.</p>	All

**Symptom:**

**P0235-BOOST PRESSURE SENSOR SUPPLY VOLTAGE TOO HIGH OR LOW**

**When Monitored and Set Condition:**

**P0235-BOOST PRESSURE SENSOR SUPPLY VOLTAGE TOO HIGH OR LOW**

When Monitored: With the ignition on.

Set Condition: The Sensor Reference Voltage B voltage to the Boost Pressure Sensor is below 4.8 volts or above 5.2 volts for at least 100 ms.

**POSSIBLE CAUSES**

INTERMITTENT CONDITION  
 APP SENSOR 5-VOLT SUPPLY CIRCUIT SHORTED TO GROUND  
 APP SENSOR 5-VOLT SUPPLY CIRCUIT SHORTED TO VOLTAGE  
 SENSOR REFERENCE VOLTAGE B CIRCUIT SHORTED TO GROUND  
 SENSOR REFERENCE VOLTAGE B CIRCUIT SHORTED TO SENSOR GROUND  
 SENSOR REFERENCE VOLTAGE B CIRCUIT SHORTED TO VOLTAGE  
 ENGINE CONTROL MODULE

TEST	ACTION	APPLICABILITY
1	<p><b>NOTE: If DTC P0641 or P0651 is present with this DTC, diagnose DTCs P0641 and P0651 before diagnosing this DTC.</b></p> <p>Turn the ignition on.                      With the DRB, erase ECM DTCs.                      Turn the ignition off, wait 30 seconds, then turn the ignition on.                      With the DRB, read ECM DTCs.                      Did this DTC set again?</p> <p>Yes → Go To 2                      No → Go To 7</p>	All
2	<p>Turn the ignition off.                      Disconnect the Boost Pressure Sensor harness connector.                      Disconnect the ECM harness connectors.                      Remove the ASD Relay from the PDC.                      Connect a jumper wire between cavity 30 and cavity 87 of the ASD Relay connector.                      Turn the ignition on.                      Measure the voltage between ground and the Sensor Reference Voltage B circuit at the Boost Pressure Sensor harness connector.                      Is the voltage above 1.0 volt?</p> <p>Yes → Repair the Sensor Reference Voltage B circuit for a short to voltage.                      Perform ROAD TEST VERIFICATION - VER-2.</p> <p>No → Go To 3</p>	All

**P0235-BOOST PRESSURE SENSOR SUPPLY VOLTAGE TOO HIGH OR LOW — Continued**

TEST	ACTION	APPLICABILITY
3	Turn the ignition off. Disconnect the Boost Pressure Sensor harness connector. Disconnect the ECM harness connectors. Measure the resistance between ground and the Sensor Reference Voltage B circuit at the Boost Pressure Sensor harness connector. Is the resistance above 1000 ohms?  Yes → Go To 4  No → Repair the Sensor Reference Voltage B circuit for a short to ground. Perform ROAD TEST VERIFICATION - VER-2.	All
4	Turn the ignition off. Disconnect the Boost Pressure Sensor harness connector. Disconnect the ECM harness connectors. Measure the resistance between the Sensor Ground circuit and the Sensor Reference Voltage B circuit at the Boost Pressure Sensor harness connector. Is the resistance above 1000 ohms?  Yes → Go To 5  No → Repair the Sensor Reference Voltage B circuit for a short to the Sensor Ground circuit. Perform ROAD TEST VERIFICATION - VER-2.	All
5	Turn the ignition off. Disconnect the APP Sensor harness connector. Disconnect the ECM harness connectors. Measure the resistance between ground and the 5-volt Supply circuit at the APP Sensor harness connector. Is the resistance above 1000 ohms?  Yes → Go To 6  No → Repair the APP Sensor 5-volt Supply circuit for a short to ground. Perform ROAD TEST VERIFICATION - VER-2.	All
6	Turn the ignition off. Disconnect the APP Sensor harness connector. Disconnect the ECM harness connectors. Remove the ASD Relay from the PDC. Connect a jumper wire between cavity 30 and cavity 87 of the ASD Relay connector. Turn the ignition on. Measure the voltage between ground and the 5-volt Supply circuit at the APP Sensor harness connector. Is the voltage above 1.0 volt?  Yes → Repair the APP Sensor 5-volt Supply circuit for a short to voltage. Perform ROAD TEST VERIFICATION - VER-2.  No → Replace and program the Engine Control Module in accordance with the Service Information. Perform ROAD TEST VERIFICATION - VER-2.	All

**P0235-BOOST PRESSURE SENSOR SUPPLY VOLTAGE TOO HIGH OR LOW — Continued**

TEST	ACTION	APPLICABILITY
7	<p><b>WARNING: WHEN THE ENGINE IS OPERATING, DO NOT STAND IN A DIRECT LINE WITH THE FAN. DO NOT PUT YOUR HANDS NEAR THE PULLEYS, BELTS OR FAN. DO NOT WEAR LOOSE CLOTHING.</b></p> <p><b>NOTE: The conditions that set the DTC are not present at this time. The following list may help in identifying the intermittent condition.</b></p> <p>With the engine running at normal operating temperature, monitor the DRB parameters related to the DTC while wiggling the wiring harness. Look for parameter values to change and/or a DTC to set.</p> <p>Review the DTC When Monitored and Set Conditions. If possible, try to duplicate the conditions under which the DTC was set.</p> <p>Refer to any Technical Service Bulletins (TSB) that may apply.</p> <p>Visually inspect the related wiring harness. Look for any chafed, pierced, pinched, or partially broken wires.</p> <p>Visually inspect the related wiring harness connectors. Look for broken, bent, pushed out, or corroded terminals.</p> <p>Were any of the above conditions present?</p> <p style="padding-left: 40px;">Yes → Repair as necessary. Perform ROAD TEST VERIFICATION - VER-2.</p> <p style="padding-left: 40px;">No → Test Complete.</p>	All

**Symptom:**

**P0243-TURBOCHARGER WASTEGATE SOLENOID CIRCUIT OPEN CIRCUIT**

**When Monitored and Set Condition:**

**P0243-TURBOCHARGER WASTEGATE SOLENOID CIRCUIT OPEN CIRCUIT**

When Monitored: With the ignition on.

Set Condition: The ECM detects an open or short to ground on the Turbocharger Wastegate Solenoid Control circuit.

<b>POSSIBLE CAUSES</b>	
INTERMITTENT CONDITION	
ASD RELAY OUTPUT CIRCUIT OPEN	
TURBOCHARGER WASTEGATE SOLENOID CONTROL CIRCUIT SHORTED TO GROUND	
TURBOCHARGER WASTEGATE SOLENOID CONTROL CKT OPEN	
TURBOCHARGER WASTEGATE SOLENOID	
ENGINE CONTROL MODULE	

<b>TEST</b>	<b>ACTION</b>	<b>APPLICABILITY</b>
1	Turn the ignition on. With the DRB, erase ECM DTCs. Test drive the vehicle. Monitor the DRB for ECM DTCs. Did this DTC set again?  Yes → Go To 2  No → Go To 7	All
2	Turn the ignition off. Disconnect the Turbocharger Wastegate Solenoid harness connector. Turn the ignition on. Using a 12-volt test light connected to ground, check the ASD Relay Output circuit. Does the test light illuminate brightly?  Yes → Go To 3  No → Repair the ASD Relay Output circuit for an open. Perform ROAD TEST VERIFICATION - VER-2.	All

**P0243-TURBOCHARGER WASTEGATE SOLENOID CIRCUIT OPEN CIRCUIT — Continued**

TEST	ACTION	APPLICABILITY
3	Turn the ignition off. Disconnect the Turbocharger Wastegate Solenoid harness connector. Disconnect the ECM harness connectors. Measure the resistance between ground and the Turbocharger Wastegate Solenoid Control circuit. Is the resistance above 100 kohms?  Yes → Go To 4  No → Repair the Turbocharger Wastegate Solenoid Control circuit for a short to ground. Perform ROAD TEST VERIFICATION - VER-2.	All
4	Turn the ignition off. Disconnect the Turbocharger Wastegate Solenoid harness connector. Disconnect the ECM harness connectors. Measure the resistance of the Turbocharger Wastegate Solenoid Control circuit. Is the resistance below 5.0 ohms?  Yes → Go To 5  No → Repair the Turbocharger Wastegate Solenoid Control circuit for an open. Perform ROAD TEST VERIFICATION - VER-2.	All
5	Turn the ignition off. Install a substitute Turbocharger Wastegate Solenoid in place of the vehicle's Turbocharger Wastegate Solenoid. <b>NOTE: Ensure the ECM and Turbocharger Wastegate Solenoid harness connectors are connected.</b> Turn the ignition on. With the DRB, check for this DTC to set again. Did this DTC set again?  Yes → Go To 6  No → Replace the Turbocharger Wastegate Solenoid. Perform ROAD TEST VERIFICATION - VER-2.	All
6	If there are no possible causes remaining, view repair.  Repair Replace and program the Engine Control Module in accordance with the Service Information. Perform ROAD TEST VERIFICATION - VER-2.	All



**P0243-TURBOCHARGER WASTEGATE SOLENOID CIRCUIT OPEN CIRCUIT — Continued**

TEST	ACTION	APPLICABILITY
7	<p><b>WARNING: WHEN THE ENGINE IS OPERATING, DO NOT STAND IN A DIRECT LINE WITH THE FAN. DO NOT PUT YOUR HANDS NEAR THE PULLEYS, BELTS OR FAN. DO NOT WEAR LOOSE CLOTHING.</b></p> <p><b>NOTE: The conditions that set the DTC are not present at this time. The following list may help in identifying the intermittent condition.</b></p> <p>With the engine running at normal operating temperature, monitor the DRB parameters related to the DTC while wiggling the wiring harness. Look for parameter values to change and/or a DTC to set.</p> <p>Review the DTC When Monitored and Set Conditions. If possible, try to duplicate the conditions under which the DTC was set.</p> <p>Refer to any Technical Service Bulletins (TSB) that may apply.</p> <p>Visually inspect the related wiring harness. Look for any chafed, pierced, pinched, or partially broken wires.</p> <p>Visually inspect the related wiring harness connectors. Look for broken, bent, pushed out, or corroded terminals.</p> <p>Were any of the above conditions present?</p> <p>Yes → Repair as necessary. Perform ROAD TEST VERIFICATION - VER-2.</p> <p>No → Test Complete.</p>	All

**Symptom:**

**P0243-TURBOCHARGER WASTEGATE SOLENOID CIRCUIT SHORT CIRCUIT**

**When Monitored and Set Condition:**

**P0243-TURBOCHARGER WASTEGATE SOLENOID CIRCUIT SHORT CIRCUIT**

When Monitored: With the ignition on.

Set Condition: The ECM detects a short to battery on the Turbocharger Wastegate Solenoid Control circuit.

<b>POSSIBLE CAUSES</b>	
INTERMITTENT CONDITION	
TURBOCHARGER WASTEGATE SOLENOID	
TURBOCHARGER WASTEGATE SOLENOID CONTROL SHORT TO VOLTAGE	
ENGINE CONTROL MODULE - INTERNAL	
ENGINE CONTROL MODULE - INTERNAL SHORT TO VOLTAGE	

<b>TEST</b>	<b>ACTION</b>	<b>APPLICABILITY</b>
1	Turn the ignition on. With the DRB, erase ECM DTCs. Test drive the vehicle and monitor the DRB for ECM DTCs. Did this DTC set again?  Yes → Go To 2  No → Go To 5	All
2	Turn the ignition off. Disconnect the Turbocharger Wastegate Solenoid harness connector. Turn the ignition on. With the DRB, erase ECM DTCs. Monitor the DRB for ECM DTCs. Does the DRB display P0243 TURBOCHARGER WASTEGATE OPEN CIRCUIT?  Yes → Replace the Turbocharger Wastegate Solenoid. Perform ROAD TEST VERIFICATION - VER-2.  No → Go To 3	All
3	Turn the ignition off. Disconnect the Turbocharger Wastegate Solenoid harness connector. Turn the ignition on. Measure the voltage of the Turbocharger Wastegate Solenoid Control circuit. Is the voltage below 0.5 volt?  Yes → Replace and program the Engine Control Module in accordance with the Service Information. Perform ROAD TEST VERIFICATION - VER-2.  No → Go To 4	All

**P0243-TURBOCHARGER WASTEGATE SOLENOID CIRCUIT SHORT CIRCUIT — Continued**

TEST	ACTION	APPLICABILITY
4	<p>Turn the ignition off.                      Disconnect the Turbocharger Wastegate Solenoid harness connector.                      Disconnect the ECM harness connectors.                      Remove the ASD Relay from the PDC.                      Connect a jumper wire between cavity 30 and cavity 87 of the ASD Relay connector.                      Turn the ignition on.                      Measure the voltage of the Turbocharger Wastegate Solenoid Control circuit.                      Is the voltage below 0.5 volt?</p> <p>Yes → Replace and program the Engine Control Module in accordance with the Service Information.                      Perform ROAD TEST VERIFICATION - VER-2.</p> <p>No → Repair the Turbocharger Wastegate Solenoid Control circuit for a short to voltage.                      Perform ROAD TEST VERIFICATION - VER-2.</p>	All
5	<p><b>WARNING: WHEN THE ENGINE IS OPERATING, DO NOT STAND IN A DIRECT LINE WITH THE FAN. DO NOT PUT YOUR HANDS NEAR THE PULLEYS, BELTS OR FAN. DO NOT WEAR LOOSE CLOTHING.</b></p> <p><b>NOTE: The conditions that set the DTC are not present at this time. The following list may help in identifying the intermittent condition.</b></p> <p>With the engine running at normal operating temperature, monitor the DRB parameters related to the DTC while wiggling the wiring harness. Look for parameter values to change and/or a DTC to set.                      Review the DTC When Monitored and Set Conditions. If possible, try to duplicate the conditions under which the DTC was set.                      Refer to any Technical Service Bulletins (TSB) that may apply.                      Visually inspect the related wiring harness. Look for any chafed, pierced, pinched, or partially broken wires.                      Visually inspect the related wiring harness connectors. Look for broken, bent, pushed out, or corroded terminals.                      Were any of the above conditions present?</p> <p>Yes → Repair as necessary.                      Perform ROAD TEST VERIFICATION - VER-2.</p> <p>No → Test Complete.</p>	All

**Symptom:**

**P0335-CKP SENSOR CIRCUIT DYNAMIC PLAUSIBILITY**

**When Monitored and Set Condition:**

**P0335-CKP SENSOR CIRCUIT DYNAMIC PLAUSIBILITY**

When Monitored: With the engine cranking or running.

Set Condition: The ECM detects a change in engine speed that has occurred more rapidly than is physically possible by the engine.

**POSSIBLE CAUSES**

ENGINE CONTROL MODULE  
 OPEN SHIELD CIRCUIT  
 REPLACE THE CRANKSHAFT POSITION SENSOR  
 INTERMITTENT CONDITION

TEST	ACTION	APPLICABILITY
1	<p><b>NOTE: This DTC indicates the Engine Speed Sensor has seen an engine speed above 5200 RPM. This can occur if errant noise is picked up on the CKP Sensor Signal circuit.</b></p> <p>Turn the ignition on.                      With the DRB, erase ECM DTCs.                      Test drive the vehicle and monitor the DRB for ECM DTCs.                      Did this DTC set again?</p> <p>Yes → Go To 2                      No → Go To 4</p>	All
2	<p>Turn the ignition off.                      Disconnect the ECM harness connectors.                      Disconnect the CKP Sensor harness connector.                      Measure the resistance of the Shield circuit.                      Is the resistance below 10.0 ohms?</p> <p>Yes → Go To 3                      No → Repair the Shield circuit for an open.                      Perform ROAD TEST VERIFICATION - VER-2.</p>	All

**P0335-CKP SENSOR CIRCUIT DYNAMIC PLAUSIBILITY — Continued**

TEST	ACTION	APPLICABILITY
3	<p>Replace the Crankshaft Position Sensor in accordance with the Service Information. With the DRB, erase ECM DTCs. Perform several drive cycles, turning the ignition off for at least 10 seconds between each drive cycle. Monitor the DRB for ECM DTCs. Did this DTC set again?</p> <p>Yes → Replace and program the Engine Control Module in accordance with the Service Information. Perform ROAD TEST VERIFICATION - VER-2.</p> <p>No → The repair is complete. Refer to the Service Information to check for engine mechanical problems that may have occurred due to excessive engine speed. Perform ROAD TEST VERIFICATION - VER-2.</p>	All
4	<p><b>CAUTION: Refer to the Service Information to check for engine mechanical problems that may have occurred due to excessive engine RPM.</b></p> <p><b>WARNING: WHEN THE ENGINE IS OPERATING, DO NOT STAND IN A DIRECT LINE WITH THE FAN. DO NOT PUT YOUR HANDS NEAR THE PULLEYS, BELTS OR FAN. DO NOT WEAR LOOSE CLOTHING.</b></p> <p><b>NOTE: The conditions that set the DTC are not present at this time. The following list may help in identifying the intermittent condition.</b></p> <p>With the engine running at normal operating temperature, monitor the DRB parameters related to the DTC while wiggling the wiring harness. Look for parameter values to change and/or a DTC to set. Review the DTC When Monitored and Set Conditions. If possible, try to duplicate the conditions under which the DTC was set. Refer to any Technical Service Bulletins (TSB) that may apply. Visually inspect the related wiring harness. Look for any chafed, pierced, pinched, or partially broken wires. Visually inspect the related wiring harness connectors. Look for broken, bent, pushed out, or corroded terminals. Check the CKP Sensor wiring harness for incorrect routing which may cause EMI interference. Were any of the above conditions present?</p> <p>Yes → Repair as necessary. Perform ROAD TEST VERIFICATION - VER-2.</p> <p>No → Test Complete.</p>	All

**Symptom:**

**P0340-CMP/CKP POSITION SENSOR CIRCUIT - CKP DYNAMIC PLAUSIBILITY**

**When Monitored and Set Condition:**

**P0340-CMP/CKP POSITION SENSOR CIRCUIT - CKP DYNAMIC PLAUSIBILITY**

When Monitored: The engine speed is above 790 RPM.

Set Condition: The ECM compares the current crankshaft RPM to the last calculated crankshaft RPM and the acceleration or deceleration is greater than is physically possible.

POSSIBLE CAUSES	
CHECK CRANKSHAFT POSITION SENSOR SIGNAL	
ENGINE CONTROL MODULE	
OPEN SHIELD CIRCUIT	
INTERMITTENT CONDITION	
CRANKSHAFT POSITION SENSOR SIGNAL CIRCUIT(S) SHORTED TO GROUND	
CKP SENSOR CIRCUITS SHORTED TOGETHER	
CKP SENSOR SIGNAL CIRCUITS OPEN	
CKP SENSOR SIGNAL CIRCUIT(S) SHORTED TO VOLTAGE	

TEST	ACTION	APPLICABILITY
1	Attempt to start the engine. Did the engine start?  Yes → Go To 2  No → Go To 3	All

**P0340-CMP/CKP POSITION SENSOR CIRCUIT - CKP DYNAMIC PLAUSIBILITY — Continued**

TEST	ACTION	APPLICABILITY
2	<p><b>WARNING: WHEN THE ENGINE IS OPERATING, DO NOT STAND IN A DIRECT LINE WITH THE FAN. DO NOT PUT YOUR HANDS NEAR THE PULLEYS, BELTS OR FAN. DO NOT WEAR LOOSE CLOTHING.</b></p> <p><b>NOTE: The conditions that set the DTC are not present at this time. The following list may help in identifying the intermittent condition.</b></p> <p>With the engine running at normal operating temperature, monitor the DRB parameters related to the DTC while wiggling the wiring harness. Look for parameter values to change and/or a DTC to set.</p> <p>Review the DTC When Monitored and Set Conditions. If possible, try to duplicate the conditions under which the DTC was set.</p> <p>Refer to any Technical Service Bulletins (TSB) that may apply.</p> <p>Visually inspect the related wiring harness. Look for any chafed, pierced, pinched, or partially broken wires.</p> <p>Visually inspect the related wiring harness connectors. Look for broken, bent, pushed out, or corroded terminals.</p> <p>Were any of the above conditions present?</p> <p style="padding-left: 40px;">Yes → Repair as necessary. Perform ROAD TEST VERIFICATION - VER-2.</p> <p style="padding-left: 40px;">No → Test Complete.</p>	All
3	<p>Turn the ignition off.</p> <p>Disconnect the CKP Sensor harness connector.</p> <p>Disconnect the ECM harness connectors.</p> <p>Measure the resistance between ground and the both of the CKP Sensor Signal circuits.</p> <p>Is the resistance above 1000 ohms for both measurements?</p> <p style="padding-left: 40px;">Yes → Go To 4</p> <p style="padding-left: 40px;">No → Repair the CKP Sensor Signal circuit(s) for a short to ground. Perform ROAD TEST VERIFICATION - VER-2.</p>	All
4	<p>Turn the ignition off.</p> <p>Disconnect the CKP Sensor harness connector.</p> <p>Disconnect the ECM harness connectors.</p> <p>Measure the resistance between the CKP Sensor Signal circuits.</p> <p>Is the resistance above 1000 ohms?</p> <p style="padding-left: 40px;">Yes → Go To 5</p> <p style="padding-left: 40px;">No → Repair the CKP Sensor Signal circuits for a short together. Perform ROAD TEST VERIFICATION - VER-2.</p>	All
5	<p>Turn the ignition off.</p> <p>Disconnect the CKP Sensor harness connector.</p> <p>Disconnect the ECM harness connectors.</p> <p>Measure the resistance of CKP Sensor Signal circuits.</p> <p>Is the resistance below 10.0 ohms for both measurements?</p> <p style="padding-left: 40px;">Yes → Go To 6</p> <p style="padding-left: 40px;">No → Repair the CKP Sensor Signal circuit(s) for an open. Perform ROAD TEST VERIFICATION - VER-2.</p>	All

## P0340-CMP/CKP POSITION SENSOR CIRCUIT - CKP DYNAMIC PLAUSIBILITY — Continued

TEST	ACTION	APPLICABILITY
6	Turn the ignition off. Disconnect the CKP Sensor harness connector. Disconnect the ECM harness connectors. Remove the ASD Relay from the PDC. Connect a jumper wire between cavity 30 and cavity 87 of the ASD Relay connector. Turn the ignition on. Measure the voltage of both CKP Sensor Signal circuits. Is the voltage below 1.0 volt for both measurements?  Yes → Go To 7  No → Repair the CKP Sensor Signal circuit(s) for a short to voltage. Perform ROAD TEST VERIFICATION - VER-2.	All
7	Turn the ignition off. Using the DRB lab scope, backprobe both of the CKP Sensor Signal circuits at the ECM harness connector. <b>NOTE: Refer to Charts and Graphs to view a correct CKP Sensor signal.</b> Start the engine, if the engine will not start, crank the engine for several seconds while monitoring the DRB. Does the DRB display a steady clean CKP Signal pattern for each circuit?  Yes → Go To 8  No → Replace the Crankshaft Position Sensor. Perform ROAD TEST VERIFICATION - VER-2.	All
8	Turn the ignition off. Disconnect the ECM harness connectors. Disconnect the CKP Sensor harness connector. Measure the resistance of the Shield circuit. Is the resistance below 10.0 ohms?  Yes → Replace and program the Engine Control Module in accordance with the Service Information. Perform ROAD TEST VERIFICATION - VER-2.  No → Repair the Shield circuit for an open. Perform ROAD TEST VERIFICATION - VER-2.	All



**Symptom:**

**P0340-CMP/CKP POSITION SENSOR CIRCUIT - CMP/CKP SYNC FAILURE**

**When Monitored and Set Condition:**

**P0340-CMP/CKP POSITION SENSOR CIRCUIT - CMP/CKP SYNC FAILURE**

When Monitored: With the engine running.

Set Condition: The ECM determines that the camshaft position sensor signal frequency is not plausible with the crankshaft position sensor signal frequency.

POSSIBLE CAUSES
CHECK CAMSHAFT POSITION SENSOR SIGNAL
CHECK CRANKSHAFT POSITION SENSOR SIGNAL
CHECKING CKP SENSOR FOR DAMAGE
CHECKING CMP SENSOR FOR DAMAGE
ENGINE CONTROL MODULE
GEAR ALIGNMENT
INTERMITTENT CONDITION

TEST	ACTION	APPLICABILITY
1	Turn the ignition on. With the DRBIII®, erase the ECM DTCs. Attempt to start the engine. With the DRBIII®, read the ECM DTCs. Does the DRB III display this DTC?  Yes → Go To 3 No → Go To 2	All
2	Turn the ignition on. With the DRBIII®, erase the ECM DTCs. Test drive the vehicle. With the DRBIII®, read the ECM DTCs. Does the DRB III display this DTC?  Yes → Go To 3 No → Go To 8	All
3	Turn the ignition off. Remove the CMP Sensor. Inspect the camshaft Position Sensor for conditions such as loose mounting screws, damage or debris, also check the camshaft for cracked teeth. Is there any evidence of these conditions?  Yes → Repair as necessary. Perform ROAD TEST VERIFICATION - VER-2.  No → Go To 4	All

## P0340-CMP/CKP POSITION SENSOR CIRCUIT - CMP/CKP SYNC FAILURE — Continued

TEST	ACTION	APPLICABILITY
4	Turn the ignition off. Remove the CKP Sensor. Inspect the Crankshaft Position Sensor for conditions such as loose mounting screws, damage or debris. Is there any evidence of these conditions?  Yes → Repair as necessary. Perform ROAD TEST VERIFICATION - VER-2.  No → Go To 5	All
5	Turn the ignition off. Using the DRB lab scope, backprobe the CMP Sensor Signal circuit at the CMP Sensor harness connector. Start the engine, if the engine will not start, crank the engine for several seconds while monitoring the DRB. <b>NOTE: Refer to Charts and Graphs to view a correct CMP Sensor signal.</b> Does the DRB display a steady clean CMP Signal pattern?  Yes → Go To 6  No → Perform Test for DTC P0340-Camshaft Position Sensor Circuit Static Plausibility. Perform ROAD TEST VERIFICATION - VER-2.	All
6	Turn the ignition off. Using the DRB lab scope, backprobe both of the CKP Sensor Signal circuits at the CKP Sensor harness connector. <b>NOTE: Refer to Charts and Graphs to view a correct CKP Sensor signal.</b> Start the engine, if the engine will not start, crank the engine for several seconds while monitoring the DRB. Does the DRB display a steady clean CKP Signal pattern for each circuit?  Yes → Go To 7  No → Perform Test for DTC P0340-Crankshaft Position Sensor Circuit Dynamic Plausibility. Perform ROAD TEST VERIFICATION - VER-2.	All
7	Refer to the Service Information and check alignment of the camshaft sprocket, crankshaft sprocket and injection pump sprocket. Are all of the sprockets aligned correctly?  Yes → Replace and program the Engine Control Module in accordance with the Service Information. Perform ROAD TEST VERIFICATION - VER-2.  No → Repair or adjust as necessary. Perform ROAD TEST VERIFICATION - VER-2.	All

**P0340-CMP/CKP POSITION SENSOR CIRCUIT - CMP/CKP SYNC FAILURE — Continued**

TEST	ACTION	APPLICABILITY
8	<p><b>WARNING: WHEN THE ENGINE IS OPERATING, DO NOT STAND IN A DIRECT LINE WITH THE FAN. DO NOT PUT YOUR HANDS NEAR THE PULLEYS, BELTS OR FAN. DO NOT WEAR LOOSE CLOTHING.</b></p> <p><b>NOTE: The conditions that set the DTC are not present at this time. The following list may help in identifying the intermittent condition.</b></p> <p>With the engine running at normal operating temperature, monitor the DRB parameters related to the DTC while wiggling the wiring harness. Look for parameter values to change and/or a DTC to set.</p> <p>Review the DTC When Monitored and Set Conditions. If possible, try to duplicate the conditions under which the DTC was set.</p> <p>Refer to any Technical Service Bulletins (TSB) that may apply.</p> <p>Visually inspect the related wiring harness. Look for any chafed, pierced, pinched, or partially broken wires.</p> <p>Visually inspect the related wiring harness connectors. Look for broken, bent, pushed out, or corroded terminals.</p> <p>Were any of the above conditions present?</p> <p style="padding-left: 40px;">Yes → Repair as necessary. Perform ROAD TEST VERIFICATION - VER-2.</p> <p style="padding-left: 40px;">No → Test Complete.</p>	All

**Symptom List:****P0340-CMP/CKP POSITION SENSOR CIRCUIT - SIGNAL FREQUENCY TOO HIGH****P0340-CMP/CKP POSITION SENSOR CIRCUIT - STATIC PLAUSIBILITY**

**Test Note: All symptoms listed above are diagnosed using the same tests. The title for the tests will be P0340-CMP/CKP POSITION SENSOR CIRCUIT - SIGNAL FREQUENCY TOO HIGH.**

**When Monitored and Set Condition:****P0340-CMP/CKP POSITION SENSOR CIRCUIT - SIGNAL FREQUENCY TOO HIGH**

When Monitored: With the engine running.

Set Condition: The ECM detects that engine speed is greater than 10,000 RPM.

**P0340-CMP/CKP POSITION SENSOR CIRCUIT - STATIC PLAUSIBILITY**

When Monitored: With the engine running.

Set Condition: The ECM detects the Camshaft Sensor Signal is missing while the engine is running.

**POSSIBLE CAUSES**

CHECKING FOR DAMAGE

ECM

SENSOR GROUND CIRCUIT OPEN

INTERMITTENT CONDITION

VERIFY ASD RELAY OUTPUT

CMP SENSOR SIGNAL CIRCUIT OPEN

CMP SENSOR SIGNAL CIRCUIT SHORTED TO GROUND

ECM SENSOR GROUND CIRCUIT OPEN

VERIFY CMP SENSOR OPERATION DURING CRANKING CRANK

CMP SENSOR SIGNAL CIRCUIT SHORTED TO THE SENSOR GROUND CIRCUIT

CMP SENSOR CIRCUIT SHORTED TO VOLTAGE

**P0340-CMP/CKP POSITION SENSOR CIRCUIT - SIGNAL FREQUENCY TOO HIGH — Continued**

TEST	ACTION	APPLICABILITY
1	<p><b>NOTE: The Timing Belt must be correctly installed and operational before diagnosis can be made. Refer to the Service Information to ensure the timing belt is properly installed.</b></p> <p>Turn the ignition on.                      With the DRBIII®, erase the ECM DTCs.                      Attempt to start the engine.                      With the DRBIII®, read the ECM DTCs.                      Does the DRBIII® display this DTC?</p> <p>Yes → Go To 3                      No → Go To 2</p>	All
2	<p>Turn the ignition on.                      With the DRBIII®, erase the ECM DTCs.                      Test drive the vehicle.                      With the DRBIII®, read the ECM DTCs.                      Does the DRBIII® display this DTC?</p> <p>Yes → Go To 3                      No → Go To 13</p>	All
3	<p>Turn the ignition off.                      Disconnect the CMP Sensor harness connector.                      Turn the ignition on.                      Using a 12-volt test light connected to ground, check the ASD Relay Output circuit in CMP Sensor harness connector.                      Does the test light illuminate brightly?</p> <p>Yes → Go To 4                      No → Repair the ASD Relay Output circuit for an open.                      Perform ROAD TEST VERIFICATION - VER-2.</p>	All
4	<p>Turn the ignition off.                      Disconnect the CMP Sensor harness connector.                      Turn the ignition on.                      Measure the voltage of the CMP Sensor Signal circuit.                      Is the voltage above 10.0 volts?</p> <p>Yes → Go To 5                      No → Go To 10</p>	All
5	<p>Turn the ignition off.                      Disconnect the CMP Sensor harness connector.                      Turn the ignition on.                      Using a 12-volt test light connected to ground, check the CMP Sensor Signal circuit.                      Is the test light on?</p> <p>Yes → Repair the CMP Sensor Signal circuit for a short to voltage.                      Perform ROAD TEST VERIFICATION - VER-2.                      No → Go To 6</p>	All

## P0340-CMP/CKP POSITION SENSOR CIRCUIT - SIGNAL FREQUENCY TOO HIGH — Continued

TEST	ACTION	APPLICABILITY
6	<p>Turn the ignition off.            Disconnect the CMP Sensor harness connector.            Disconnect the ECM harness connectors.            Measure the resistance of the Sensor Ground circuit between the CMP Sensor harness connector and the ECM harness connector.            Is the resistance below 10.0 ohms?</p> <p>Yes → Go To 7</p> <p>No → Repair the Sensor Ground circuit for an open.            Perform ROAD TEST VERIFICATION - VER-2.</p>	All
7	<p>Turn the ignition on.            Disconnect the IAT Sensor harness connector.            Disconnect the Camshaft Position Sensor harness connector.            Connect one end of a jumper wire to the IAT Sensor signal circuit in the IAT Sensor harness connector.            Connect the other end of the jumper wire to the Sensor Ground circuit in the Camshaft Position Sensor harness connector.            With the DRBIII® in Engine, Sensors, read the Intake Air Temp volts.            Is the voltage below 1.0 volt?</p> <p>Yes → Go To 8</p> <p>No → Replace and program the ECM in accordance with the Service Information.            Perform ROAD TEST VERIFICATION - VER-2.</p>	All
8	<p>Turn the ignition off.            Remove the CMP Sensor.            Inspect the camshaft for conditions such as loose mounting screws, damage, debris or cracked teeth.            Is there any evidence of these conditions?</p> <p>Yes → Repair as necessary.            Perform ROAD TEST VERIFICATION - VER-2.</p> <p>No → Go To 9</p>	All
9	<p>Turn the ignition off.            With the DRBIII® lab scope lead, backprobe the CMP Signal circuit.            Set the DRBIII® lab scope settings as follows: Time = 0.1s/Div, 20 volts scale, Offset = 0.00volts, Probe = X10, Coupling = DC.            While observing the DRBIII® display, crank the engine.  <b>NOTE: The DRBIII® should display a digital signal (square wave) similar to that shown in the support material.</b>            Does the DRBIII® display an uninterrupted digital signal (square wave)?</p> <p>Yes → Replace and program the Engine Control Module in accordance with the Service Information.            Perform ROAD TEST VERIFICATION - VER-2.</p> <p>No → Replace the Camshaft Position Sensor in accordance with the Service Information.            Perform ROAD TEST VERIFICATION - VER-2.</p>	All

**P0340-CMP/CKP POSITION SENSOR CIRCUIT - SIGNAL FREQUENCY TOO HIGH — Continued**

TEST	ACTION	APPLICABILITY
10	Turn the ignition off. Disconnect the CMP Sensor harness connector. Disconnect the ECM harness connectors. Measure the resistance of the CMP Sensor Signal circuit. Is the resistance below 10.0 ohms?  Yes → Go To 11  No → Repair the CMP Sensor Signal circuit for an open Perform ROAD TEST VERIFICATION - VER-2.	All
11	Turn the ignition off. Disconnect the CMP Sensor harness connector. Disconnect the ECM harness connectors. Measure the resistance between ground and the CMP Sensor Signal circuit. Is the resistance below 1000 ohms?  Yes → Repair the CMP Sensor Signal circuit for a short to ground. Perform ROAD TEST VERIFICATION - VER-2.  No → Go To 12	All
12	Turn the ignition off. Disconnect the CMP Sensor harness connector. Disconnect the ECM harness connectors. Measure the resistance between the CMP Sensor Signal circuit and the Sensor Ground circuit at the CMP Sensor harness connector. Is the resistance below 1000 ohms?  Yes → Repair the CMP Sensor Signal and Sensor Ground circuits for a short together. Perform ROAD TEST VERIFICATION - VER-2.  No → Replace and program the Engine Control Module in accordance with the Service Information. Perform ROAD TEST VERIFICATION - VER-2.	All
13	<p><b>WARNING: WHEN THE ENGINE IS OPERATING, DO NOT STAND IN A DIRECT LINE WITH THE FAN. DO NOT PUT YOUR HANDS NEAR THE PULLEYS, BELTS OR FAN. DO NOT WEAR LOOSE CLOTHING.</b></p> <p><b>NOTE: The conditions that set the DTC are not present at this time. The following list may help in identifying the intermittent condition.</b></p> With the engine running and at normal operating temperature, monitor the DRB parameters related to the DTC while wiggling the wiring harness. Look for parameter values to change and/or a DTC to set. Remove the CMP Sensor and the CKP Sensor, checking for loose mounting screws and debris on the sensor magnets that can corrupt the sensor signal. Review the DTC When Monitored and Set Conditions. If possible, try to duplicate the conditions under which the DTC was set. Refer to any Technical Service Bulletins (TSB) that may apply. Visually inspect the related wiring harness. Look for any chafed, pierced, pinched, or partially broken wires. Visually inspect the related wiring harness connectors. Look for broken, bent, pushed out, or corroded terminals. Were any of the above conditions present?  Yes → Repair as necessary. Perform ROAD TEST VERIFICATION - VER-2.  No → Test Complete.	All

**Symptom List:**

**P0380-GLOW PLUG 1 CONTROL CIRCUIT - OPEN CIRCUIT**  
**P0380-GLOW PLUG 1 CONTROL CIRCUIT - SHORT CIRCUIT**

**Test Note: All symptoms listed above are diagnosed using the same tests. The title for the tests will be P0380-GLOW PLUG 1 CONTROL CIRCUIT - OPEN CIRCUIT.**

**When Monitored and Set Condition:**

**P0380-GLOW PLUG 1 CONTROL CIRCUIT - OPEN CIRCUIT**

When Monitored: With the ignition on.

Set Condition: The ECM does not detect voltage on the Glow Plug Relay 1 Control circuit.

**P0380-GLOW PLUG 1 CONTROL CIRCUIT - SHORT CIRCUIT**

When Monitored: With the ignition off.

Set Condition: The ECM detects excessive current on the Glow Plug Relay 1 Control circuit.

**POSSIBLE CAUSES**

INTERMITTENT CONDITION  
 ASD RELAY OUTPUT CIRCUIT OPEN  
 SUBSTITUTE GLOW PLUG RELAY 1  
 GLOW PLUG RELAY 1 CONTROL CIRCUIT SHORTED TO VOLTAGE  
 GLOW PLUG RELAY 1 CONTROL CIRCUIT SHORTED TO GROUND  
 GLOW PLUG RELAY 1 CONTROL CIRCUIT OPEN  
 ENGINE CONTROL MODULE

TEST	ACTION	APPLICABILITY
1	Turn the ignition on. With the DRB, actuate Glow Plug Relay 1. Is Glow Plug Relay 1 clicking?  Yes → Go To 2  No → Go To 3	All



**P0380-GLOW PLUG 1 CONTROL CIRCUIT - OPEN CIRCUIT — Continued**

TEST	ACTION	APPLICABILITY
2	<p><b>WARNING: WHEN THE ENGINE IS OPERATING, DO NOT STAND IN A DIRECT LINE WITH THE FAN. DO NOT PUT YOUR HANDS NEAR THE PULLEYS, BELTS OR FAN. DO NOT WEAR LOOSE CLOTHING.</b></p> <p><b>NOTE: The conditions that set the DTC are not present at this time. The following list may help in identifying the intermittent condition.</b></p> <p>With the engine running at normal operating temperature, monitor the DRB parameters related to the DTC while wiggling the wiring harness. Look for parameter values to change and/or a DTC to set.</p> <p>Review the DTC When Monitored and Set Conditions. If possible, try to duplicate the conditions under which the DTC was set.</p> <p>Refer to any Technical Service Bulletins (TSB) that may apply.</p> <p>Visually inspect the related wiring harness. Look for any chafed, pierced, pinched, or partially broken wires.</p> <p>Visually inspect the related wiring harness connectors. Look for broken, bent, pushed out, or corroded terminals.</p> <p>Were any of the above conditions present?</p> <p style="padding-left: 40px;">Yes → Repair as necessary. Perform ROAD TEST VERIFICATION - VER-2.</p> <p style="padding-left: 40px;">No → Test Complete.</p>	All
3	<p>Turn the ignition off.</p> <p>Remove Glow Plug Relay 1 from the PDC.</p> <p>Turn the ignition on.</p> <p>Using a 12-volt test light connected to ground, check the ASD Relay Output circuit.</p> <p>Does the test light illuminate brightly?</p> <p style="padding-left: 40px;">Yes → Go To 4</p> <p style="padding-left: 40px;">No → Repair the ASD Relay Output circuit for an open. Perform ROAD TEST VERIFICATION - VER-2.</p>	All
4	<p>Turn the ignition off.</p> <p>Install a substitute relay in place of Glow Plug Relay 1.</p> <p>Perform several ignition key cycles, pausing for at least 10 seconds between each cycle.</p> <p>Turn the ignition on.</p> <p>With the DRB, read ECM DTCs.</p> <p>Did this DTC set again?</p> <p style="padding-left: 40px;">Yes → Go To 5</p> <p style="padding-left: 40px;">No → Replace Glow Plug Relay 1. Perform ROAD TEST VERIFICATION - VER-2.</p>	All
5	<p>Turn the ignition off.</p> <p>Disconnect the ECM harness connectors.</p> <p>Remove Glow Plug Relay 1 from the PDC.</p> <p>Remove the ASD Relay from the PDC.</p> <p>Connect a jumper wire between cavity 30 and cavity 87 of the ASD Relay connector.</p> <p>Turn the ignition on.</p> <p>Measure the voltage on the Glow Plug Relay 1 Control circuit.</p> <p>Is the voltage above 1.0 volt?</p> <p style="padding-left: 40px;">Yes → Repair the Glow Plug Relay 1 Control circuit for a short to voltage. Perform ROAD TEST VERIFICATION - VER-2.</p> <p style="padding-left: 40px;">No → Go To 6</p>	All

**P0380-GLOW PLUG 1 CONTROL CIRCUIT - OPEN CIRCUIT — Continued**

TEST	ACTION	APPLICABILITY
6	Turn the ignition off. Remove Glow Plug Relay 1 from the PDC. Disconnect the ECM harness connectors. Measure the resistance between ground and the Glow Plug Relay 1 Control circuit. Is the resistance above 1000 ohms?  Yes → Go To 7  No → Repair the Glow Plug Relay 1 Control circuit for a short to ground. Perform ROAD TEST VERIFICATION - VER-2.	All
7	Turn the ignition off. Remove Glow Plug Relay 1 from the PDC. Disconnect the ECM harness connectors. Measure the resistance of the Glow Plug Relay 1 Control circuit. Is the resistance below 10.0 ohms?  Yes → Go To 8  No → Repair the Glow Plug Relay 1 Control circuit for an open. Perform ROAD TEST VERIFICATION - VER-2.	All
8	If there are no possible causes remaining, view repair.  Repair Replace and program the Engine Control Module in accordance with the Service Information. Perform ROAD TEST VERIFICATION - VER-2.	All

**Symptom List:**

- P0382-GLOW PLUG 2 CONTROL CIRCUIT - OPEN CIRCUIT**
- P0382-GLOW PLUG 2 CONTROL CIRCUIT - SHORT CIRCUIT**

**Test Note: All symptoms listed above are diagnosed using the same tests. The title for the tests will be P0382-GLOW PLUG 2 CONTROL CIRCUIT - OPEN CIRCUIT.**

**When Monitored and Set Condition:**

**P0382-GLOW PLUG 2 CONTROL CIRCUIT - OPEN CIRCUIT**

When Monitored: With the ignition on.

Set Condition: The ECM does not detect voltage on the Glow Plug Relay 2 Control circuit.

**P0382-GLOW PLUG 2 CONTROL CIRCUIT - SHORT CIRCUIT**

When Monitored: With the ignition off.

Set Condition: The ECM detects excessive current on the Glow Plug Relay 2 Control circuit.

**POSSIBLE CAUSES**

- INTERMITTENT CONDITION
- ASD RELAY OUTPUT CIRCUIT OPEN
- SUBSTITUTE GLOW PLUG RELAY 2
- GLOW PLUG RELAY 2 CONTROL CIRCUIT SHORTED TO VOLTAGE
- GLOW PLUG RELAY 2 CONTROL CIRCUIT SHORTED TO GROUND
- GLOW PLUG RELAY 2 CONTROL CIRCUIT OPEN
- ENGINE CONTROL MODULE

TEST	ACTION	APPLICABILITY
1	Turn the ignition on. With the DRB, actuate Glow Plug Relay 2. Is Glow Plug Relay 2 clicking?  Yes → Go To 2  No → Go To 3	All

**P0382-GLOW PLUG 2 CONTROL CIRCUIT - OPEN CIRCUIT — Continued**

TEST	ACTION	APPLICABILITY
2	<p><b>WARNING: WHEN THE ENGINE IS OPERATING, DO NOT STAND IN A DIRECT LINE WITH THE FAN. DO NOT PUT YOUR HANDS NEAR THE PULLEYS, BELTS OR FAN. DO NOT WEAR LOOSE CLOTHING.</b></p> <p><b>NOTE: The conditions that set the DTC are not present at this time. The following list may help in identifying the intermittent condition.</b></p> <p>With the engine running at normal operating temperature, monitor the DRB parameters related to the DTC while wiggling the wiring harness. Look for parameter values to change and/or a DTC to set.</p> <p>Review the DTC When Monitored and Set Conditions. If possible, try to duplicate the conditions under which the DTC was set.</p> <p>Refer to any Technical Service Bulletins (TSB) that may apply.</p> <p>Visually inspect the related wiring harness. Look for any chafed, pierced, pinched, or partially broken wires.</p> <p>Visually inspect the related wiring harness connectors. Look for broken, bent, pushed out, or corroded terminals.</p> <p>Were any of the above conditions present?</p> <p style="padding-left: 40px;">Yes → Repair as necessary. Perform ROAD TEST VERIFICATION - VER-2.</p> <p style="padding-left: 40px;">No → Test Complete.</p>	All
3	<p>Turn the ignition off.</p> <p>Remove Glow Plug Relay 2 from the PDC.</p> <p>Turn the ignition on.</p> <p>Using a 12-volt test light connected to ground, check the ASD Relay Output circuit.</p> <p>Does the test light illuminate brightly?</p> <p style="padding-left: 40px;">Yes → Go To 4</p> <p style="padding-left: 40px;">No → Repair the ASD Relay Output circuit for an open. Perform ROAD TEST VERIFICATION - VER-2.</p>	All
4	<p>Turn the ignition off.</p> <p>Install a substitute relay in place of Glow Plug Relay 2.</p> <p>Perform several ignition key cycles, pausing for at least 10 seconds between each cycle.</p> <p>Turn the ignition on.</p> <p>With the DRB, read ECM DTCs.</p> <p>Did this DTC reset?</p> <p style="padding-left: 40px;">Yes → Go To 5</p> <p style="padding-left: 40px;">No → Replace Glow Plug Relay 2. Perform ROAD TEST VERIFICATION - VER-2.</p>	All
5	<p>Turn the ignition off.</p> <p>Disconnect the ECM harness connectors.</p> <p>Remove Glow Plug Relay 2 from the PDC.</p> <p>Remove the ASD Relay from the PDC.</p> <p>Connect a jumper wire between cavity 30 and cavity 87 of the ASD Relay connector.</p> <p>Turn the ignition on.</p> <p>Measure the voltage on the Glow Plug Relay 2 Control circuit.</p> <p>Is the voltage above 1.0 volt?</p> <p style="padding-left: 40px;">Yes → Repair the Glow Plug Relay 2 Control circuit for a short to voltage. Perform ROAD TEST VERIFICATION - VER-2.</p> <p style="padding-left: 40px;">No → Go To 6</p>	All

**P0382-GLOW PLUG 2 CONTROL CIRCUIT - OPEN CIRCUIT — Continued**

TEST	ACTION	APPLICABILITY
6	Turn the ignition off. Remove Glow Plug Relay 2 from the PDC. Disconnect the ECM harness connectors. Measure the resistance between ground and the Glow Plug Relay 2 Control circuit. Is the resistance above 1000 ohms?  Yes → Go To 7  No → Repair the Glow Plug Relay 2 Control circuit for a short to ground. Perform ROAD TEST VERIFICATION - VER-2.	All
7	Turn the ignition off. Remove Glow Plug Relay 2 from the PDC. Disconnect the ECM harness connectors. Measure the resistance of the Glow Plug Relay 2 Control circuit. Is the resistance below 10.0 ohms?  Yes → Go To 8  No → Repair the Glow Plug Relay 2 Control circuit for an open. Perform ROAD TEST VERIFICATION - VER-2.	All
8	If there are no possible causes remaining, view repair.  Repair Replace and program the Engine Control Module in accordance with the Service Information. Perform ROAD TEST VERIFICATION - VER-2.	All

**Symptom:****P0403-EGR SOLENOID CIRCUIT NEGATIVE DEVIATION****When Monitored and Set Condition:****P0403-EGR SOLENOID CIRCUIT NEGATIVE DEVIATION**

When Monitored: With the engine running.

Set Condition: The ECM detects EGR flow is less than the requested flow.

**POSSIBLE CAUSES**

EGR VALVE  
 INTERMITTENT CONDITION  
 CHECKING VACUUM SUPPLY  
 EGR SOLENOID  
 ENGINE CONTROL MODULE - INTERNAL

TEST	ACTION	APPLICABILITY
1	Turn the ignition on. With the DRB, erase ECM DTCs. Test drive the vehicle and monitor the DRB for ECM DTCs. Did this DTC set again?  Yes → Go To 2  No → Go To 5	All
2	Turn the ignition off. Disconnect both vacuum lines at the EGR Solenoid. Using a vacuum line connection tee, connect the vacuum supply line to the EGR Solenoid Output line at the EGR Solenoid. Disconnect the vacuum line at the EGR Valve. Connect a vacuum gauge to the EGR Solenoid Output line at the EGR Valve. Start the engine. With the engine at idle, note the vacuum gauge reading. Is the vacuum above 22 inches?  Yes → Go To 3  No → Inspect the vacuum hoses/tubes for damage, restriction and leaks. If o.k. refer to the Service Information to check the Vacuum Pump operation. Perform ROAD TEST VERIFICATION - VER-2.	All

**P0403-EGR SOLENOID CIRCUIT NEGATIVE DEVIATION — Continued**

TEST	ACTION	APPLICABILITY
3	<p><b>NOTE: The engine must be at operating temperature for this test to be valid.</b>                      Turn the ignition off.                      Disconnect the vacuum line at the EGR Valve.                      Connect a vacuum gauge to the EGR Solenoid Output line at the EGR Valve                      Start the engine and observe the vacuum gauge reading for 1 minute.  <b>NOTE: The vacuum reading should increase to above 18 inches approximately 5 seconds after the engine is started. The vacuum should decrease to below 2 inches within 40 seconds of engine run time.</b>                      Did the vacuum reading increase to above 18 inches then decrease below 2 inches as described?</p> <p>Yes → Go To 4</p> <p>No → Replace the EGR Solenoid.                      Perform ROAD TEST VERIFICATION - VER-2.</p>	All
4	<p>Turn the ignition off.                      Disconnect both vacuum lines at the EGR Solenoid.                      Using a vacuum line connection tee, connect the vacuum supply line to the EGR Solenoid Output line at the EGR Solenoid.                      Test drive the vehicle and note the vehicles performance.  <b>NOTE: With the connection tee in place the EGR valve will receive full vacuum supply with the engine running. This should cause a severe reduction in engine power.</b>                      Does the vehicle exhibit a severe loss of power?</p> <p>Yes → Replace and program the Engine Control Module in accordance with the Service Information.                      Perform ROAD TEST VERIFICATION - VER-2.</p> <p>No → Replace the EGR Valve.                      Perform ROAD TEST VERIFICATION - VER-2.</p>	All
5	<p><b>WARNING: WHEN THE ENGINE IS OPERATING, DO NOT STAND IN A DIRECT LINE WITH THE FAN. DO NOT PUT YOUR HANDS NEAR THE PULLEYS, BELTS OR FAN. DO NOT WEAR LOOSE CLOTHING.</b>  <b>NOTE: The conditions that set the DTC are not present at this time. The following list may help in identifying the intermittent condition.</b>                      With the engine running at normal operating temperature, monitor the DRB parameters related to the DTC while wiggling the wiring harness. Look for parameter values to change and/or a DTC to set.                      Review the DTC When Monitored and Set Conditions. If possible, try to duplicate the conditions under which the DTC was set.                      Refer to any Technical Service Bulletins (TSB) that may apply.                      Visually inspect the related wiring harness. Look for any chafed, pierced, pinched, or partially broken wires.                      Visually inspect the related wiring harness connectors. Look for broken, bent, pushed out, or corroded terminals.                      Were any of the above conditions present?</p> <p>Yes → Repair as necessary.                      Perform ROAD TEST VERIFICATION - VER-2.</p> <p>No → Test Complete.</p>	All

**Symptom:****P0403-EGR SOLENOID CIRCUIT OPEN CIRCUIT****When Monitored and Set Condition:****P0403-EGR SOLENOID CIRCUIT OPEN CIRCUIT**

When Monitored: With the ignition on.

Set Condition: The ECM detects an open or short to ground on the EGR Solenoid Control circuit.

**POSSIBLE CAUSES**

INTERMITTENT CONDITION

ASD RELAY OUTPUT CIRCUIT OPEN

EGR SOLENOID CONTROL CIRCUIT SHORTED TO GROUND

EGR SOLENOID CONTROL CIRCUIT OPEN

SUBSTITUTE EGR SOLENOID

ENGINE CONTROL MODULE

TEST	ACTION	APPLICABILITY
1	Turn the ignition on. With the DRB, erase ECM DTCs. Perform several ignition cycles, turning the ignition off for at least 10 seconds between each ignition cycle. Monitor the DRB for ECM DTCs. Did this DTC set again?  Yes → Go To 2  No → Go To 7	All
2	Turn the ignition off. Disconnect the EGR Solenoid harness connector. Turn the ignition on. Using a 12-volt test light connected to ground, check the ASD Relay Output circuit. Does the test light illuminate brightly?  Yes → Go To 3  No → Repair the ASD Relay Output circuit for an open. Perform ROAD TEST VERIFICATION - VER-2.	All
3	Turn the ignition off. Disconnect the EGR Solenoid harness connector. Disconnect the ECM harness connectors. Measure the resistance between ground and the EGR Solenoid Control circuit. Is the resistance above 100 kohms?  Yes → Go To 4  No → Repair the EGR Solenoid Control circuit for a short to ground. Perform ROAD TEST VERIFICATION - VER-2.	All



**P0403-EGR SOLENOID CIRCUIT OPEN CIRCUIT — Continued**

TEST	ACTION	APPLICABILITY
4	Turn the ignition off. Disconnect the EGR Solenoid harness connector. Disconnect the ECM harness connectors. Measure the resistance of the EGR Solenoid Control circuit. Is the resistance below 5.0 ohms?  Yes → Go To 5  No → Repair the EGR Solenoid Control circuit for an open. Perform ROAD TEST VERIFICATION - VER-2.	All
5	Turn the ignition off. Install a substitute EGR Solenoid in place of the vehicle's EGR Solenoid. <b>NOTE: Ensure the ECM and EGR Solenoid harness connectors are connected.</b> Turn the ignition on. With the DRB, check for this DTC to set again. Did this DTC set again?  Yes → Go To 6  No → Replace the EGR Solenoid. Perform ROAD TEST VERIFICATION - VER-2.	All
6	If there are no possible causes remaining, view repair.  Repair Replace and program the Engine Control Module in accordance with the Service Information. Perform ROAD TEST VERIFICATION - VER-2.	All
7	<b>WARNING: WHEN THE ENGINE IS OPERATING, DO NOT STAND IN A DIRECT LINE WITH THE FAN. DO NOT PUT YOUR HANDS NEAR THE PULLEYS, BELTS OR FAN. DO NOT WEAR LOOSE CLOTHING.</b> <b>NOTE: The conditions that set the DTC are not present at this time. The following list may help in identifying the intermittent condition.</b> With the engine running at normal operating temperature, monitor the DRB parameters related to the DTC while wiggling the wiring harness. Look for parameter values to change and/or a DTC to set. Review the DTC When Monitored and Set Conditions. If possible, try to duplicate the conditions under which the DTC was set. Refer to any Technical Service Bulletins (TSB) that may apply. Visually inspect the related wiring harness. Look for any chafed, pierced, pinched, or partially broken wires. Visually inspect the related wiring harness connectors. Look for broken, bent, pushed out, or corroded terminals. Were any of the above conditions present?  Yes → Repair as necessary. Perform ROAD TEST VERIFICATION - VER-2.  No → Test Complete.	All

**Symptom:**

**P0403-EGR SOLENOID CIRCUIT SHORT CIRCUIT**

**When Monitored and Set Condition:**

**P0403-EGR SOLENOID CIRCUIT SHORT CIRCUIT**

When Monitored: With the ignition on.

Set Condition: The ECM detects excessive current draw on the EGR Solenoid Control circuit.

**POSSIBLE CAUSES**

INTERMITTENT CONDITION  
 EGR SOLENOID  
 EGR SOLENOID CONTROL SHORTED TO VOLTAGE  
 ENGINE CONTROL MODULE - INTERNAL  
 ENGINE CONTROL MODULE - INTERNAL SHORT TO VOLTAGE

TEST	ACTION	APPLICABILITY
1	Turn the ignition on. With the DRB, erase ECM DTCs. Test drive the vehicle and monitor the DRB for ECM DTCs. Did this DTC set again?  Yes → Go To 2 No → Go To 5	All
2	Turn the ignition off. Disconnect the EGR Solenoid harness connector. Turn the ignition on. With the DRB, erase ECM DTCs. Monitor the DRB for ECM DTCs. Does the DRB display P0403 EGR OPEN CIRCUIT?  Yes → Replace the EGR Solenoid. Perform ROAD TEST VERIFICATION - VER-2.  No → Go To 3	All
3	Turn the ignition off. Disconnect the EGR Solenoid harness connector. Turn the ignition on. Measure the voltage of the EGR Solenoid Control circuit at the EGR Solenoid harness connector. Is the voltage below 0.5 volt?  Yes → Replace and program the Engine Control Module in accordance with the Service Information. Perform ROAD TEST VERIFICATION - VER-2.  No → Go To 4	All

**P0403-EGR SOLENOID CIRCUIT SHORT CIRCUIT — Continued**

TEST	ACTION	APPLICABILITY
4	<p>Turn the ignition off.                      Disconnect the EGR Solenoid harness connector.                      Disconnect the ECM harness connectors.                      Remove the ASD Relay from the PDC.                      Connect a jumper wire between cavity 30 and cavity 87 of the ASD Relay connector.                      Turn the ignition on.                      Measure the voltage of the EGR Solenoid Control circuit.                      Is the voltage below 0.5 volt?</p> <p>Yes → Replace and program the Engine Control Module in accordance with the Service Information.                      Perform ROAD TEST VERIFICATION - VER-2.</p> <p>No → Repair the EGR Solenoid Control circuit for a short to voltage.                      Perform ROAD TEST VERIFICATION - VER-2.</p>	All
5	<p><b>WARNING: WHEN THE ENGINE IS OPERATING, DO NOT STAND IN A DIRECT LINE WITH THE FAN. DO NOT PUT YOUR HANDS NEAR THE PULLEYS, BELTS OR FAN. DO NOT WEAR LOOSE CLOTHING.</b></p> <p><b>NOTE: The conditions that set the DTC are not present at this time. The following list may help in identifying the intermittent condition.</b></p> <p>With the engine running at normal operating temperature, monitor the DRB parameters related to the DTC while wiggling the wiring harness. Look for parameter values to change and/or a DTC to set.                      Review the DTC When Monitored and Set Conditions. If possible, try to duplicate the conditions under which the DTC was set.                      Refer to any Technical Service Bulletins (TSB) that may apply.                      Visually inspect the related wiring harness. Look for any chafed, pierced, pinched, or partially broken wires.                      Visually inspect the related wiring harness connectors. Look for broken, bent, pushed out, or corroded terminals.                      Were any of the above conditions present?</p> <p>Yes → Repair as necessary.                      Perform ROAD TEST VERIFICATION - VER-2.</p> <p>No → Test Complete.</p>	All

**Symptom:**

**P0460-FUEL LEVEL SENSOR CIRCUIT SIGNAL VOLTAGE TOO HIGH**

**When Monitored and Set Condition:**

**P0460-FUEL LEVEL SENSOR CIRCUIT SIGNAL VOLTAGE TOO HIGH**

When Monitored: With the ignition on.

Set Condition: The Fuel Level Sensor Signal voltage is above 4.70 volts.

POSSIBLE CAUSES
INTERMITTENT CONDITION
FUEL LEVEL SENSOR SIGNAL CIRCUIT SHORTED TO VOLTAGE
FUEL LEVEL SENSOR SIGNAL CIRCUIT OPEN
FUEL LEVEL SENSOR GROUND CIRCUIT OPEN
FUEL LEVEL SENSOR
ENGINE CONTROL MODULE

TEST	ACTION	APPLICABILITY
1	Turn the ignition on. With the DRB, erase ECM DTCs. Turn the ignition off, wait 10 seconds, then turn the ignition on. With the DRB, read ECM DTCs. Did this DTC set again?  Yes → Go To 2  No → Go To 7	All
2	Turn the ignition off. Disconnect the ECM harness connectors. Disconnect the Fuel Level Sensor harness connector. Remove the ASD Relay from the PDC. Connect a jumper wire between cavity 30 and cavity 87 of the ASD Relay connector. Turn the ignition on. Measure the voltage on the Fuel Level Sensor Signal circuit. Is the voltage below 0.5 volt?  Yes → Go To 3  No → Repair the Fuel Level Sensor Signal circuit for a short to voltage. Perform ROAD TEST VERIFICATION - VER-2.	All

**P0460-FUEL LEVEL SENSOR CIRCUIT SIGNAL VOLTAGE TOO HIGH — Continued**

TEST	ACTION	APPLICABILITY
3	Turn the ignition off. Disconnect the ECM harness connectors. Disconnect the Fuel Level Sensor harness connector. Measure the resistance of the Fuel Level Sensor Signal circuit. Is the resistance below 5.0 ohms?  Yes → Go To 4  No → Repair the Fuel Level Sensor Signal circuit for an open. Perform ROAD TEST VERIFICATION - VER-2.	All
4	Turn the ignition off. Disconnect the ECM harness connectors. Disconnect the Fuel Level Sensor harness connector. Measure the resistance of the Fuel Level Sensor Ground circuit. Is the resistance below 5.0 ohms?  Yes → Go To 5  No → Repair the Fuel Level Sensor Ground circuit for an open. Perform ROAD TEST VERIFICATION - VER-2.	All
5	Turn the ignition off. Disconnect the Fuel Level Sensor harness connector. Turn the ignition on. With the DRB, read and record the Fuel Level Sensor voltage. <b>NOTE: The Fuel Level Sensor voltage should be 5.0 ± 0.3 volts with the sensor harness connector disconnected.</b> Connect a jumper wire between Fuel Level Sensor harness connector cavities 3 and 4. With the DRB, read the Fuel Level Sensor voltage. <b>NOTE: The Fuel Level Sensor voltage should be less than 1.0 volt with the jumper wire connected.</b> Are the voltage readings the expected voltages?  Yes → Replace the Fuel Level Sensor in accordance with the Service Information. Perform ROAD TEST VERIFICATION - VER-2.  No → Go To 6	All
6	If there are no possible causes remaining, view repair.  Repair Replace and program the Engine Control Module in accordance with the Service Information. Perform ROAD TEST VERIFICATION - VER-2.	All

## P0460-FUEL LEVEL SENSOR CIRCUIT SIGNAL VOLTAGE TOO HIGH — Continued

TEST	ACTION	APPLICABILITY
7	<p><b>WARNING: WHEN THE ENGINE IS OPERATING, DO NOT STAND IN A DIRECT LINE WITH THE FAN. DO NOT PUT YOUR HANDS NEAR THE PULLEYS, BELTS OR FAN. DO NOT WEAR LOOSE CLOTHING.</b></p> <p><b>NOTE: The conditions that set the DTC are not present at this time. The following list may help in identifying the intermittent condition.</b></p> <p>With the engine running at normal operating temperature, monitor the DRB parameters related to the DTC while wiggling the wiring harness. Look for parameter values to change and/or a DTC to set.</p> <p>Review the DTC When Monitored and Set Conditions. If possible, try to duplicate the conditions under which the DTC was set.</p> <p>Refer to any Technical Service Bulletins (TSB) that may apply.</p> <p>Visually inspect the related wiring harness. Look for any chafed, pierced, pinched, or partially broken wires.</p> <p>Visually inspect the related wiring harness connectors. Look for broken, bent, pushed out, or corroded terminals.</p> <p>Were any of the above conditions present?</p> <p>Yes → Repair as necessary. Perform ROAD TEST VERIFICATION - VER-2.</p> <p>No → Test Complete.</p>	All

**Symptom:**

**P0460-FUEL LEVEL SENSOR CIRCUIT SIGNAL VOLTAGE TOO LOW**

**When Monitored and Set Condition:**

**P0460-FUEL LEVEL SENSOR CIRCUIT SIGNAL VOLTAGE TOO LOW**

When Monitored: With the ignition on.

Set Condition: The Fuel Level Sensor Signal voltage is below 0.15 volt.

POSSIBLE CAUSES
INTERMITTENT CONDITION
FUEL LEVEL SENSOR
FUEL LEVEL SENSOR SIGNAL CIRCUIT SHORTED TO GROUND
FUEL LEVEL SENSOR SIGNAL AND GROUND CIRCUITS SHORTED TOGETHER
ENGINE CONTROL MODULE

TEST	ACTION	APPLICABILITY
1	Turn the ignition on. With the DRB, erase ECM DTCs. Turn the ignition off, wait 10 seconds, then turn the ignition on. With the DRB, read ECM DTCs. Did this DTC set again?  Yes → Go To 2  No → Go To 6	All
2	Turn the ignition off. Disconnect the Fuel Level Sensor harness connector. Turn the ignition on. With the DRB, read the Fuel Level Sensor voltage. Is the voltage above 4.8 volts?  Yes → Replace the Fuel Level Sensor in accordance with the Service Information. Perform ROAD TEST VERIFICATION - VER-2.  No → Go To 3	All
3	Turn the ignition off. Disconnect the ECM harness connectors. Disconnect the Fuel Level Sensor harness connector. Measure the resistance between ground and the Fuel Level Sensor Signal circuit. Is the resistance above 100 kohms?  Yes → Go To 4  No → Repair the Fuel Level Sensor Signal circuit for a short to ground. Perform ROAD TEST VERIFICATION - VER-2.	All

## P0460-FUEL LEVEL SENSOR CIRCUIT SIGNAL VOLTAGE TOO LOW — Continued

TEST	ACTION	APPLICABILITY
4	Turn the ignition off. Disconnect the ECM harness connectors. Disconnect the Fuel Level Sensor harness connector. Measure the resistance between the Fuel Level Sensor Signal circuit and Sensor Ground circuit. Is the resistance above 100 kohms?  Yes → Go To 5  No → Repair the Fuel Level Sensor Signal and Ground circuits for a short together. Perform ROAD TEST VERIFICATION - VER-2.	All
5	If there are no possible causes remaining, view repair.  Repair Replace and program the Engine Control Module in accordance with the Service Information. Perform ROAD TEST VERIFICATION - VER-2.	All
6	<b>WARNING: WHEN THE ENGINE IS OPERATING, DO NOT STAND IN A DIRECT LINE WITH THE FAN. DO NOT PUT YOUR HANDS NEAR THE PULLEYS, BELTS OR FAN. DO NOT WEAR LOOSE CLOTHING.</b> <b>NOTE: The conditions that set the DTC are not present at this time. The following list may help in identifying the intermittent condition.</b> With the engine running at normal operating temperature, monitor the DRB parameters related to the DTC while wiggling the wiring harness. Look for parameter values to change and/or a DTC to set. Review the DTC When Monitored and Set Conditions. If possible, try to duplicate the conditions under which the DTC was set. Refer to any Technical Service Bulletins (TSB) that may apply. Visually inspect the related wiring harness. Look for any chafed, pierced, pinched, or partially broken wires. Visually inspect the related wiring harness connectors. Look for broken, bent, pushed out, or corroded terminals. Were any of the above conditions present?  Yes → Repair as necessary. Perform ROAD TEST VERIFICATION - VER-2.  No → Test Complete.	All



**Symptom List:**

**P0500-VEHICLE SPEED SENSOR FREQUENCY TOO HIGH**  
**P0500-VEHICLE SPEED SENSOR HIGH LEVEL DURATION**  
**P0500-VEHICLE SPEED SENSOR PLAUSIBILITY**  
**P0500-VEHICLE SPEED SENSOR SIGNAL VOLTAGE TOO HIGH**

---

**Test Note: All symptoms listed above are diagnosed using the same tests. The title for the tests will be P0500-VEHICLE SPEED SENSOR FREQUENCY TOO HIGH.**

---

**When Monitored and Set Condition:**

**P0500-VEHICLE SPEED SENSOR FREQUENCY TOO HIGH**

When Monitored: With the engine running.

Set Condition: The ECM detects a vehicle speed greater than the vehicle is capable.

**P0500-VEHICLE SPEED SENSOR PLAUSIBILITY**

When Monitored: With the engine under load and engine speed greater than 2400 RPM while vehicle speed is below 20 km/h (12 MPH).

Set Condition: The ECM compares the amount of fuel the fuel injectors are delivering to the vehicle speed from the VSS. The VSS indicates a vehicle speed that cannot be achieved with the present amount of fuel being delivered.

**P0500-VEHICLE SPEED SENSOR SIGNAL VOLTAGE TOO HIGH**

When Monitored: With the engine running.

Set Condition: The ECM detects a vehicle speed greater than 220 km/h (137 MPH).

---

**POSSIBLE CAUSES**

INTERMITTENT CONDITION  
CHECK FOR RELATED CONTROLLER ANTILOCK BRAKES DTCS  
CONTROLLER ANTILOCK BRAKE MODULE  
VEHICLE SPEED SIGNAL CIRCUIT SHORTED TO GROUND  
VEHICLE SPEED SIGNAL CIRCUIT SHORTED TO VOLTAGE  
VEHICLE SPEED SIGNAL CIRCUIT OPEN  
ENGINE CONTROL MODULE - NO VOLTAGE  
ENGINE CONTROL MODULE - NO VOLTAGE CHANGE  
ENGINE CONTROL MODULE - VOLTAGE TOO HIGH

**P0500-VEHICLE SPEED SENSOR FREQUENCY TOO HIGH — Continued**

TEST	ACTION	APPLICABILITY
1	Turn the ignition on. With the DRB, erase ECM DTCs. Test drive the vehicle. With the DRB, read Vehicle Speed. Does the DRB display an accurate Vehicle Speed?  Yes → Go To 2  No → Go To 3	All
2	<b>WARNING: WHEN THE ENGINE IS OPERATING, DO NOT STAND IN A DIRECT LINE WITH THE FAN. DO NOT PUT YOUR HANDS NEAR THE PULLEYS, BELTS OR FAN. DO NOT WEAR LOOSE CLOTHING.</b> <b>NOTE: The conditions that set the DTC are not present at this time. The following list may help in identifying the intermittent condition.</b> With the engine running at normal operating temperature, monitor the DRB parameters related to the DTC while wiggling the wiring harness. Look for parameter values to change and/or a DTC to set. Review the DTC When Monitored and Set Conditions. If possible, try to duplicate the conditions under which the DTC was set. Refer to any Technical Service Bulletins (TSB) that may apply. Visually inspect the related wiring harness. Look for any chafed, pierced, pinched, or partially broken wires. Visually inspect the related wiring harness connectors. Look for broken, bent, pushed out, or corroded terminals. Were any of the above conditions present?  Yes → Repair as necessary. Perform ROAD TEST VERIFICATION - VER-2.  No → Test Complete.	All
3	Turn the ignition on. With the DRB, check for Controller Antilock Brakes DTCs. Are any related CAB DTCs present?  Yes → Refer to symptom list for problems related to CAB DTCs before continuing. Perform ROAD TEST VERIFICATION - VER-2.  No → Go To 4	All
4	Turn the ignition off. Disconnect the CAB harness connectors. Turn the ignition on. Measure the voltage of the Vehicle Speed Signal circuit. Select the range that the voltage reading falls into.  Above 5.4 volts Go To 5  Between 4.5 and 5.4 volts Go To 6  Below 4.5 volts Go To 7	All

**P0500-VEHICLE SPEED SENSOR FREQUENCY TOO HIGH — Continued**

TEST	ACTION	APPLICABILITY
5	<p>Turn the ignition off.                      Disconnect the CAB harness connectors.                      Disconnect the ECM harness connectors.                      Remove the ASD Relay from the PDC.                      Connect a jumper wire between cavity 30 and cavity 87 of the ASD Relay connector.                      Turn the ignition on.                      Measure the voltage on the Vehicle Speed Signal circuit.                      Is the voltage above 1.0 volt?</p> <p>Yes → Repair the Vehicle Speed Signal circuit for a short to voltage.                      Perform ROAD TEST VERIFICATION - VER-2.</p> <p>No → Replace and program the Engine Control Module in accordance with the Service Information.                      Perform ROAD TEST VERIFICATION - VER-2.</p>	All
6	<p>Turn the ignition off.                      Disconnect the CAB harness connectors.                      Turn the ignition on.                      Connect one end of a jumper wire to the Vehicle Speed Signal circuit.                      With the DRB, select, isolate and observe the Vehicle Speed status while tapping the other end of the jumper wire to ground.                      Does the DRB display a vehicle speed change while tapping the jumper wire to ground?</p> <p>Yes → Replace the Controller Antilock Brake Module in accordance with the Service Information.                      Perform ROAD TEST VERIFICATION - VER-2.</p> <p>No → Replace and program the Engine Control Module in accordance with the Service Information.                      Perform ROAD TEST VERIFICATION - VER-2.</p>	All
7	<p>Turn the ignition off.                      Disconnect the CAB harness connectors.                      Disconnect the ECM harness connectors.                      Measure the resistance between ground and the Vehicle Speed Signal circuit.                      Is the resistance above 100 kohms?</p> <p>Yes → Go To 8</p> <p>No → Repair the Vehicle Speed Signal circuit for a short to ground.                      Perform ROAD TEST VERIFICATION - VER-2.</p>	All
8	<p>Turn the ignition off.                      Disconnect the CAB harness connectors.                      Disconnect the ECM harness connectors.                      Measure the resistance of the Vehicle Speed Signal circuit.                      Is the resistance below 5.0 ohms?</p> <p>Yes → Go To 9</p> <p>No → Repair the Vehicle Speed Signal circuit for an open.                      Perform ROAD TEST VERIFICATION - VER-2.</p>	All
9	<p>If there are no possible causes remaining, view repair.</p> <p>Repair</p> <p>Replace and program the Engine Control Module in accordance with the Service Information.                      Perform ROAD TEST VERIFICATION - VER-2.</p>	All

**Symptom:**

**P0514-BATTERY TEMP SENSOR CIRCUIT SIGNAL VOLTAGE TOO HIGH**

**When Monitored and Set Condition:**

**P0514-BATTERY TEMP SENSOR CIRCUIT SIGNAL VOLTAGE TOO HIGH**

When Monitored: With the ignition on.

Set Condition: The ECM detects Battery Temperature Sensor Signal voltage above 4.9 volts.

POSSIBLE CAUSES
INTERMITTENT CONDITION
BATTERY TEMPERATURE SENSOR GROUND CIRCUIT OPEN
BATTERY TEMPERATURE SENSOR SIGNAL CIRCUIT SHORTED TO VOLTAGE
BATTERY TEMPERATURE SENSOR
BATTERY TEMPERATURE SENSOR SIGNAL CIRCUIT OPEN
ENGINE CONTROL MODULE

TEST	ACTION	APPLICABILITY
1	Turn the ignition on. With the DRB, monitor the Battery Temperature Sensor voltage. Is the voltage above 4.5 volts?  Yes → Go To 2  No → Go To 6	All
2	Turn the ignition off. Disconnect the Battery Temperature Sensor harness connector. Turn the ignition on. Measure the voltage on the Battery Temperature Sensor Signal circuit. Is the voltage above 5.5 volts?  Yes → Repair the Battery Temperature Sensor Signal circuit for a short to voltage. Perform ROAD TEST VERIFICATION - VER-2.  No → Go To 3	All

**P0514-BATTERY TEMP SENSOR CIRCUIT SIGNAL VOLTAGE TOO HIGH**

— Continued

TEST	ACTION	APPLICABILITY
3	<p>Turn the ignition off.                      Disconnect the Battery Temperature Sensor harness connector.                      Connect a jumper wire between the Battery Temperature Sensor harness connector cavities.                      Turn the ignition on.                      With the DRB, read the Battery Temperature Sensor voltage.                      Is the voltage below 1.0 volt?</p> <p>Yes → Replace the Battery Temperature Sensor in accordance with the Service Information.                      Perform ROAD TEST VERIFICATION - VER-2.</p> <p>No → Go To 4</p>	All
4	<p>Turn the ignition off.                      Disconnect the Battery Temperature Sensor harness connector.                      Connect a jumper wire between ground and the Battery Temperature Sensor Signal circuit.                      Turn the ignition on.                      With the DRB, read the Battery Temperature Sensor voltage.                      Is the voltage below 1.0 volt?</p> <p>Yes → Repair the Sensor Ground circuit for an open.                      Perform ROAD TEST VERIFICATION - VER-2.</p> <p>No → Go To 5</p>	All
5	<p>Turn the ignition off.                      Disconnect the ECM harness connectors.                      Disconnect the Battery Temperature Sensor harness connector.                      Measure the resistance of the Battery Temperature Sensor Signal circuit.                      Is the resistance below 5.0 ohms?</p> <p>Yes → Replace and program the Engine Control Module in accordance with the Service Information.                      Perform ROAD TEST VERIFICATION - VER-2.</p> <p>No → Repair the Battery Temperature Sensor Signal circuit for an open.                      Perform ROAD TEST VERIFICATION - VER-2.</p>	All
6	<p><b>WARNING: WHEN THE ENGINE IS OPERATING, DO NOT STAND IN A DIRECT LINE WITH THE FAN. DO NOT PUT YOUR HANDS NEAR THE PULLEYS, BELTS OR FAN. DO NOT WEAR LOOSE CLOTHING.</b></p> <p><b>NOTE: The conditions that set the DTC are not present at this time. The following list may help in identifying the intermittent condition.</b></p> <p>With the engine running at normal operating temperature, monitor the DRB parameters related to the DTC while wiggling the wiring harness. Look for parameter values to change and/or a DTC to set.                      Review the DTC When Monitored and Set Conditions. If possible, try to duplicate the conditions under which the DTC was set.                      Refer to any Technical Service Bulletins (TSB) that may apply.                      Visually inspect the related wiring harness. Look for any chafed, pierced, pinched, or partially broken wires.                      Visually inspect the related wiring harness connectors. Look for broken, bent, pushed out, or corroded terminals.                      Were any of the above conditions present?</p> <p>Yes → Repair as necessary.                      Perform ROAD TEST VERIFICATION - VER-2.</p> <p>No → Test Complete.</p>	All

**Symptom:**

**P0514-BATTERY TEMP SENSOR CIRCUIT SIGNAL VOLTAGE TOO LOW**

**When Monitored and Set Condition:**

**P0514-BATTERY TEMP SENSOR CIRCUIT SIGNAL VOLTAGE TOO LOW**

When Monitored: With the ignition on.

Set Condition: The ECM detects Battery Temperature Sensor Signal voltage below 0.151 volt.

POSSIBLE CAUSES
INTERMITTENT CONDITION BATTERY TEMPERATURE SENSOR BATTERY TEMPERATURE SENSOR SIGNAL CIRCUIT SHORTED TO GROUND BATTERY TEMPERATURE SENSOR SIGNAL AND GROUND CIRCUITS SHORTED TOGETHER ENGINE CONTROL MODULE

TEST	ACTION	APPLICABILITY
1	Turn the ignition on. With the DRB, monitor the Battery Temperature Sensor voltage. Is the Battery Temperature Sensor voltage below 0.151 volt?  Yes → Go To 2 No → Go To 5	All
2	Turn the ignition off. Disconnect the Battery Temperature Sensor harness connector. Turn the ignition on. With the DRB, read the Battery Temperature Sensor voltage. Is the voltage above 4.0 volts?  Yes → Replace the Battery Temperature Sensor in accordance with the Service Information. Perform ROAD TEST VERIFICATION - VER-2.  No → Go To 3	All
3	Turn the ignition off. Disconnect the ECM harness connectors. Disconnect the Battery Temperature Sensor harness connector. Measure the resistance between ground and the Battery Temperature Sensor Signal circuit. Is the resistance above 1000 ohms?  Yes → Go To 4  No → Repair the Battery Temperature Sensor Signal circuit for a short to ground. Perform ROAD TEST VERIFICATION - VER-2.	All

**P0514-BATTERY TEMP SENSOR CIRCUIT SIGNAL VOLTAGE TOO LOW**  
 — Continued

TEST	ACTION	APPLICABILITY
4	Turn the ignition off. Disconnect the ECM harness connectors. Disconnect the Battery Temperature Sensor harness connector. Measure the resistance between the Battery Temperature Sensor Signal circuit and Sensor Ground circuit. Is the resistance above 1000 ohms?  Yes → Replace and program the Engine Control Module in accordance with the Service Information. Perform ROAD TEST VERIFICATION - VER-2.  No → Repair the Battery Temperature Sensor Signal and Ground circuits for a short together. Perform ROAD TEST VERIFICATION - VER-2.	All
5	<p><b>WARNING: WHEN THE ENGINE IS OPERATING, DO NOT STAND IN A DIRECT LINE WITH THE FAN. DO NOT PUT YOUR HANDS NEAR THE PULLEYS, BELTS OR FAN. DO NOT WEAR LOOSE CLOTHING.</b></p> <p><b>NOTE: The conditions that set the DTC are not present at this time. The following list may help in identifying the intermittent condition.</b></p> With the engine running at normal operating temperature, monitor the DRB parameters related to the DTC while wiggling the wiring harness. Look for parameter values to change and/or a DTC to set. Review the DTC When Monitored and Set Conditions. If possible, try to duplicate the conditions under which the DTC was set. Refer to any Technical Service Bulletins (TSB) that may apply. Visually inspect the related wiring harness. Look for any chafed, pierced, pinched, or partially broken wires. Visually inspect the related wiring harness connectors. Look for broken, bent, pushed out, or corroded terminals. Were any of the above conditions present?  Yes → Repair as necessary. Perform ROAD TEST VERIFICATION - VER-2.  No → Test Complete.	All

**Symptom:**

**P0520-OIL PRESS SENSOR CKT MALF SIGNAL VOLTAGE TOO HIGH**

**When Monitored and Set Condition:**

**P0520-OIL PRESS SENSOR CKT MALF SIGNAL VOLTAGE TOO HIGH**

When Monitored: With the engine running.

Set Condition: The ECM detects the Oil Pressure Sensor Signal above 4.9 volts for more than 3 seconds.

**POSSIBLE CAUSES**

ECM - OIL PRESSURE SENSOR SIGNAL CIRCUIT SHORTED TO VOLTAGE  
 ECM - OIL PRESSURE SENSOR SIGNAL OPEN  
 ENGINE OIL PRESSURE SENSOR  
 OIL PRESSURE SENSOR SIGNAL CIRCUIT OPEN  
 OIL PRESSURE SENSOR SIGNAL CIRCUIT SHORTED TO VOLTAGE  
 SENSOR GROUND CIRCUIT OPEN  
 INTERMITTENT CONDITION

TEST	ACTION	APPLICABILITY
1	<p><b>NOTE: If DTC P0641 or P0651 is present with this DTC, diagnose DTCs P0641 and P0651 before diagnosing this DTC.</b></p> <p>Turn the ignition on.                      With the DRBIII®, erase ECM DTCs.                      Start the engine several times, letting the engine run for at least 30 seconds at a time.                      With the DRBIII®, read ECM DTCs.                      Did this DTC set again?</p> <p>Yes → Go To 2                      No → Go To 6</p>	All
2	<p>Turn the ignition off.                      Disconnect the Oil Pressure Sensor harness connector.                      Turn the ignition on.                      Measure the voltage of the Oil Pressure Sensor Signal circuit.                      Select the appropriate voltage reading.</p> <p>Voltage is above 5.5 volts.                      Go To 3</p> <p>Voltage is between 4.7 and 5.4 volts.                      Go To 4</p> <p>Voltage is below 4.7 volts.                      Go To 5</p>	All



**P0520-OIL PRESS SENSOR CKT MALF SIGNAL VOLTAGE TOO HIGH —  
Continued**

TEST	ACTION	APPLICABILITY
3	Turn the ignition off. Disconnect the Oil Pressure Sensor harness connector. Disconnect the ECM harness connectors. Remove the ASD Relay from the PDC. Connect a jumper wire between cavity 30 and cavity 87 of the ASD Relay connector. Turn the ignition on. Measure the voltage of the Oil Pressure Sensor Signal circuit. Is the voltage below 1.0 volt?  Yes → Replace and program the Engine Control Module in accordance with the Service Information. Perform ROAD TEST VERIFICATION - VER-2.  No → Repair the Oil Pressure Sensor Signal circuit for a short to voltage. Perform ROAD TEST VERIFICATION - VER-2.	All
4	Turn the ignition off. Disconnect the ECM harness connectors. Disconnect the Oil Pressure Sensor harness connector. Measure the resistance of the Sensor Ground circuit. Is the resistance below 5.0 ohms?  Yes → Replace the Engine Oil Pressure Sensor. Perform ROAD TEST VERIFICATION - VER-2.  No → Repair the Sensor Ground circuit for an open. Perform ROAD TEST VERIFICATION - VER-2.	All
5	Turn the ignition off. Disconnect the ECM harness connectors. Disconnect the Oil Pressure Sensor harness connector. Measure the resistance of the Oil Pressure Sensor Signal circuit. Is the resistance below 5.0 ohms?  Yes → Replace and program the Engine Control Module in accordance with the Service Information. Perform ROAD TEST VERIFICATION - VER-2.  No → Repair the Oil Pressure Sensor Signal circuit for an open. Perform ROAD TEST VERIFICATION - VER-2.	All

## P0520-OIL PRESS SENSOR CKT MALF SIGNAL VOLTAGE TOO HIGH — Continued

TEST	ACTION	APPLICABILITY
6	<p><b>WARNING: WHEN THE ENGINE IS OPERATING, DO NOT STAND IN A DIRECT LINE WITH THE FAN. DO NOT PUT YOUR HANDS NEAR THE PULLEYS, BELTS OR FAN. DO NOT WEAR LOOSE CLOTHING.</b></p> <p><b>NOTE: The conditions that set the DTC are not present at this time. The following list may help in identifying the intermittent condition.</b></p> <p>With the engine running and at normal operating temperature, monitor the DRB parameters related to the DTC while wiggling the wiring harness. Look for parameter values to change and/or a DTC to set.</p> <p>Review the DTC When Monitored and Set Conditions. If possible, try to duplicate the conditions under which the DTC was set.</p> <p>Refer to any Technical Service Bulletins (TSB) that may apply.</p> <p>Visually inspect the related wiring harness. Look for any chafed, pierced, pinched, or partially broken wires.</p> <p>Visually inspect the related wiring harness connectors. Look for broken, bent, pushed out, or corroded terminals.</p> <p>Were any of the above conditions present?</p> <p style="padding-left: 40px;">Yes → Repair as necessary. Perform ROAD TEST VERIFICATION - VER-2.</p> <p style="padding-left: 40px;">No → Test Complete.</p>	All

**Symptom:**

**P0520-OIL PRESS SENSOR CKT MALF SIGNAL VOLTAGE TOO LOW**

**When Monitored and Set Condition:**

**P0520-OIL PRESS SENSOR CKT MALF SIGNAL VOLTAGE TOO LOW**

When Monitored: With the engine running.

Set Condition: The ECM detects the Oil Pressure Sensor Signal voltage below 0.1 volt for more than 3 seconds.

POSSIBLE CAUSES
CHECK THE OIL PRESSURE SENSOR ECM - OIL PRESSURE SENSOR SIGNAL SHORT TO GROUND OIL PRESSURE SENSOR SIGNAL CIRCUIT SHORTED TO GROUND OIL PRESSURE SENSOR SIGNAL CIRCUIT SHORTED TO SENSOR GROUND INTERMITTENT CONDITION

TEST	ACTION	APPLICABILITY
1	Turn the ignition on. With the DRBIII®, erase ECM DTCs. Cycle the ignition key on and off several times, leaving the key on for at least 10 seconds at a time. With the DRBIII®, read ECM DTCs. Did this DTC set again?  Yes → Go To 2  No → Go To 5	All
2	Turn the ignition off. Disconnect the Oil Pressure Sensor harness connector. Measure the voltage of the Oil Pressure Sensor Signal circuit. Is the voltage between 4.7 and 5.3 volts?  Yes → Replace the Engine Oil Pressure Sensor. Perform ROAD TEST VERIFICATION - VER-2.  No → Go To 3	All
3	Turn the ignition off. Disconnect the ECM harness connectors. Disconnect the Oil Pressure Sensor harness connector. Measure the resistance between ground and the Oil Pressure Sensor Signal circuit. Is the resistance above 100 kohms?  Yes → Go To 4  No → Repair the Oil Pressure Sensor Signal circuit for a short to ground. Perform ROAD TEST VERIFICATION - VER-2.	All

## P0520-OIL PRESS SENSOR CKT MALF SIGNAL VOLTAGE TOO LOW — Continued

TEST	ACTION	APPLICABILITY
4	<p>Turn the ignition off.            Disconnect the ECM harness connectors.            Disconnect the Oil Pressure Sensor harness connector.            Measure the resistance between Sensor Ground and the Oil Pressure Sensor Signal circuit.            Is the resistance above 100 kohms?</p> <p>Yes → Replace and program the Engine Control Module in accordance with the Service Information.            Perform ROAD TEST VERIFICATION - VER-2.</p> <p>No → Repair the Oil Pressure Sensor Signal circuit for a short to Sensor Ground.            Perform ROAD TEST VERIFICATION - VER-2.</p>	All
5	<p><b>WARNING: WHEN THE ENGINE IS OPERATING, DO NOT STAND IN A DIRECT LINE WITH THE FAN. DO NOT PUT YOUR HANDS NEAR THE PULLEYS, BELTS OR FAN. DO NOT WEAR LOOSE CLOTHING.</b></p> <p><b>NOTE: The conditions that set the DTC are not present at this time. The following list may help in identifying the intermittent condition.</b></p> <p>With the engine running and at normal operating temperature, monitor the DRB parameters related to the DTC while wiggling the wiring harness. Look for parameter values to change and/or a DTC to set.</p> <p>Review the DTC When Monitored and Set Conditions. If possible, try to duplicate the conditions under which the DTC was set.</p> <p>Refer to any Technical Service Bulletins (TSB) that may apply.</p> <p>Visually inspect the related wiring harness. Look for any chafed, pierced, pinched, or partially broken wires.</p> <p>Visually inspect the related wiring harness connectors. Look for broken, bent, pushed out, or corroded terminals.</p> <p>Were any of the above conditions present?</p> <p>Yes → Repair as necessary.            Perform ROAD TEST VERIFICATION - VER-2.</p> <p>No → Test Complete.</p>	All

**Symptom:**

**P0520-OIL PRESS SENSOR CKT MALF SUPPLY VOLTAGE TOO HIGH OR LOW**

**When Monitored and Set Condition:**

**P0520-OIL PRESS SENSOR CKT MALF SUPPLY VOLTAGE TOO HIGH OR LOW**

When Monitored: With the ignition on.

Set Condition: The Sensor Reference Voltage A voltage to the Oil Pressure Sensor is below 4.8 volts or above 5.2 volts for at least 100 ms.

POSSIBLE CAUSES
INTERMITTENT CONDITION
5-VOLT SUPPLY CIRCUIT SHORTED TO GROUND
5-VOLT SUPPLY CIRCUIT SHORTED TO SENSOR GROUND
5-VOLT SUPPLY CIRCUIT SHORTED TO VOLTAGE
ENGINE CONTROL MODULE

TEST	ACTION	APPLICABILITY
1	<p><b>NOTE: If DTC P0641 or P0651 is present with this DTC, diagnose DTCs P0641 and P0651 before diagnosing this DTC.</b></p> <p>Turn the ignition on.                      With the DRB, erase ECM DTCs.                      Turn the ignition off, wait 30 seconds, then start and idle the engine.                      With the DRB, read ECM DTCs.                      Did this DTC set again?</p> <p style="padding-left: 40px;">Yes → Go To 2</p> <p style="padding-left: 40px;">No → Go To 5</p>	All
2	<p>Turn the ignition off.                      Disconnect the Oil Pressure Sensor harness connector.                      Disconnect the ECM harness connectors.                      Remove the ASD Relay from the PDC.                      Connect a jumper wire between cavity 30 and cavity 87 of the ASD Relay connector.                      Turn the ignition on.                      Measure the voltage between ground and the 5-volt Supply circuit at the Oil Pressure Sensor harness connector.                      Is the voltage above 1.0 volt?</p> <p style="padding-left: 40px;">Yes → Repair the 5-volt Supply circuit for a short to voltage.                      Perform ROAD TEST VERIFICATION - VER-2.</p> <p style="padding-left: 40px;">No → Go To 3</p>	All

**P0520-OIL PRESS SENSOR CKT MALF SUPPLY VOLTAGE TOO HIGH OR LOW — Continued**

TEST	ACTION	APPLICABILITY
3	Turn the ignition off. Disconnect the ECM harness connectors. Disconnect the Oil Pressure Sensor harness connector. Measure the resistance between ground and the 5-volt Supply circuit at the Oil Pressure Sensor harness connector. Is the resistance above 1000 ohms?  Yes → Go To 4  No → Repair the 5-volt Supply circuit for a short to ground. Perform ROAD TEST VERIFICATION - VER-2.	All
4	Turn the ignition off. Disconnect the ECM harness connectors. Disconnect the Oil Pressure Sensor harness connector. Measure the resistance between Sensor Ground and the 5-volt Supply circuit at the Oil Pressure Sensor harness connector. Is the resistance above 1000 ohms?  Yes → Replace and program the Engine Control Module in accordance with the Service Information. Perform ROAD TEST VERIFICATION - VER-2.  No → Repair the 5-volt Supply circuit for a short to Sensor Ground. Perform ROAD TEST VERIFICATION - VER-2.	All
5	<b>WARNING: WHEN THE ENGINE IS OPERATING, DO NOT STAND IN A DIRECT LINE WITH THE FAN. DO NOT PUT YOUR HANDS NEAR THE PULLEYS, BELTS OR FAN. DO NOT WEAR LOOSE CLOTHING.</b> <b>NOTE: The conditions that set the DTC are not present at this time. The following list may help in identifying the intermittent condition.</b> With the engine running at normal operating temperature, monitor the DRB parameters related to the DTC while wiggling the wiring harness. Look for parameter values to change and/or a DTC to set. Review the DTC When Monitored and Set Conditions. If possible, try to duplicate the conditions under which the DTC was set. Refer to any Technical Service Bulletins (TSB) that may apply. Visually inspect the related wiring harness. Look for any chafed, pierced, pinched, or partially broken wires. Visually inspect the related wiring harness connectors. Look for broken, bent, pushed out, or corroded terminals. Were any of the above conditions present?  Yes → Repair as necessary. Perform ROAD TEST VERIFICATION - VER-2.  No → Test Complete.	All

**Symptom List:**

**P0530-A/C PRESSURE SENSOR CIRCUIT SIGNAL VOLTAGE TOO HIGH**

**P0530-A/C PRESSURE SENSOR CIRCUIT SIGNAL VOLTAGE TOO LOW**

**P0530-A/C PRESSURE SENSOR CIRCUIT SUPPLY VOLTAGE TOO HIGH OR LOW**

---

**Test Note: All symptoms listed above are diagnosed using the same tests. The title for the tests will be P0530-A/C PRESSURE SENSOR CIRCUIT SIGNAL VOLTAGE TOO HIGH.**

---

**When Monitored and Set Condition:**

**P0530-A/C PRESSURE SENSOR CIRCUIT SIGNAL VOLTAGE TOO HIGH**

When Monitored: With the ignition on.

Set Condition: The A/C Pressure Sensor Signal voltage is above 4.84 volts.

**P0530-A/C PRESSURE SENSOR CIRCUIT SIGNAL VOLTAGE TOO LOW**

When Monitored: With the ignition on.

Set Condition: The A/C Pressure Sensor Signal voltage is below 0.15 volt.

**P0530-A/C PRESSURE SENSOR CIRCUIT SUPPLY VOLTAGE TOO HIGH OR LOW**

When Monitored: With the ignition on.

Set Condition: The Sensor Reference Voltage B voltage to the A/C Pressure Sensor is below 4.9 volts or above 5.1 volts for at least 100 ms.

---

**POSSIBLE CAUSES**

INTERMITTENT CONDITION

A/C PRESSURE SENSOR SIGNAL CIRCUIT SHORTED TO 5 VOLT SUPPLY CIRCUIT

A/C PRESSURE SENSOR SIGNAL CIRCUIT SHORTED TO VOLTAGE

A/C PRESSURE SENSOR GROUND CIRCUIT SHORTED TO VOLTAGE

A/C PRESSURE SENSOR

SENSOR REFERENCE VOLTAGE B CIRCUIT OPEN

A/C PRESSURE SENSOR SIGNAL CIRCUIT OPEN

SENSOR GROUND CIRCUIT OPEN

A/C PRESSURE SENSOR

A/C PRESSURE SENSOR SIGNAL CIRCUIT SHORTED TO GROUND

A/C PRESSURE SENSOR SIGNAL CIRCUIT SHORTED TO SENSOR GROUND CIRCUIT

**P0530-A/C PRESSURE SENSOR CIRCUIT SIGNAL VOLTAGE TOO HIGH**

— Continued

**POSSIBLE CAUSES**

ECM - A/C PRESSURE SENSOR SIGNAL  
 ECM - SENSOR REFERENCE VOLTAGE B CIRCUIT  
 ECM - SIGNAL VOLTAGE HIGH

TEST	ACTION	APPLICABILITY
1	<p><b>NOTE: If DTC P0641 or P0651 is present with this DTC, diagnose DTCs P0641 and P0651 before diagnosing this DTC.</b>  <b>NOTE: Ensure the A/C refrigerant System is properly charged per the Service Information.</b></p> <p>Start the engine.            With the DRBIII®, read the A/C Pressure Sensor voltage.            Select the choice that best reflects the DRBIII® reading.</p> <p style="padding-left: 40px;">Above 4.6 volts Go To 2</p> <p style="padding-left: 40px;">Between 0.7 and 4.6 volts Go To 9</p> <p style="padding-left: 40px;">Below 0.7 volt Go To 10</p>	All
2	<p>Turn the ignition off.            Disconnect the A/C Pressure Sensor harness connector.            Disconnect the ECM harness connector.            Measure the resistance between the A/C Pressure Sensor Signal circuit and the 5-volt Supply circuit in the A/C Pressure Sensor harness connector.            Is the resistance above 100 kohms?</p> <p style="padding-left: 40px;">Yes → Go To 3</p> <p style="padding-left: 40px;">No → Repair the A/C Pressure Sensor Signal circuit for a short to the 5-volt Supply circuit. Perform ROAD TEST VERIFICATION - VER-2.</p>	All
3	<p>Turn the ignition off.            Disconnect the A/C Pressure Sensor harness connector.            Disconnect the ECM harness connectors.            Remove the ASD Relay from the PDC.            Connect a jumper wire between cavity 30 and cavity 87 of the ASD Relay connector.            Turn the ignition on.            Measure the voltage of the Sensor Ground circuit at the A/C Pressure Sensor and ECM harness connectors.            Is the voltage above 1.0 volt at either connector?</p> <p style="padding-left: 40px;">Yes → Repair the A/C Pressure Sensor Ground circuit for a short to voltage. Perform ROAD TEST VERIFICATION - VER-2.</p> <p style="padding-left: 40px;">No → Go To 4</p> <p><b>NOTE: If the Sensor Ground circuit had a short to voltage on it, the ECM may have been damaged. Retest the A/C Pressure Sensor circuit.</b></p>	All



**P0530-A/C PRESSURE SENSOR CIRCUIT SIGNAL VOLTAGE TOO HIGH**

— Continued

TEST	ACTION	APPLICABILITY
4	Turn the ignition off. Disconnect the A/C Pressure Sensor harness connector. Turn the ignition on. Measure the voltage of the A/C Pressure Sensor Signal circuit in the A/C Pressure Sensor harness connector. Is the voltage above 5.5 volts?  Yes → Repair the A/C Pressure Sensor Signal circuit for a short to voltage. Perform ROAD TEST VERIFICATION - VER-2.  No → Go To 5	All
5	Turn the ignition off. Disconnect the A/C Pressure Sensor harness connector. Connect a jumper wire between the A/C Pressure Sensor Signal circuit and the Sensor Ground circuit. With the DRBIII®, monitor the A/C Pressure Sensor voltage. Turn the ignition on. Is the voltage below 1.0 volt?  Yes → Replace the A/C Pressure Sensor. Perform ROAD TEST VERIFICATION - VER-2.  No → Go To 6	All
6	Turn the ignition off. Disconnect the A/C Pressure Sensor harness connector. Disconnect the ECM harness connector. Measure the resistance of the A/C Pressure Sensor Signal circuit. Is the resistance below 5 ohms?  Yes → Go To 7  No → Repair the A/C Pressure Sensor Signal circuit for an open. Perform ROAD TEST VERIFICATION - VER-2.	All
7	Turn the ignition off. Disconnect the A/C Pressure Sensor harness connector. Measure the resistance between ground and the Sensor Ground circuit. Is the resistance below 30 ohms?  Yes → Go To 8  No → Repair the Sensor Ground circuit for an open. Perform ROAD TEST VERIFICATION - VER-2.	All
8	If there are no possible causes remaining, view repair.  Repair Replace and program the Engine Control Module in accordance with the Service Information. Perform ROAD TEST VERIFICATION - VER-2.	All

**P0530-A/C PRESSURE SENSOR CIRCUIT SIGNAL VOLTAGE TOO HIGH**

— Continued

TEST	ACTION	APPLICABILITY
9	<p><b>WARNING: WHEN THE ENGINE IS OPERATING, DO NOT STAND IN A DIRECT LINE WITH THE FAN. DO NOT PUT YOUR HANDS NEAR THE PULLEYS, BELTS OR FAN. DO NOT WEAR LOOSE CLOTHING.</b></p> <p><b>NOTE: The conditions that set the DTC are not present at this time. The following list may help in identifying the intermittent condition.</b></p> <p>With the engine running and at normal operating temperature, monitor the DRB parameters related to the DTC while wiggling the wiring harness. Look for parameter values to change and/or a DTC to set.</p> <p>Review the DTC When Monitored and Set Conditions. If possible, try to duplicate the conditions under which the DTC was set.</p> <p>Refer to any Technical Service Bulletins (TSB) that may apply.</p> <p>Visually inspect the related wiring harness. Look for any chafed, pierced, pinched, or partially broken wires.</p> <p>Visually inspect the related wiring harness connectors. Look for broken, bent, pushed out, or corroded terminals.</p> <p>Were any of the above conditions present?</p> <p style="padding-left: 40px;">Yes → Repair as necessary. Perform ROAD TEST VERIFICATION - VER-2.</p> <p style="padding-left: 40px;">No → Test Complete.</p>	All
10	<p>Turn the ignition off.</p> <p>Disconnect the A/C Pressure Sensor harness connector.</p> <p>Turn the ignition on.</p> <p>Measure the voltage of the Sensor Reference Voltage B circuit in the A/C Pressure Sensor harness connector.</p> <p>Is the voltage between 4.5 and 5.5 volts?</p> <p style="padding-left: 40px;">Yes → Go To 11</p> <p style="padding-left: 40px;">No → Go To 15</p>	All
11	<p>Turn the ignition off.</p> <p>Disconnect the A/C Pressure Sensor harness connector.</p> <p>Turn the ignition on.</p> <p>With the DRBIII<sup>®</sup>, monitor the A/C Pressure Sensor voltage.</p> <p>Is the voltage above 0.7 volt?</p> <p style="padding-left: 40px;">Yes → Replace the A/C Pressure Sensor. Perform ROAD TEST VERIFICATION - VER-2.</p> <p style="padding-left: 40px;">No → Go To 12</p>	All
12	<p>Turn the ignition off.</p> <p>Disconnect the A/C Pressure Sensor harness connector.</p> <p>Disconnect the ECM harness connectors.</p> <p>Measure the resistance between ground and the A/C Pressure Sensor Signal circuit.</p> <p>Is the resistance above 100 kohms?</p> <p style="padding-left: 40px;">Yes → Go To 13</p> <p style="padding-left: 40px;">No → Repair the A/C Pressure Sensor Signal circuit for a short to ground. Perform ROAD TEST VERIFICATION - VER-2.</p>	All

**P0530-A/C PRESSURE SENSOR CIRCUIT SIGNAL VOLTAGE TOO HIGH**  
 — Continued

TEST	ACTION	APPLICABILITY
13	Turn the ignition off. Disconnect the A/C Pressure Sensor harness connector. Disconnect the ECM harness connectors. Measure the resistance between the A/C Pressure Sensor Signal circuit and the Sensor Ground circuit. Is the resistance above 100 kohms?  Yes → Go To 14  No → Repair the A/C Pressure Sensor Signal circuit for a short to the Sensor Ground circuit. Perform ROAD TEST VERIFICATION - VER-2.	All
14	If there are no possible causes remaining, view repair.  Repair Replace and program the Engine Control Module in accordance with the Service Information. Perform ROAD TEST VERIFICATION - VER-2.	All
15	Turn the ignition off. Disconnect the A/C Pressure Sensor harness connector. Disconnect the ECM harness connectors. Measure the resistance of the Sensor Reference Voltage B circuit. Is the resistance below 5 ohms?  Yes → Go To 16  No → Repair the Sensor Reference Voltage B circuit for an open. Perform ROAD TEST VERIFICATION - VER-2.	All
16	If there are no possible causes remaining, view repair.  Repair Replace and program the Engine Control Module in accordance with the Service Information. Perform ROAD TEST VERIFICATION - VER-2.	All

**Symptom:****P0560-SYSTEM VOLTAGE TOO HIGH****When Monitored and Set Condition:****P0560-SYSTEM VOLTAGE TOO HIGH**

When Monitored: With the engine running.

Set Condition: The ECM detects battery voltage is above 15.5 volts.

**POSSIBLE CAUSES**

GROUND CIRCUIT HIGH RESISTANCE

BATTERY SUPPLY OR ASD RELAY OUTPUT CIRCUIT HIGH RESISTANCE

GENERATOR FIELD CONTROL CIRCUIT SHORTED TO GROUND

GENERATOR INTERNALLY SHORTED TO GROUND

ENGINE CONTROL MODULE

TEST	ACTION	APPLICABILITY
1	<p><b>NOTE: If DTC P1511 or P1512 is present with this DTC, diagnose DTCs P1511 and P1512 before diagnosing this DTC.</b></p> <p><b>NOTE: The battery must be fully charged and the generator belt must be in good condition and tensioned properly before continuing.</b></p> <p>Turn the ignition off.            Disconnect the ECM harness connectors.            Using a 12-volt test light connected to 12-volts, check all of the ECM Ground circuits including the Battery(-) Sense circuit.            Does the test light illuminate brightly for each circuit?</p> <p>Yes → Go To 2</p> <p>No → Repair the Ground circuit(s) for high resistance.            Perform CHARGING VERIFICATION - VER-3.</p>	All
2	<p>Turn the ignition off.            Disconnect the ECM harness connectors.            Remove the ASD Relay from the PDC.            Connect a jumper wire between cavity 30 and cavity 87 of the ASD Relay connector.            Turn the ignition on.            Using a 12-volt test light connected to ground, check all of the ECM Battery Supply and ASD Relay Output circuits including the Battery(+) Sense circuit.            Does the test light illuminate brightly for each circuit?</p> <p>Yes → Go To 3</p> <p>No → Repair the Battery Supply or ASD Relay Output circuit(s) for high resistance.            Perform CHARGING VERIFICATION - VER-3.</p>	All

**P0560-SYSTEM VOLTAGE TOO HIGH — Continued**

TEST	ACTION	APPLICABILITY
3	Turn the ignition off. Disconnect ECM harness connectors. Disconnect the Generator Field harness connector. Measure the resistance between ground and the Generator Field Control circuit. Is the resistance above 100 kohms?  Yes → Go To 4  No → Repair the Generator Field Control circuit for a short to ground. Perform CHARGING VERIFICATION - VER-3.	All
4	Turn the ignition off. Disconnect the Generator Field harness connector. Measure the resistance between ground and the Generator Field Control terminal on the back of the Generator. Is the resistance above 100 kohms?  Yes → Replace and program the Engine Control Module in accordance with the Service Information. Perform CHARGING VERIFICATION - VER-3.  No → Repair or replace the Generator as necessary. Perform CHARGING VERIFICATION - VER-3.	All

**Symptom List:****P0560-SYSTEM VOLTAGE TOO LOW****P1536-GENERATOR FIELD CURRENT TOO HIGH****\*CHECKING THE CHARGING SYSTEM OPERATION - DIESEL**

**Test Note:** All symptoms listed above are diagnosed using the same tests.  
The title for the tests will be **P0560-SYSTEM VOLTAGE TOO LOW.**

**When Monitored and Set Condition:****P0560-SYSTEM VOLTAGE TOO LOW**

When Monitored: With the engine running.

Set Condition: The ECM detects battery voltage is below 8.0 volts.

**P1536-GENERATOR FIELD CURRENT TOO HIGH**

When Monitored: With the engine running.

Set Condition: The ECM detects the current on the Generator Field above 10.7 amps.

**POSSIBLE CAUSES**

INTERMITTENT CONDITION

GENERATOR BELT CONDITION OR TENSION

GENERATOR FIELD

HIGH RESISTANCE IN THE VOLTAGE SUPPLY CIRCUIT(S) TO THE ECM

GENERATOR FIELD CONTROL CIRCUIT SHORTED TO VOLTAGE

GENERATOR FUSED B+ CIRCUIT HIGH RESISTANCE

GENERATOR FIELD CONTROL CIRCUIT OPEN

GENERATOR FIELD CONTROL CIRCUIT SHORTED TO GROUND

GENERATOR GROUND CIRCUIT HIGH RESISTANCE

BODY GROUND CIRCUIT OPEN

FUSED ASD RELAY OUTPUT CIRCUIT TO GENERATOR OPEN

ENGINE CONTROL MODULE

HIGH RESISTANCE ON THE BATTERY(+) SENSE CIRCUIT

HIGH RESISTANCE ON THE BATTERY(-) SENSE CIRCUIT

**P0560-SYSTEM VOLTAGE TOO LOW — Continued**

TEST	ACTION	APPLICABILITY
1	<p><b>NOTE: If there are any Battery Sense DTCs (P1511 or P1512) present with this DTC, diagnose the Battery Sense DTCs first.</b></p> <p><b>NOTE: Inspect the vehicle for aftermarket accessories that may exceed the Generator capacity.</b></p> <p><b>NOTE: The battery must be fully charged before continuing.</b></p> <p>Inspect the generator belt condition and tension. Is the generator belt in good condition and tensioned properly?</p> <p>Yes → Go To 2</p> <p>No → Repair as necessary. Perform CHARGING VERIFICATION - VER-3.</p>	All
2	<p>Turn the ignition on. With the DRB, erase ECM DTCs. Start the engine several times. Allow the engine to run for at least 30 seconds each run cycle while turning the ignition off for at least 10 seconds between each run cycle. Monitor the DRB for ECM DTCs. Did this DTC set again?</p> <p>Yes → Go To 3</p> <p>No → Go To 14</p>	All
3	<p>Connect the positive lead of a voltmeter to the generator B+ (12V) terminal and the negative lead to the battery positive (+) post. <b>WARNING: WHEN THE ENGINE IS OPERATING, DO NOT STAND IN A DIRECT LINE WITH THE FAN. DO NOT PUT YOUR HANDS NEAR THE PULLEYS, BELTS OR FAN. DO NOT WEAR LOOSE CLOTHING.</b> Start the engine. Is the voltage on the voltmeter below 0.4 volt?</p> <p>Yes → Go To 4</p> <p>No → Repair the Generator Fused B+ circuit for high resistance. Perform CHARGING VERIFICATION - VER-3.</p>	All
4	<p>Connect the positive lead of a voltmeter to the generator case (housing) and the negative lead to the battery negative (-) post. <b>WARNING: WHEN THE ENGINE IS OPERATING, DO NOT STAND IN A DIRECT LINE WITH THE FAN. DO NOT PUT YOUR HANDS NEAR THE PULLEYS, BELTS OR FAN. DO NOT WEAR LOOSE CLOTHING.</b> Start the engine. Is the voltage on the voltmeter below 0.4 volt?</p> <p>Yes → Go To 5</p> <p>No → Repair the Generator Ground circuit for high resistance. Perform CHARGING VERIFICATION - VER-3.</p>	All
5	<p>Turn the ignition off. Measure the voltage between the body and the negative battery terminal. Is the voltage below 0.4 volt?</p> <p>Yes → Go To 6</p> <p>No → Repair the Body Ground circuit for an open. Perform CHARGING VERIFICATION - VER-3.</p>	All

**P0560-SYSTEM VOLTAGE TOO LOW — Continued**

TEST	ACTION	APPLICABILITY
6	Turn the ignition off. Disconnect the Generator Field harness connector. Measure the resistance of the Field Control terminals on the back of the Generator. Is the resistance between 2 and 6 ohms?  Yes → Go To 7  No → Repair or replace the Generator as necessary. Perform CHARGING VERIFICATION - VER-3.	All
7	Turn the ignition off. With a voltmeter, measure and record the voltage between the Battery terminals. Disconnect the ECM harness connectors. Remove the ASD Relay from the PDC. Connect a jumper wire between cavity 30 and cavity 87 of the ASD Relay connector. Turn the ignition on. Measure the voltage of the ASD Relay Output circuits and Battery(+) Sense circuit in the ECM C1 harness connector. Are all voltage measurements within 0.5 volt of each other?  Yes → Go To 8  No → Repair the circuit that had high resistance. Perform CHARGING VERIFICATION - VER-3.	All
8	Turn the ignition off. Disconnect the ECM harness connectors. Disconnect the Generator Field harness connector. Remove the ASD Relay from the PDC. Connect a jumper wire between cavity 30 and cavity 87 of the ASD Relay connector. Turn the ignition on. Measure the voltage of the Generator Field Control circuit. Is the voltage below 1.0 volt?  Yes → Go To 9  No → Repair the Generator Field Control circuit for a short to voltage. Perform CHARGING VERIFICATION - VER-3.	All
9	Turn the ignition off. Disconnect ECM harness connectors. Disconnect the Generator Field harness connector. Measure the resistance between ground and the Generator Field Control circuit. Is the resistance above 100 kohms?  Yes → Go To 10  No → Repair the Generator Field Control circuit for a short to ground. Perform CHARGING VERIFICATION - VER-3.	All
10	Turn the ignition off. Disconnect the ECM harness connectors. Disconnect the Generator Field harness connector. Measure the resistance of the Generator Field Control circuit. Is the resistance below 5.0 ohms?  Yes → Go To 11  No → Repair the Generator Field Control circuit for an open. Perform CHARGING VERIFICATION - VER-3.	All



**P0560-SYSTEM VOLTAGE TOO LOW — Continued**

TEST	ACTION	APPLICABILITY
11	Turn the ignition off. Disconnect the generator harness connector. Turn the ignition on. Measure the voltage of the Fused ASD Relay Output circuit. Is the voltage above 10.0 volts?  Yes → Go To 12  No → Repair the Fused ASD Relay Output circuit for an open. Perform CHARGING VERIFICATION - VER-3.	All
12	Turn the ignition off. Disconnect the ECM harness connectors. Remove Fuse 26 from the PDC. Measure the resistance of the Battery(+) Sense circuit. Is the resistance below 5.0 ohms?  Yes → Go To 13  No → Repair the Battery(+) Sense circuit for high resistance. Perform CHARGING VERIFICATION - VER-3.	All
13	Turn the ignition off. Disconnect the ECM harness connectors. Measure the resistance of the Battery(-) Sense circuit. Is the resistance below 5.0 ohms?  Yes → Replace and program the Engine Control Module in accordance with the Service Information. Perform CHARGING VERIFICATION - VER-3.  No → Repair the Battery(-) Sense circuit for high resistance. Perform CHARGING VERIFICATION - VER-3.	All
14	<p><b>WARNING: WHEN THE ENGINE IS OPERATING, DO NOT STAND IN A DIRECT LINE WITH THE FAN. DO NOT PUT YOUR HANDS NEAR THE PULLEYS, BELTS OR FAN. DO NOT WEAR LOOSE CLOTHING.</b></p> <p><b>NOTE: The conditions that set the DTC are not present at this time. The following list may help in identifying the intermittent condition.</b></p> With the engine running at normal operating temperature, monitor the DRB parameters related to the DTC while wiggling the wiring harness. Look for parameter values to change and/or a DTC to set. Review the DTC When Monitored and Set Conditions. If possible, try to duplicate the conditions under which the DTC was set. Refer to any Technical Service Bulletins (TSB) that may apply. Visually inspect the related wiring harness. Look for any chafed, pierced, pinched, or partially broken wires. Visually inspect the related wiring harness connectors. Look for broken, bent, pushed out, or corroded terminals. Were any of the above conditions present?  Yes → Repair as necessary Perform CHARGING VERIFICATION - VER-3.  No → Test Complete.	All

**Symptom:****P0579-S/C SWITCH SIGNAL CIRCUIT PLAUSIBILITY****POSSIBLE CAUSES**

INTERMITTENT CONDITION

HIGH RESISTANCE IN THE S/C SWITCH SIGNAL CIRCUIT

HIGH RESISTANCE IN THE S/C SWITCH GROUND CIRCUIT

S/C SWITCHES

ENGINE CONTROL MODULE

TEST	ACTION	APPLICABILITY
1	Turn the ignition on. With the DRB, erase ECM DTCs. Test drive the vehicle and activate the Speed Control. At some point during the test drive, actuate each of the S/C Switch buttons. With the DRB, read ECM DTCs. Did this DTC set again?  Yes → Go To 2 No → Go To 5	All
2	Turn the ignition off. Disconnect the S/C Switch harness connectors. Disconnect the ECM harness connectors. Measure the resistance of the S/C Switch Signal circuit. Is the resistance below 5.0 ohms?  Yes → Go To 3 No → Repair the S/C Switch Signal circuit for high resistance. Perform SPEED CONTROL VERIFICATION - VER-4.	All
3	Turn the ignition off. Disconnect the S/C Switch harness connectors. Disconnect the ECM harness connectors. Measure the resistance of the S/C Switch Ground circuit. Is the resistance below 5.0 ohms?  Yes → Go To 4 No → Repair the S/C Switch Ground circuit for high resistance. Perform SPEED CONTROL VERIFICATION - VER-4.	All

**P0579-S/C SWITCH SIGNAL CIRCUIT PLAUSIBILITY — Continued**

TEST	ACTION	APPLICABILITY
4	<p>Turn the ignition off.                      Replace the S/C Switches.                      Turn the ignition on.                      With the DRB, erase ECM DTCs.                      Test drive the vehicle and activate the Speed Control.                      At some point during the test drive, actuate each of the S/C Switch buttons.                      Monitor the DRB for ECM DTCs.                      Did this DTC set again?</p> <p>Yes → Replace and program the Engine Control Module in accordance with the Service Information.                      Perform SPEED CONTROL VERIFICATION - VER-4.</p> <p>No → The repair is complete.                      Perform SPEED CONTROL VERIFICATION - VER-4.</p>	All
5	<p><b>WARNING: WHEN THE ENGINE IS OPERATING, DO NOT STAND IN A DIRECT LINE WITH THE FAN. DO NOT PUT YOUR HANDS NEAR THE PULLEYS, BELTS OR FAN. DO NOT WEAR LOOSE CLOTHING.</b></p> <p><b>NOTE: The conditions that set the DTC are not present at this time. The following list may help in identifying the intermittent condition.</b></p> <p>With the engine running at normal operating temperature, monitor the DRB parameters related to the DTC while wiggling the wiring harness. Look for parameter values to change and/or a DTC to set.                      Review the DTC When Monitored and Set Conditions. If possible, try to duplicate the conditions under which the DTC was set.                      Refer to any Technical Service Bulletins (TSB) that may apply.                      Visually inspect the related wiring harness. Look for any chafed, pierced, pinched, or partially broken wires.                      Visually inspect the related wiring harness connectors. Look for broken, bent, pushed out, or corroded terminals.                      Were any of the above conditions present?</p> <p>Yes → Repair as necessary.                      Perform SPEED CONTROL VERIFICATION - VER-4.</p> <p>No → Test Complete.</p>	All

**Symptom:**

**P0579-S/C SWITCH SIGNAL CIRCUIT SIGNAL VOLTAGE TOO HIGH**

**POSSIBLE CAUSES**

ECM - S/C SIGNAL CIRCUIT OPEN  
 ECM - S/C SIGNAL CIRCUIT SHORTED TO VOLTAGE  
 ECM - SENSOR GROUND OPEN  
 S/C ON/OFF/SET SWITCH  
 S/C ON/OFF/SET SWITCH SIGNAL CIRCUIT OPEN  
 S/C SWITCH SIGNAL CIRCUIT SHORTED TO VOLTAGE  
 SENSOR GROUND OPEN

TEST	ACTION	APPLICABILITY
1	Turn the ignition off. Disconnect the S/C ON/OFF/SET button harness connector. Turn the ignition on. Measure the voltage of the S/C Switch Signal circuit. Select the appropriate voltage reading.  Below 4.5 volts. Go To 2  Between 4.5 and 5.5 volts. Go To 3  Above 5.5 volts Go To 5	All
2	Turn the ignition off. Disconnect the S/C ON/OFF/SET Switch harness connector. Disconnect the ECM harness connectors. Measure the resistance of the S/C Switch Signal circuit. Is the resistance below 10.0 ohms?  Yes → Replace and program the Engine Control Module in accordance with the Service Information. Perform SPEED CONTROL VERIFICATION - VER-4.  No → Repair the S/C ON/OFF/SET Switch Signal circuit for an open. Perform SPEED CONTROL VERIFICATION - VER-4.	All
3	Turn the ignition off. Disconnect the S/C ON/OFF/SET switch harness connector. Turn the ignition on. Connect a jumper wire between the S/C Switch Signal circuit and the Sensor Ground at the ON/OFF/SET Switch harness connector. With the DRB, read the S/C Switch volts. Does the DRB display below 0.5 volt?  Yes → Replace the S/C ON/OFF/SET Switch. Perform SPEED CONTROL VERIFICATION - VER-4.  No → Go To 4	All

**P0579-S/C SWITCH SIGNAL CIRCUIT SIGNAL VOLTAGE TOO HIGH —  
Continued**

TEST	ACTION	APPLICABILITY
4	<p>Turn the ignition off.                      Disconnect the S/C ON/OFF/SET Switch harness connector.                      Disconnect the ECM harness connectors.                      Measure the resistance of the Sensor Ground circuit.                      Is the resistance below 10.0 ohms?</p> <p>Yes → Replace and program the Engine Control Module in accordance with the Service Information.                      Perform SPEED CONTROL VERIFICATION - VER-4.</p> <p>No → Repair the Sensor Ground circuit for an open.                      Perform SPEED CONTROL VERIFICATION - VER-4.</p>	All
5	<p>Turn the ignition off.                      Disconnect the S/C ON/OFF/SET Switch harness connector.                      Disconnect the ECM harness connectors.                      Turn the ignition on.                      Measure the voltage of the S/C Switch Signal circuit.                      Is the voltage above 1.0 volt?</p> <p>Yes → Repair the S/C ON/OFF/SET Switch Signal circuit for a short to voltage.                      Perform SPEED CONTROL VERIFICATION - VER-4.</p> <p>No → Replace and program the Engine Control Module in accordance with the Service Information.                      Perform SPEED CONTROL VERIFICATION - VER-4.</p>	All

**Symptom:****P0579-S/C SWITCH SIGNAL CIRCUIT SIGNAL VOLTAGE TOO LOW****POSSIBLE CAUSES**

INTERMITTENT CONDITION

S/C ON/OFF/SET SWITCH

S/C RESUME/ACCEL SWITCH

S/C SWITCH SIGNAL CIRCUIT SHORTED TO SENSOR GROUND

S/C SWITCH SIGNAL CIRCUIT SHORTED TO GROUND

ECM

<b>TEST</b>	<b>ACTION</b>	<b>APPLICABILITY</b>
1	Turn the ignition on. With the DRBIII®, read the S/C Switch voltage. Is the S/C Switch voltage below 0.4 volt?  Yes → Go To 2  No → Go To 7	All
2	Turn the ignition on. With the DRBIII®, monitor the S/C Switch voltage. Disconnect the S/C ON/OFF/SET Switch harness connector. Did the DRB reading change to above 4.7 volts?  Yes → Replace the S/C ON/OFF/SET Switch. Perform SPEED CONTROL VERIFICATION - VER-4.  No → Go To 3	All
3	Turn the ignition on. With the DRBIII®, monitor the S/C Switch voltage. Disconnect the S/C Resume/Accel Switch harness connector. Did the volt change to above 4.7 volts?  Yes → Replace the S/C Resume/Accel Switch. Perform SPEED CONTROL VERIFICATION - VER-4.  No → Go To 4	All
4	Turn the ignition off. Disconnect the S/C ON/OFF/SET Switch harness connector. Disconnect the S/C RESUME/ACCEL Switch harness connector. Disconnect the ECM harness connectors. Measure the resistance between the S/C Switch Signal circuit and the Sensor Ground circuit in the ECM harness connector. Is the resistance below 5.0 ohms?  Yes → Repair the S/C Switch Signal circuit shorted to the Sensor Ground circuit. Perform SPEED CONTROL VERIFICATION - VER-4.  No → Go To 5	All

**P0579-S/C SWITCH SIGNAL CIRCUIT SIGNAL VOLTAGE TOO LOW —**  
**Continued**

TEST	ACTION	APPLICABILITY
5	Turn the ignition off. Disconnect the S/C ON/OFF/SET Switch harness connector. Disconnect the S/C RESUME/ACCEL Switch harness connector. Disconnect the ECM harness connectors. Measure the resistance between ground and the S/C Switch Signal circuit. Is the resistance below 5.0 ohms?  Yes → Repair the S/C Switch Signal circuit for a short to ground. Perform SPEED CONTROL VERIFICATION - VER-4.  No → Go To 6	All
6	If there are no possible causes remaining, view repair.  Repair Replace the Engine Control Module in accordance with the Service Information. Perform SPEED CONTROL VERIFICATION - VER-4.	All
7	<p><b>WARNING: WHEN THE ENGINE IS OPERATING, DO NOT STAND IN A DIRECT LINE WITH THE FANS. DO NOT PUT YOUR HANDS NEAR THE PULLEYS, BELTS OR FANS. DO NOT WEAR LOOSE CLOTHING.</b></p> <p><b>NOTE: The conditions that set the DTC are not present at this time. The following list may help in identifying the intermittent condition.</b></p> With the engine running at normal operating temperature, monitor the DRB parameters related to the DTC while wiggling the wiring harness. Look for parameter values to change and/or a DTC to set. Review the DTC When Monitored and Set Conditions. If possible, try to duplicate the conditions under which the DTC was set. Refer to any Technical Service Bulletins (TSB) that may apply. Visually inspect the related wiring harness. Look for any chafed, pierced, pinched, or partially broken wires. Visually inspect the related wiring harness connectors. Look for broken, bent, pushed out, or corroded terminals. Were any of the above conditions present?  Yes → Repair as necessary Perform SPEED CONTROL VERIFICATION - VER-4.  No → Test Complete.	All

**Symptom:**

**P0615-STARTER RELAY CIRCUIT SHORT CIRCUIT**

**When Monitored and Set Condition:**

**P0615-STARTER RELAY CIRCUIT SHORT CIRCUIT**

When Monitored: With the ignition on.

Set Condition: The ECM detects excessive current on the Starter Relay Control circuit.

<b>POSSIBLE CAUSES</b>	
INTERMITTENT CONDITION	
SUBSTITUTE ECM/PCM RELAY	
STARTER RELAY CONTROL CIRCUIT SHORTED TO VOLTAGE	
ENGINE CONTROL MODULE	

<b>TEST</b>	<b>ACTION</b>	<b>APPLICABILITY</b>
1	Turn the ignition on. With the DRB, erase ECM DTCs. Attempt to start the engine several times, pausing for at least 10 seconds between each cycle. Turn the ignition on. With the DRB, read ECM DTCs. Did this DTC set again?  Yes → Go To 2 No → Go To 4	All
2	Turn the ignition off. Install a substitute relay in place of the Starter Relay. Attempt to start the engine several times, pausing for at least 10 seconds between each cycle. Turn the ignition on. With the DRB, read ECM DTCs. Did this DTC set again?  Yes → Go To 3 No → Replace the Starter Relay. Perform ROAD TEST VERIFICATION - VER-2.	All



**P0615-STARTER RELAY CIRCUIT SHORT CIRCUIT — Continued**

TEST	ACTION	APPLICABILITY
3	<p>Turn the ignition off.                      Remove the Starter Relay from the PDC.                      Disconnect the ECM harness connectors.                      Remove the ASD Relay from the PDC.                      Connect a jumper wire between cavity 30 and cavity 87 of the ASD Relay connector.                      Turn the ignition on.                      Measure the voltage of the Starter Relay Control circuit.                      Is the voltage below 1.0 volt?</p> <p>Yes → Replace and program the Engine Control Module in accordance with the Service Information.                      Perform ROAD TEST VERIFICATION - VER-2.</p> <p>No → Repair the Starter Relay Control circuit for a short to voltage.                      Perform ROAD TEST VERIFICATION - VER-2.</p>	All
4	<p><b>WARNING: WHEN THE ENGINE IS OPERATING, DO NOT STAND IN A DIRECT LINE WITH THE FAN. DO NOT PUT YOUR HANDS NEAR THE PULLEYS, BELTS OR FAN. DO NOT WEAR LOOSE CLOTHING.</b></p> <p><b>NOTE: The conditions that set the DTC are not present at this time. The following list may help in identifying the intermittent condition.</b></p> <p>With the engine running at normal operating temperature, monitor the DRB parameters related to the DTC while wiggling the wiring harness. Look for parameter values to change and/or a DTC to set.</p> <p>Review the DTC When Monitored and Set Conditions. If possible, try to duplicate the conditions under which the DTC was set.</p> <p>Refer to any Technical Service Bulletins (TSB) that may apply.</p> <p>Visually inspect the related wiring harness. Look for any chafed, pierced, pinched, or partially broken wires.</p> <p>Visually inspect the related wiring harness connectors. Look for broken, bent, pushed out, or corroded terminals.</p> <p>Were any of the above conditions present?</p> <p>Yes → Repair as necessary.                      Perform ROAD TEST VERIFICATION - VER-2.</p> <p>No → Test Complete.</p>	All

**Symptom List:**

**P0620-GENERATOR FIELD CONTROL MALF BATTERY VOLTAGE DEVIATION TOO HIGH**

**P0620-GENERATOR FIELD CONTROL MALF BATTERY VOLTAGE DEVIATION TOO LOW**

**P0620-GENERATOR FIELD CONTROL MALF BATTERY VOLTAGE TOO HIGH**

**P0620-GENERATOR FIELD CONTROL MALF BATTERY VOLTAGE TOO LOW**

**P0620-GENERATOR FIELD CONTROL MALF CHARGING VOLTS TOO LOW**

**P0620-GENERATOR FIELD CONTROL MALF HIGH GENERATOR CURRENT**

**P0620-GENERATOR FIELD CONTROL MALF OPEN CIRCUIT**

**P0620-GENERATOR FIELD CONTROL MALF SHORT CIRCUIT**

---

**Test Note: All symptoms listed above are diagnosed using the same tests. The title for the tests will be P0620-GENERATOR FIELD CONTROL MALF BATTERY VOLTAGE DEVIATION TOO HIGH.**

---

**When Monitored and Set Condition:**

**P0620-GENERATOR FIELD CONTROL MALF BATTERY VOLTAGE DEVIATION TOO HIGH**

When Monitored: With the engine running.

Set Condition: The ECM detects the battery voltage and the ASD voltage difference is greater than 2 volts.

**P0620-GENERATOR FIELD CONTROL MALF BATTERY VOLTAGE DEVIATION TOO LOW**

When Monitored: With the engine running.

Set Condition: The ECM detects the battery voltage and the ASD voltage difference is less than 2 volts.

**P0620-GENERATOR FIELD CONTROL MALF BATTERY VOLTAGE TOO HIGH**

When Monitored: With the engine running.

Set Condition: The ECM senses battery voltage above 15.5 volts.

**P0620-GENERATOR FIELD CONTROL MALF BATTERY VOLTAGE TOO LOW**

When Monitored: With the engine running.

Set Condition: The ECM detects the battery voltage is less than 8.0 volts.

**P0620-GENERATOR FIELD CONTROL MALF BATTERY VOLTAGE DEVIATION TOO HIGH — Continued**

**P0620-GENERATOR FIELD CONTROL MALF CHARGING VOLTS TOO LOW**

When Monitored: With the engine running.

Set Condition: The ECM senses battery voltage that is 1volt or more below desired charging voltage.

**P0620-GENERATOR FIELD CONTROL MALF HIGH GENERATOR CURRENT**

When Monitored: With the engine running.

Set Condition: The ECM detects a higher current than should be.

**P0620-GENERATOR FIELD CONTROL MALF OPEN CIRCUIT**

When Monitored: With the ignition on.

Set Condition: The ECM detects an open or short to ground on the Generator Field Control circuit.

**P0620-GENERATOR FIELD CONTROL MALF SHORT CIRCUIT**

When Monitored: With the ignition on.

Set Condition: The ECM detects excessive current on the Generator Field Control circuit.

**POSSIBLE CAUSES**

INTERMITTENT CONDITION  
 GENERATOR BELT CONDITION OR TENSION  
 GENERATOR FIELD  
 GENERATOR FIELD CONTROL CIRCUIT SHORTED TO VOLTAGE  
 GENERATOR FIELD CONTROL CIRCUIT SHORTED TO GROUND  
 GENERATOR FIELD CONTROL CIRCUIT OPEN  
 HIGH RESISTANCE ON THE BATTERY(+) SENSE CIRCUIT  
 HIGH RESISTANCE ON THE BATTERY(-) SENSE CIRCUIT  
 ENGINE CONTROL MODULE

TEST	ACTION	APPLICABILITY
1	<p><b>NOTE: If there are any Battery Sense DTCs (P1511 or P1512) present with this DTC, diagnose the Battery Sense DTCs first.</b>  <b>NOTE: Inspect the vehicle for aftermarket accessories that may exceed the Generator capacity.</b>  <b>NOTE: The battery must be fully charged before continuing.</b>                      Inspect the generator belt condition and tension.                      Is the generator belt in good condition and tensioned properly?</p> <p>Yes → Go To 2</p> <p>No → Repair as necessary.                      Perform CHARGING VERIFICATION - VER-3.</p>	All

## P0620-GENERATOR FIELD CONTROL MALF BATTERY VOLTAGE DEVIATION TOO HIGH — Continued

TEST	ACTION	APPLICABILITY
2	<p>Turn the ignition on.            With the DRB, erase ECM DTCs.            Start the engine several times. Allow the engine to run for at least 30 seconds each run cycle while turning the ignition off for at least 10 seconds between each run cycle.            Monitor the DRB for ECM DTCs.            Did this DTC set again?</p> <p>Yes → Go To 3            No → Go To 10</p>	All
3	<p>Turn the ignition off.            Disconnect the Generator Field harness connector.            Measure the resistance of the Field Control terminals on the back of the Generator.            Is the resistance between 2 and 6 ohms?</p> <p>Yes → Go To 4            No → Repair or replace the Generator as necessary.            Perform CHARGING VERIFICATION - VER-3.</p>	All
4	<p>Turn the ignition off.            Disconnect the ECM harness connectors.            Disconnect the Generator Field harness connector.            Remove the ASD Relay from the PDC.            Connect a jumper wire between cavity 30 and cavity 87 of the ASD Relay connector.            Turn the ignition on.            Measure the voltage of the Generator Field Control circuit.            Is the voltage below 1.0 volt?</p> <p>Yes → Go To 5            No → Repair the Generator Field Control circuit for a short to voltage.            Perform CHARGING VERIFICATION - VER-3.</p>	All
5	<p>Turn the ignition off.            Disconnect ECM harness connectors.            Disconnect the Generator Field harness connector.            Measure the resistance between ground and the Generator Field Control circuit.            Is the resistance above 100 kohms?</p> <p>Yes → Go To 6            No → Repair the Generator Field Control circuit for a short to ground.            Perform CHARGING VERIFICATION - VER-3.</p>	All
6	<p>Turn the ignition off.            Disconnect the ECM harness connectors.            Disconnect the Generator Field harness connector.            Measure the resistance of the Generator Field Control circuit.            Is the resistance below 5.0 ohms?</p> <p>Yes → Go To 7            No → Repair the Generator Field Control circuit for an open.            Perform CHARGING VERIFICATION - VER-3.</p>	All

**P0620-GENERATOR FIELD CONTROL MALF BATTERY VOLTAGE DEVIATION TOO HIGH — Continued**

TEST	ACTION	APPLICABILITY
7	Turn the ignition off. Disconnect the ECM harness connectors. Remove Fuse 26 from the PDC. Measure the resistance of the Battery(+) Sense circuit. Is the resistance below 5.0 ohms?  Yes → Go To 8  No → Repair the Battery(+) Sense circuit for high resistance. Perform CHARGING VERIFICATION - VER-3.	All
8	Turn the ignition off. Disconnect the ECM harness connectors. Measure the resistance of the Battery(-) Sense circuit. Is the resistance below 5.0 ohms?  Yes → Go To 9  No → Repair the Battery(-) Sense circuit for high resistance. Perform CHARGING VERIFICATION - VER-3.	All
9	If there are no possible causes remaining, view repair.  Repair Replace and program the Engine Control Module in accordance with the Service Information. Perform CHARGING VERIFICATION - VER-3.	All
10	<p><b>WARNING: WHEN THE ENGINE IS OPERATING, DO NOT STAND IN A DIRECT LINE WITH THE FAN. DO NOT PUT YOUR HANDS NEAR THE PULLEYS, BELTS OR FAN. DO NOT WEAR LOOSE CLOTHING.</b></p> <p><b>NOTE: The conditions that set the DTC are not present at this time. The following list may help in identifying the intermittent condition.</b></p> With the engine running at normal operating temperature, monitor the DRB parameters related to the DTC while wiggling the wiring harness. Look for parameter values to change and/or a DTC to set. Review the DTC When Monitored and Set Conditions. If possible, try to duplicate the conditions under which the DTC was set. Refer to any Technical Service Bulletins (TSB) that may apply. Visually inspect the related wiring harness. Look for any chafed, pierced, pinched, or partially broken wires. Visually inspect the related wiring harness connectors. Look for broken, bent, pushed out, or corroded terminals. Were any of the above conditions present?  Yes → Repair as necessary Perform CHARGING VERIFICATION - VER-3.  No → Test Complete.	All

**Symptom:**

**P0641-SENSOR REFERENCE VOLTAGE A CKT VOLTAGE TOO HIGH**

**When Monitored and Set Condition:**

**P0641-SENSOR REFERENCE VOLTAGE A CKT VOLTAGE TOO HIGH**

When Monitored: With the ignition on.

Set Condition: The ECM detects a short to voltage on the Sensor Reference Voltage A circuit or the Fuel Pressure Sensor 5-Volt Supply circuit.

POSSIBLE CAUSES	
INTERMITTENT CONDITION	
SENSOR REFERENCE VOLTAGE A SHORTED TO VOLTAGE	
ENGINE CONTROL MODULE	
FUEL PRESSURE SENSOR 5 VOLT SUPPLY CIRCUIT SHORTED TO VOLTAGE	

TEST	ACTION	APPLICABILITY
1	Turn the ignition on. With the DRB, erase ECM DTCs. Monitor the DRB for ECM DTCs. Did this DTC set again?  Yes → Go To 2  No → Go To 5	All
2	Turn the ignition off. Disconnect the MAF and APP Sensor harness connectors. Disconnect the ECM harness connectors. Remove the ASD Relay from the PDC. Connect a jumper wire between cavity 30 and cavity 87 of the ASD Relay connector. Turn the ignition on. Measure the voltage on the Sensor Reference Voltage A circuit. Is the voltage above 1.0 volt?  Yes → Repair the Sensor Reference Voltage A circuit for a short to voltage. Perform ROAD TEST VERIFICATION - VER-2.  No → Go To 3  <b>NOTE: Remove the jumper wire and reinstall the ASD Relay.</b>	All

**P0641-SENSOR REFERENCE VOLTAGE A CKT VOLTAGE TOO HIGH —**  
**Continued**

TEST	ACTION	APPLICABILITY
3	Turn the ignition off. Disconnect the Fuel Pressure Sensor harness connector. Disconnect the ECM harness connectors. Remove the ASD Relay from the PDC. Connect a jumper wire between cavity 30 and cavity 87 of the ASD Relay connector. Turn the ignition on. Measure the voltage on the Fuel Pressure Sensor 5-Volt Supply circuit. Is the voltage below 1.0 volt?  Yes → Go To 4  No → Repair the Fuel Pressure Sensor 5-Volt Supply circuit for a short to voltage. Perform ROAD TEST VERIFICATION - VER-2.  <b>NOTE: Remove the jumper wire and reinstall the ASD Relay.</b>	All
4	If there are no possible causes remaining, view repair.  Repair Replace and program the Engine Control Module in accordance with the Service Information. Perform ROAD TEST VERIFICATION - VER-2.	All
5	<b>WARNING: WHEN THE ENGINE IS OPERATING, DO NOT STAND IN A DIRECT LINE WITH THE FAN. DO NOT PUT YOUR HANDS NEAR THE PULLEYS, BELTS OR FAN. DO NOT WEAR LOOSE CLOTHING.</b> <b>NOTE: The conditions that set the DTC are not present at this time. The following list may help in identifying the intermittent condition.</b> With the engine running at normal operating temperature, monitor the DRB parameters related to the DTC while wiggling the wiring harness. Look for parameter values to change and/or a DTC to set. Review the DTC When Monitored and Set Conditions. If possible, try to duplicate the conditions under which the DTC was set. Refer to any Technical Service Bulletins (TSB) that may apply. Visually inspect the related wiring harness. Look for any chafed, pierced, pinched, or partially broken wires. Visually inspect the related wiring harness connectors. Look for broken, bent, pushed out, or corroded terminals. Were any of the above conditions present?  Yes → Repair as necessary. Perform ROAD TEST VERIFICATION - VER-2.  No → Test Complete.	All

**Symptom:**

**P0641-SENSOR REFERENCE VOLTAGE A CKT VOLTAGE TOO LOW**

**When Monitored and Set Condition:**

**P0641-SENSOR REFERENCE VOLTAGE A CKT VOLTAGE TOO LOW**

When Monitored: With the ignition on.

Set Condition: The ECM detects a short to ground on the Sensor Reference Voltage A circuit or a short to ground on the Fuel Pressure Sensor 5-Volt Supply circuit.

**POSSIBLE CAUSES**

INTERMITTENT CONDITION  
 FUEL PRESSURE SENSOR SHORTED TO GROUND  
 MASS AIR FLOW SENSOR SHORTED TO GROUND  
 ACCELERATOR PEDAL POSITION SENSOR 2 SHORTED TO GROUND  
 SENSOR REFERENCE VOLTAGE A CIRCUIT SHORTED TO GROUND  
 SENSOR REFERENCE VOLTAGE A CIRCUIT SHORTED TO SENSOR GROUND  
 FUEL PRESSURE SENSOR 5-VOLT SUPPLY CIRCUIT SHORTED TO GROUND  
 FUEL PRESSURE SENSOR 5-VOLT SUPPLY CIRCUIT SHORTED TO SENSOR GROUND  
 ENGINE CONTROL MODULE

TEST	ACTION	APPLICABILITY
1	Turn the ignition on. With the DRB, erase ECM DTCs. Monitor the DRB for ECM DTCs. Did this DTC set again?  Yes → Go To 2 No → Go To 10	All
2	Turn the ignition off. Disconnect the Fuel Pressure Sensor harness connector. Turn the ignition on. Measure the voltage of the Fuel Pressure Sensor 5-Volt Supply circuit. Is the voltage above 4.8 volts?  Yes → Replace the Fuel Pressure Sensor. Perform ROAD TEST VERIFICATION - VER-2.  No → Go To 3	All



**P0641-SENSOR REFERENCE VOLTAGE A CKT VOLTAGE TOO LOW — Continued**

TEST	ACTION	APPLICABILITY
3	Turn the ignition off. Disconnect the MAF Sensor harness connector. Turn the ignition on. Measure the voltage of the Sensor Reference Voltage A circuit. Is the voltage above 4.8 volts?  Yes → Replace the Mass Air Flow Sensor. Perform ROAD TEST VERIFICATION - VER-2.  No → Go To 4	All
4	Turn the ignition off. Disconnect the Accelerator Pedal Position Sensor harness connector. Turn the ignition on. Measure the voltage of the Sensor Reference Voltage A circuit. Is the voltage above 4.8 volts?  Yes → Replace the Accelerator Pedal Position Sensor. Perform ROAD TEST VERIFICATION - VER-2.  No → Go To 5	All
5	Turn the ignition off. Disconnect the ECM harness connectors. Disconnect the MAF Sensor and Accelerator Pedal Position Sensor harness connectors. Measure the resistance between ground and the Sensor Reference Voltage A circuit. Is the resistance above 100 kohms?  Yes → Go To 6  No → Repair the Sensor Reference Voltage A circuit for a short to ground. Perform ROAD TEST VERIFICATION - VER-2.	All
6	Turn the ignition off. Disconnect the ECM harness connectors. Disconnect the MAF Sensor harness connector. Measure the resistance between the Sensor Reference Voltage A circuit and the MAF Sensor Ground circuit. Disconnect the Accelerator Pedal Position Sensor harness connector. Measure the resistance between the Sensor Reference Voltage A circuit and both Accelerator Pedal Position Sensor Ground circuits. Is the resistance above 100 kohms for each measurement?  Yes → Go To 7  No → Repair the Sensor Reference Voltage A circuit for a short to the Sensor Ground circuit that measured below 100 kohms. Perform ROAD TEST VERIFICATION - VER-2.	All

## P0641-SENSOR REFERENCE VOLTAGE A CKT VOLTAGE TOO LOW — Continued

TEST	ACTION	APPLICABILITY
7	<p>Turn the ignition off. Disconnect the ECM harness connectors. Disconnect the Fuel Pressure Sensor harness connector. Measure the resistance between ground and the Fuel Pressure Sensor 5-Volt Supply circuit. Is the resistance above 100 kohms?</p> <p>Yes → Go To 8</p> <p>No → Repair the Fuel Pressure Sensor 5-Volt Supply circuit for a short to ground. Perform ROAD TEST VERIFICATION - VER-2.</p>	All
8	<p>Turn the ignition off. Disconnect the ECM harness connectors. Disconnect the Fuel Pressure Sensor harness connector. Measure the resistance between the Fuel Pressure Sensor 5-Volt Supply circuit and the Sensor Ground circuit. Is the resistance above 100 kohms?</p> <p>Yes → Go To 9</p> <p>No → Repair the Fuel Pressure Sensor 5-Volt Supply circuit for a short to the Sensor Ground circuit. Perform ROAD TEST VERIFICATION - VER-2.</p>	All
9	<p>If there are no possible causes remaining, view repair.</p> <p>Repair</p> <p>Replace and program the Engine Control Module in accordance with the Service Information. Perform ROAD TEST VERIFICATION - VER-2.</p>	All
10	<p><b>WARNING: WHEN THE ENGINE IS OPERATING, DO NOT STAND IN A DIRECT LINE WITH THE FAN. DO NOT PUT YOUR HANDS NEAR THE PULLEYS, BELTS OR FAN. DO NOT WEAR LOOSE CLOTHING.</b></p> <p><b>NOTE: The conditions that set the DTC are not present at this time. The following list may help in identifying the intermittent condition.</b></p> <p>With the engine running at normal operating temperature, monitor the DRB parameters related to the DTC while wiggling the wiring harness. Look for parameter values to change and/or a DTC to set. Review the DTC When Monitored and Set Conditions. If possible, try to duplicate the conditions under which the DTC was set. Refer to any Technical Service Bulletins (TSB) that may apply. Visually inspect the related wiring harness. Look for any chafed, pierced, pinched, or partially broken wires. Visually inspect the related wiring harness connectors. Look for broken, bent, pushed out, or corroded terminals. Were any of the above conditions present?</p> <p>Yes → Repair as necessary. Perform ROAD TEST VERIFICATION - VER-2.</p> <p>No → Test Complete.</p>	All

**Symptom:**

**P0645-A/C CLUTCH RELAY CIRCUIT OPEN CIRCUIT**

**When Monitored and Set Condition:**

**P0645-A/C CLUTCH RELAY CIRCUIT OPEN CIRCUIT**

When Monitored: With the ignition on.

Set Condition: The ECM does not detect voltage on the A/C Clutch Relay Control circuit.

**POSSIBLE CAUSES**

INTERMITTENT CONDITION  
 FUSED ASD RELAY OUTPUT CIRCUIT OPEN  
 A/C CLUTCH RELAY  
 A/C CLUTCH RELAY CONTROL CKT OPEN  
 A/C CLUTCH RELAY CONTROL CIRCUIT SHORT TO GROUND  
 ECM

TEST	ACTION	APPLICABILITY
1	Turn the ignition on. With the DRBIII®, actuate the A/C Clutch Relay. Is the A/C Clutch Relay operating?  Yes → Go To 2  No → Go To 3	All
2	<p><b>WARNING: WHEN THE ENGINE IS OPERATING, DO NOT STAND IN A DIRECT LINE WITH THE FAN. DO NOT PUT YOUR HANDS NEAR THE PULLEYS, BELTS OR FAN. DO NOT WEAR LOOSE CLOTHING.</b></p> <p><b>NOTE: The conditions that set the DTC are not present at this time. The following list may help in identifying the intermittent condition.</b></p> With the engine running at normal operating temperature, monitor the DRB parameters related to the DTC while wiggling the wiring harness. Look for parameter values to change and/or a DTC to set. Review the DTC When Monitored and Set Conditions. If possible, try to duplicate the conditions under which the DTC was set. Refer to any Technical Service Bulletins (TSB) that may apply. Visually inspect the related wiring harness. Look for any chafed, pierced, pinched, or partially broken wires. Visually inspect the related wiring harness connectors. Look for broken, bent, pushed out, or corroded terminals. Were any of the above conditions present?  Yes → Repair as necessary. Perform ROAD TEST VERIFICATION - VER-2.  No → Test Complete.	All

**P0645-A/C CLUTCH RELAY CIRCUIT OPEN CIRCUIT — Continued**

TEST	ACTION	APPLICABILITY
3	Turn the ignition off. Remove the A/C Clutch Relay from the PDC. Turn the ignition on. Using a 12-volt test light connected to ground, probe the Fused ASD Relay Output circuit in the PDC. Does the test light illuminate?  Yes → Go To 4  No → Repair the Fused ASD Relay Output circuit for an open. Perform ROAD TEST VERIFICATION - VER-2.	All
4	Turn the ignition off. Remove the A/C Clutch Relay from the PDC. Turn the ignition on. Using a 12-volt test light connected to 12-volts, probe the A/C Clutch Relay Control circuit in the PDC. With the DRBIII®, actuate the A/C Clutch Relay. Does the test light cycle on and off?  Yes → Replace the A/C Clutch Relay. Perform ROAD TEST VERIFICATION - VER-2.  No → Go To 5	All
5	Turn the ignition off. Remove the A/C Clutch Relay from the PDC. Disconnect the ECM harness connector. Measure the resistance of the A/C Clutch Relay Control circuit. Is the resistance below 5.0 ohms?  Yes → Go To 6  No → Repair the A/C Clutch Relay Control circuit for an open. Perform ROAD TEST VERIFICATION - VER-2.	All
6	Turn the ignition off. Remove the A/C Clutch Relay from the PDC. Disconnect the ECM harness connector. Measure the resistance between ground and the A/C Clutch Relay Control circuit. Is the resistance below 5.0 ohms?  Yes → Repair the A/C Clutch Relay Control circuit for a short to ground. Perform ROAD TEST VERIFICATION - VER-2.  No → Go To 7	All
7	If there are no possible causes remaining, view repair.  Repair Replace and program the Engine Control Module in accordance with the Service Information. Perform ROAD TEST VERIFICATION - VER-2.	All

**Symptom:**

**P0645-A/C CLUTCH RELAY CIRCUIT SHORT CIRCUIT**

**When Monitored and Set Condition:**

**P0645-A/C CLUTCH RELAY CIRCUIT SHORT CIRCUIT**

When Monitored: With the ignition off.

Set Condition: The ECM detects excessive current on the A/C Clutch Relay Control circuit.

**POSSIBLE CAUSES**

INTERMITTENT CONDITION

A/C CLUTCH RELAY

A/C CLUTCH RELAY CONTROL CIRCUIT SHORTED TO VOLTAGE

ECM

TEST	ACTION	APPLICABILITY
1	Turn the ignition on. With the DRBIII®, actuate the A/C Clutch Relay. Is the A/C Clutch Relay operating?  Yes → Go To 2  No → Go To 3	All
2	<p><b>WARNING: WHEN THE ENGINE IS OPERATING, DO NOT STAND IN A DIRECT LINE WITH THE FAN. DO NOT PUT YOUR HANDS NEAR THE PULLEYS, BELTS OR FAN. DO NOT WEAR LOOSE CLOTHING.</b></p> <p><b>NOTE: The conditions that set the DTC are not present at this time. The following list may help in identifying the intermittent condition.</b></p> With the engine running at normal operating temperature, monitor the DRB parameters related to the DTC while wiggling the wiring harness. Look for parameter values to change and/or a DTC to set. Review the DTC When Monitored and Set Conditions. If possible, try to duplicate the conditions under which the DTC was set. Refer to any Technical Service Bulletins (TSB) that may apply. Visually inspect the related wiring harness. Look for any chafed, pierced, pinched, or partially broken wires. Visually inspect the related wiring harness connectors. Look for broken, bent, pushed out, or corroded terminals. Were any of the above conditions present?  Yes → Repair as necessary. Perform ROAD TEST VERIFICATION - VER-2.  No → Test Complete.	All

**P0645-A/C CLUTCH RELAY CIRCUIT SHORT CIRCUIT — Continued**

TEST	ACTION	APPLICABILITY
3	Turn the ignition off. Remove the A/C Clutch Relay from the PDC. Turn the ignition on. Using a 12-volt test light connected to 12-volts, probe the A/C Clutch Relay Control circuit in the PDC. With the DRBIII®, actuate the A/C Clutch Relay. Does the test light cycle on and off?  Yes → Replace the A/C Clutch Relay. Perform ROAD TEST VERIFICATION - VER-2.  No → Go To 4	All
4	Turn the ignition off. Remove the A/C Clutch Relay from the PDC. Disconnect the ECM harness connector. Remove the ASD Relay from the PDC. Connect a jumper wire between cavity 30 and cavity 87 of the ASD Relay connector. Turn the ignition on. Measure the voltage of the A/C Clutch Relay Control circuit. Is the voltage above 1.0 volt?  Yes → Repair the A/C Clutch Relay Control circuit for a short to voltage. Perform ROAD TEST VERIFICATION - VER-2.  No → Go To 5	All
5	If there are no possible causes remaining, view repair.  Repair Replace and program the Engine Control Module in accordance with the Service Information. Perform ROAD TEST VERIFICATION - VER-2.	All

**Symptom:**

**P0651-SENSOR REFERENCE VOLTAGE B CKT VOLTAGE TOO HIGH**

**When Monitored and Set Condition:**

**P0651-SENSOR REFERENCE VOLTAGE B CKT VOLTAGE TOO HIGH**

When Monitored: With the ignition on.

Set Condition: The ECM detects a short to voltage on the Sensor Reference Voltage B circuit or the Accelerator Pedal Position Sensor 5-Volt Supply circuit.

POSSIBLE CAUSES
INTERMITTENT CONDITION SENSOR REFERENCE VOLTAGE B CIRCUIT SHORTED TO VOLTAGE ACCELERATOR PEDAL POSITION SENSOR 5 VOLT SUPPLY CIRCUIT SHORTED TO VOLTAGE ENGINE CONTROL MODULE

TEST	ACTION	APPLICABILITY
1	Turn the ignition on. With the DRB, erase ECM DTCs. Monitor the DRB for ECM DTCs. Did this DTC set again?  Yes → Go To 2  No → Go To 5	All
2	Turn the ignition off. Disconnect the Boost Pressure Sensor harness connector. Disconnect the Engine Oil Pressure Sensor harness connector. Disconnect the A/C Pressure Sensor harness connector. Disconnect the ECM harness connectors. Remove the ASD Relay from the PDC. Connect a jumper wire between cavity 30 and cavity 87 of the ASD Relay connector. Turn the ignition on. Measure the voltage on the Sensor Reference Voltage B circuit. Is the voltage above 1.0 volt?  Yes → Repair the Sensor Reference Voltage B circuit for a short to voltage. Perform ROAD TEST VERIFICATION - VER-2.  No → Go To 3  <b>NOTE: Remove the jumper wire and reinstall the ASD Relay.</b>	All

## P0651-SENSOR REFERENCE VOLTAGE B CKT VOLTAGE TOO HIGH — Continued

TEST	ACTION	APPLICABILITY
3	Turn the ignition off. Disconnect the Accelerator Pedal Position Sensor harness connector. Disconnect the ECM harness connectors. Remove the ASD Relay from the PDC. Connect a jumper wire between cavity 30 and cavity 87 of the ASD Relay connector. Turn the ignition on. Measure the voltage on the Accelerator Pedal Position Sensor 5-Volt Supply circuit. Is the voltage below 1.0 volt?  Yes → Go To 4  No → Repair the Accelerator Pedal Position Sensor 5-Volt Supply circuit for a short to voltage. Perform ROAD TEST VERIFICATION - VER-2.  <b>NOTE: Remove the jumper wire and reinstall the ASD Relay.</b>	All
4	If there are no possible causes remaining, view repair.  Repair Replace and program the Engine Control Module in accordance with the Service Information. Perform ROAD TEST VERIFICATION - VER-2.	All
5	<b>WARNING: WHEN THE ENGINE IS OPERATING, DO NOT STAND IN A DIRECT LINE WITH THE FAN. DO NOT PUT YOUR HANDS NEAR THE PULLEYS, BELTS OR FAN. DO NOT WEAR LOOSE CLOTHING.</b> <b>NOTE: The conditions that set the DTC are not present at this time. The following list may help in identifying the intermittent condition.</b> With the engine running at normal operating temperature, monitor the DRB parameters related to the DTC while wiggling the wiring harness. Look for parameter values to change and/or a DTC to set. Review the DTC When Monitored and Set Conditions. If possible, try to duplicate the conditions under which the DTC was set. Refer to any Technical Service Bulletins (TSB) that may apply. Visually inspect the related wiring harness. Look for any chafed, pierced, pinched, or partially broken wires. Visually inspect the related wiring harness connectors. Look for broken, bent, pushed out, or corroded terminals. Were any of the above conditions present?  Yes → Repair as necessary. Perform ROAD TEST VERIFICATION - VER-2.  No → Test Complete.	All



**Symptom:**

**P0651-SENSOR REFERENCE VOLTAGE B CKT VOLTAGE TOO LOW**

---

**When Monitored and Set Condition:**

**P0651-SENSOR REFERENCE VOLTAGE B CKT VOLTAGE TOO LOW**

When Monitored: With the ignition on.

Set Condition: The ECM detects a short to ground on the Sensor Reference Voltage B circuit, or a short to ground on the Accelerator Pedal Position Sensor 5-Volt Supply circuit.

**POSSIBLE CAUSES**

INTERMITTENT CONDITION

A/C PRESS, OIL PRESS, BOOST PRESS, OR APP SENSOR SHORTED TO GROUND

SENSOR REFERENCE VOLTAGE B CIRCUIT SHORTED TO GROUND

SENSOR REFERENCE VOLTAGE B CIRCUIT SHORTED TO SENSOR GROUND

ACCELERATOR PEDAL POSITION SENSOR 5-VOLT SUPPLY CIRCUIT SHORTED TO GROUND

ACCELERATOR PEDAL POSITION SENSOR 5-VOLT SUPPLY CIRCUIT SHORTED TO SENSOR GROUND

ENGINE CONTROL MODULE

TEST	ACTION	APPLICABILITY
1	Turn the ignition on. With the DRB, erase ECM DTCs. Monitor the DRB for ECM DTCs. Did this DTC set again?  Yes → Go To 2  No → Go To 8	All

## P0651-SENSOR REFERENCE VOLTAGE B CKT VOLTAGE TOO LOW — Continued

TEST	ACTION	APPLICABILITY
2	<p>Turn the ignition on. With the DRBIII® in Sensors, monitor the Accelerator Pedal Position and Boost Pressure Sensors only. One at a time while monitoring the DRB sensor readings, disconnect then reconnect the Boost Pressure, Accelerator Pedal Position, A/C Pressure and Engine Oil Pressure Sensor harness connectors. <b>WARNING: WHEN THE ENGINE IS OPERATING, DO NOT STAND IN A DIRECT LINE WITH THE FAN. DO NOT PUT YOUR HANDS NEAR THE PULLEYS, BELTS OR FAN. DO NOT WEAR LOOSE CLOTHING.</b> Start the engine. <b>NOTE: If one of the sensors is shorted to ground internally, disconnecting it will cause the voltage reading on the DRB to rise for the monitored sensor that has not been disconnected.</b> <b>NOTE: Disconnecting components will generate new DTCs which should be ignored.</b> Did either of the monitored sensor voltage readings rise when one sensor was disconnected?</p> <p style="padding-left: 40px;">Yes → Replace the Sensor that, when disconnected, caused the DRB sensor readings to rise. Perform ROAD TEST VERIFICATION - VER-2.</p> <p style="padding-left: 40px;">No → Go To 3</p>	All
3	<p>Turn the ignition off. Disconnect the ECM harness connectors. Disconnect the Boost Pressure, A/C Pressure and Engine Oil Pressure Sensors harness connectors. Measure the resistance between ground and the Sensor Reference Voltage B circuit. Is the resistance above 100 kohms?</p> <p style="padding-left: 40px;">Yes → Go To 4</p> <p style="padding-left: 40px;">No → Repair the Sensor Reference Voltage B circuit for a short to ground. Perform ROAD TEST VERIFICATION - VER-2.</p>	All
4	<p>Turn the ignition off. Disconnect the ECM harness connectors. Disconnect the Engine Oil Pressure Sensor harness connector. Measure the resistance between the Sensor Reference Voltage B circuit and the Oil Pressure Sensor Ground circuit. Disconnect the Boost Pressure Sensor harness connector. Measure the resistance between the Sensor Reference Voltage B circuit and the Boost Pressure Sensor Ground circuit. Disconnect the A/C Pressure Sensor harness connector. Measure the resistance between the Sensor Reference Voltage B circuit and the A/C Pressure Sensor Ground circuit. Is the resistance above 100 kohms for each measurement?</p> <p style="padding-left: 40px;">Yes → Go To 5</p> <p style="padding-left: 40px;">No → Repair the Sensor Reference Voltage B circuit for a short to the Sensor Ground circuit that measured below 100 kohms. Perform ROAD TEST VERIFICATION - VER-2.</p>	All

**P0651-SENSOR REFERENCE VOLTAGE B CKT VOLTAGE TOO LOW — Continued**

TEST	ACTION	APPLICABILITY
5	Turn the ignition off. Disconnect the ECM harness connectors. Disconnect the Accelerator Pedal Position Sensor harness connector. Measure the resistance between ground and the Accelerator Pedal Position Sensor 5-Volt Supply circuit. Is the resistance above 100 kohms?  Yes → Go To 6  No → Repair the Accelerator Pedal Position Sensor 5-Volt Supply circuit for a short to ground. Perform ROAD TEST VERIFICATION - VER-2.	All
6	Turn the ignition off. Disconnect the ECM harness connectors. Disconnect the Accelerator Pedal Position Sensor harness connector. Measure the resistance between the Accelerator Pedal Position Sensor 5-Volt Supply circuit and both Sensor Ground circuits. Is the resistance above 100 kohms for each measurement?  Yes → Go To 7  No → Repair the Accelerator Pedal Position Sensor 5-Volt Supply circuit for a short to the Sensor Ground circuit. Perform ROAD TEST VERIFICATION - VER-2.	All
7	If there are no possible causes remaining, view repair.  Repair Replace and program the Engine Control Module in accordance with the Service Information. Perform ROAD TEST VERIFICATION - VER-2.	All
8	<p><b>WARNING: WHEN THE ENGINE IS OPERATING, DO NOT STAND IN A DIRECT LINE WITH THE FAN. DO NOT PUT YOUR HANDS NEAR THE PULLEYS, BELTS OR FAN. DO NOT WEAR LOOSE CLOTHING.</b></p> <p><b>NOTE: The conditions that set the DTC are not present at this time. The following list may help in identifying the intermittent condition.</b></p> With the engine running at normal operating temperature, monitor the DRB parameters related to the DTC while wiggling the wiring harness. Look for parameter values to change and/or a DTC to set. Review the DTC When Monitored and Set Conditions. If possible, try to duplicate the conditions under which the DTC was set. Refer to any Technical Service Bulletins (TSB) that may apply. Visually inspect the related wiring harness. Look for any chafed, pierced, pinched, or partially broken wires. Visually inspect the related wiring harness connectors. Look for broken, bent, pushed out, or corroded terminals. Were any of the above conditions present?  Yes → Repair as necessary. Perform ROAD TEST VERIFICATION - VER-2.  No → Test Complete.	All

**Symptom:****P0685-ASD RELAY CONTROL CIRCUIT SHUTS OFF TOO EARLY****When Monitored and Set Condition:****P0685-ASD RELAY CONTROL CIRCUIT SHUTS OFF TOO EARLY**

When Monitored: During after-run.

Set Condition: The internal ECM timer determines that the ASD Relay has shut off before the AFTER-RUN mode of operation has been completed.

**POSSIBLE CAUSES**

CHECK FOR OTHER DTCS  
 INTERMITTENT CONDITION  
 SUBSTITUTE ASD RELAY  
 ASD RELAY CONTROL CIRCUIT OPEN INTERMITTENTLY  
 ENGINE CONTROL MODULE

TEST	ACTION	APPLICABILITY
1	Turn the ignition on. With the DRB, check for additional DTCs. Are other DTCs present?  Yes → Refer to the Symptom List for diagnosis of the other DTCs before continuing. Perform ROAD TEST VERIFICATION - VER-2.  No → Go To 2	All
2	Turn the ignition on. With the DRB, erase ECM DTCs. Perform several ignition key cycles, pausing for at least 10 seconds between each cycle. Turn the ignition on. With the DRB, read ECM DTCs. Did this DTC set again?  Yes → Go To 3  No → Go To 5	All
3	Turn the ignition off. Install a substitute relay in place of the ASD Relay. Perform several ignition key cycles, pausing for at least 10 seconds between each cycle. Turn the ignition on. With the DRB, read ECM DTCs. Did this DTC set again?  Yes → Go To 4  No → Replace the ASD Relay. Perform ROAD TEST VERIFICATION - VER-2.	All

**P0685-ASD RELAY CONTROL CIRCUIT SHUTS OFF TOO EARLY — Continued**

TEST	ACTION	APPLICABILITY
4	<p>Turn the ignition off.                      Remove the ASD Relay from the PDC.                      Disconnect the ECM harness connectors.                      Measure the resistance of the ASD Relay Control circuit while wiggling the wiring harness and connectors between the ECM and the PDC.                      Was the resistance above 5.0 ohms at any time while wiggling the wiring harness and connectors?</p> <p>Yes → Repair the ASD Relay Control circuit for an intermittent open.                      Perform ROAD TEST VERIFICATION - VER-2.</p> <p>No → Replace and program the Engine Control Module in accordance with the Service Information.                      Perform ROAD TEST VERIFICATION - VER-2.</p>	All
5	<p><b>WARNING: WHEN THE ENGINE IS OPERATING, DO NOT STAND IN A DIRECT LINE WITH THE FAN. DO NOT PUT YOUR HANDS NEAR THE PULLEYS, BELTS OR FAN. DO NOT WEAR LOOSE CLOTHING.</b></p> <p><b>NOTE: The conditions that set the DTC are not present at this time. The following list may help in identifying the intermittent condition.</b></p> <p>With the engine running at normal operating temperature, monitor the DRB parameters related to the DTC while wiggling the wiring harness. Look for parameter values to change and/or a DTC to set.                      Review the DTC When Monitored and Set Conditions. If possible, try to duplicate the conditions under which the DTC was set.                      Refer to any Technical Service Bulletins (TSB) that may apply.                      Visually inspect the related wiring harness. Look for any chafed, pierced, pinched, or partially broken wires.                      Visually inspect the related wiring harness connectors. Look for broken, bent, pushed out, or corroded terminals.                      Were any of the above conditions present?</p> <p>Yes → Repair as necessary.                      Perform ROAD TEST VERIFICATION - VER-2.</p> <p>No → Test Complete.</p>	All

**Symptom:****P0685-ASD RELAY CONTROL CIRCUIT SHUTS OFF TOO LATE****When Monitored and Set Condition:****P0685-ASD RELAY CONTROL CIRCUIT SHUTS OFF TOO LATE**

When Monitored: During after-run.

Set Condition: The internal ECM timer determines that the ASD Relay remains on for more than 2.0 seconds after the ECM has turned off the ASD Relay.

**POSSIBLE CAUSES**

CHECK FOR OTHER DTCS

INTERMITTENT CONDITION

SUBSTITUTE ASD RELAY

ASD RELAY CONTROL CIRCUIT SHORTED TO GROUND INTERMITTENTLY

ASD RELAY OUTPUT CIRCUIT SHORTED TO VOLTAGE

ENGINE CONTROL MODULE

TEST	ACTION	APPLICABILITY
1	Turn the ignition on. With the DRB, check for additional DTCs. Are other DTCs present?  Yes → Refer to the Symptom List for diagnosis of the other DTCs before continuing. Perform ROAD TEST VERIFICATION - VER-2.  No → Go To 2	All
2	Turn the ignition on. With the DRB, erase ECM DTCs. Perform several ignition key cycles, pausing for at least 10 seconds between each cycle. Turn the ignition on. With the DRB, read ECM DTCs. Did this DTC set again?  Yes → Go To 3  No → Go To 6	All

**P0685-ASD RELAY CONTROL CIRCUIT SHUTS OFF TOO LATE —**  
**Continued**

TEST	ACTION	APPLICABILITY
3	Turn the ignition off. Install a substitute relay in place of the ASD Relay. Perform several ignition key cycles, pausing for at least 10 seconds between each cycle. Turn the ignition on. With the DRB, read ECM DTCs. Did this DTC set again?  Yes → Go To 4  No → Replace the ASD Relay. Perform ROAD TEST VERIFICATION - VER-2.	All
4	Turn the ignition off. Remove the ASD Relay from the PDC. Disconnect the ECM harness connectors. Measure the resistance between ground and the ASD Relay Control circuit while wiggling the wiring harness and connectors. Was the resistance below 5.0 ohms at any time while wiggling the wiring harness and connectors?  Yes → Repair the ASD Relay Control circuit for an intermittent short to ground. Perform ROAD TEST VERIFICATION - VER-2.  No → Go To 5	All
5	Turn the ignition off. Remove the ASD Relay from the PDC. Turn the ignition on. Measure the voltage of the ASD Relay Output circuit. Is the voltage below 0.5 volt?  Yes → Replace and program the Engine Control Module in accordance with the Service Information. Perform ROAD TEST VERIFICATION - VER-2.  No → Repair the ASD Relay Output circuit for a short to voltage. Perform ROAD TEST VERIFICATION - VER-2.	All
6	<p><b>WARNING: WHEN THE ENGINE IS OPERATING, DO NOT STAND IN A DIRECT LINE WITH THE FAN. DO NOT PUT YOUR HANDS NEAR THE PULLEYS, BELTS OR FAN. DO NOT WEAR LOOSE CLOTHING.</b></p> <p><b>NOTE: The conditions that set the DTC are not present at this time. The following list may help in identifying the intermittent condition.</b></p> With the engine running at normal operating temperature, monitor the DRB parameters related to the DTC while wiggling the wiring harness. Look for parameter values to change and/or a DTC to set. Review the DTC When Monitored and Set Conditions. If possible, try to duplicate the conditions under which the DTC was set. Refer to any Technical Service Bulletins (TSB) that may apply. Visually inspect the related wiring harness. Look for any chafed, pierced, pinched, or partially broken wires. Visually inspect the related wiring harness connectors. Look for broken, bent, pushed out, or corroded terminals. Were any of the above conditions present?  Yes → Repair as necessary. Perform ROAD TEST VERIFICATION - VER-2.  No → Test Complete.	All

**Symptom List:**

- P0700-TRANS CONTROL 1-2/4-5 SOLENOID CIRCUIT**
- P0700-TRANS CONTROL 2-3 SOLENOID CIRCUIT**
- P0700-TRANS CONTROL 3-4 SOLENOID CIRCUIT**
- P0700-TRANS CONTROL INTERNAL CONTROLLER**
- P0700-TRANS CONTROL MOD. PRESS SOLENOID CIRCUIT**
- P0700-TRANS CONTROL SHIFT PRESSURE SOLENOID CIRCUIT**
- P0700-TRANS CONTROL SOLENOID SUPPLY VOLTAGE**
- P0700-TRANS CONTROL TCC SOLENOID CIRCUIT**
- P0702-TRANS CONTROL ABS SENSOR MESSAGE**
- P0702-TRANS CONTROL ENGINE T-CASE SWITCH MESSAGE**
- P0702-TRANS CONTROL IMPROPER GEAR**
- P0702-TRANS CONTROL IMPROPER RATIO OR TRANSMISSION SLIPPING**
- P0702-TRANS CONTROL INTERNAL SHIFTER FAILURE**
- P0702-TRANS CONTROL N2 OR N3 INPUT SENSOR CIRCUIT**
- P0702-TRANS CONTROL TCC FAULT**

**Test Note: All symptoms listed above are diagnosed using the same tests. The title for the tests will be P0700-TRANS CONTROL 1-2/4-5 SOLENOID CIRCUIT.**

**POSSIBLE CAUSES**

VERIFY CURRENT DTC

TEST	ACTION	APPLICABILITY
1	<p><b>NOTE: If DTC P1242 is present with this DTC, perform the diagnostic for P1242 before continuing.</b></p> <p><b>NOTE: This code was set in the ECM by the Transmission Control Module to indicate a transmission fault. Diagnosis of transmission faults should be done using the Transmission Diagnostic Information.</b></p> <p><b>NOTE: When repairs have been completed, the ECM and TCM must have codes cleared.</b></p> <p>Turn the ignition on.</p> <p>With the DRBIII®, erase ECM DTCs only.</p> <p>With the DRBIII®, read ECM DTCs.</p> <p>Are any P0700 or P0702 DTCs present in the ECM?</p> <p style="padding-left: 40px;">Yes → Refer to Transmission Diagnostic Information for the related symptom(s). Perform W5J400 TRANSMISSION VERIFICATION TEST - VER 1.</p> <p style="padding-left: 40px;">No → Test Complete.</p>	All



**Symptom List:**

**P0703-BRAKE SWITCH SIGNAL CIRCUITS PLAUSIBILITY WITH REDUNDANT CONTACT**

**P0703-BRAKE SWITCH SIGNAL CKTS PLAUS W/REDUNDANT CONTACT AFTER INITIALIZATION**

---

**Test Note: All symptoms listed above are diagnosed using the same tests. The title for the tests will be P0703-BRAKE SWITCH SIGNAL CIRCUITS PLAUSIBILITY WITH REDUNDANT CONTACT.**

---

**When Monitored and Set Condition:**

**P0703-BRAKE SWITCH SIGNAL CIRCUITS PLAUSIBILITY WITH REDUNDANT CONTACT**

When Monitored: With the ignition on.

Set Condition: The ECM detects the Primary Brake Switch Signal circuit and Secondary Brake Switch Signal circuit inputs to the ECM do not agree.

**P0703-BRAKE SWITCH SIGNAL CKTS PLAUS W/REDUNDANT CONTACT AFTER INITIALIZATION**

When Monitored: With the ignition on.

Set Condition: The ECM detects the Primary Brake Switch Signal circuit and Secondary Brake Switch Signal circuit inputs to the ECM do not agree.

---

**POSSIBLE CAUSES**

INTERMITTENT CONDITION

BRAKE LAMP SWITCH - SECONDARY OPEN

BRAKE LAMP SWITCH FUSED B+ CIRCUIT OPEN

SECONDARY BRAKE SWITCH SIGNAL CIRCUIT SHORTED TO GROUND

BRAKE LAMP SWITCH - PRIMARY OPEN

SECONDARY BRAKE SWITCH GROUND CIRCUIT OPEN

SECONDARY BRAKE SWITCH SIGNAL CIRCUIT OPEN

PRIMARY BRAKE SWITCH SIGNAL CIRCUIT SHORTED TO VOLTAGE

PRIMARY BRAKE SWITCH SIGNAL CIRCUIT OPEN

ENGINE CONTROL MODULE - INTERNAL

ENGINE CONTROL MODULE - PRIMARY BRAKE SIGNAL

ENGINE CONTROL MODULE - SECONDARY BRAKE SIGNAL

---

## P0703-BRAKE SWITCH SIGNAL CIRCUITS PLAUSIBILITY WITH REDUNDANT CONTACT — Continued

TEST	ACTION	APPLICABILITY
1	Turn the ignition on. While observing the PRIM BRAKE SWITCH status on the DRB display, press and release the brake pedal several times. Does the DRB display PRIM BRAKE SWITCH: PRESSED and RELEASED for the appropriate pedal position?  Yes → Go To 2 No → Go To 11	All
2	Turn the ignition on. While observing the SEC BRAKE SWITCH status on the DRB display, press and release the brake pedal several times. Does the DRB display SEC BRAKE SWITCH: PRESSED and RELEASED for the appropriate pedal position?  Yes → Go To 3 No → Go To 4	All
3	<b>WARNING: WHEN THE ENGINE IS OPERATING, DO NOT STAND IN A DIRECT LINE WITH THE FAN. DO NOT PUT YOUR HANDS NEAR THE PULLEYS, BELTS OR FAN. DO NOT WEAR LOOSE CLOTHING.</b> <b>NOTE: The conditions that set the DTC are not present at this time. The following list may help in identifying the intermittent condition.</b> With the engine running at normal operating temperature, monitor the DRB parameters related to the DTC while wiggling the wiring harness. Look for parameter values to change and/or a DTC to set. Review the DTC When Monitored and Set Conditions. If possible, try to duplicate the conditions under which the DTC was set. Refer to any Technical Service Bulletins (TSB) that may apply. Visually inspect the related wiring harness. Look for any chafed, pierced, pinched, or partially broken wires. Visually inspect the related wiring harness connectors. Look for broken, bent, pushed out, or corroded terminals. Were any of the above conditions present?  Yes → Repair as necessary. Perform ROAD TEST VERIFICATION - VER-2.  No → Test Complete.	All
4	Turn the ignition off. Disconnect the Brake Lamp Switch harness connector. Turn the ignition on. Measure the voltage between the Secondary Brake Switch Signal circuit and ground. Is the voltage above 9.0 volts?  Yes → Go To 5 No → Go To 8	All

**P0703-BRAKE SWITCH SIGNAL CIRCUITS PLAUSIBILITY WITH REDUNDANT CONTACT — Continued**

TEST	ACTION	APPLICABILITY
5	Disconnect the Brake Lamp Switch harness connector. Turn the ignition on. While monitoring the SEC BRAKE SWITCH status with the DRB, connect a jumper wire between ground and the Secondary Brake Switch Signal circuit. Does the DRB display change from PRESSED to RELEASED?  Yes → Adjust or replace the Brake Lamp Switch in accordance with the Service Information. Perform ROAD TEST VERIFICATION - VER-2.  No → Go To 6	All
6	Turn the ignition off. Disconnect the Brake Lamp Switch harness connector. Measure the resistance between ground and the Secondary Brake Switch Ground circuit. Is the resistance below 10.0 ohms?  Yes → Go To 7  No → Repair the Secondary Brake Switch Ground circuit for an open. Perform ROAD TEST VERIFICATION - VER-2.	All
7	If there are no possible causes remaining, view repair.  Repair Replace and program the Engine Control Module in accordance with the Service Information. Perform ROAD TEST VERIFICATION - VER-2.	All
8	Turn the ignition off. Disconnect the Brake Lamp Switch harness connector. Disconnect the ECM harness connectors. Measure the resistance between ground and the Secondary Brake Switch Signal circuit. Is the resistance above 1000 ohms?  Yes → Go To 9  No → Repair the Secondary Brake Switch Signal circuit for a short to ground. Perform ROAD TEST VERIFICATION - VER-2.	All
9	Turn the ignition off. Disconnect the Brake Lamp Switch harness connector. Disconnect the ECM harness connectors. Measure the resistance of the Secondary Brake Switch Signal circuit. Is the resistance below 10.0 ohms?  Yes → Go To 10  No → Repair the Secondary Brake Switch Signal circuit for an open. Perform ROAD TEST VERIFICATION - VER-2.	All
10	If there are no possible causes remaining, view repair.  Repair Replace and program the Engine Control Module in accordance with the Service Information. Perform ROAD TEST VERIFICATION - VER-2.	All

## P0703-BRAKE SWITCH SIGNAL CIRCUITS PLAUSIBILITY WITH REDUNDANT CONTACT — Continued

TEST	ACTION	APPLICABILITY
11	Disconnect the Brake Lamp Switch harness connector. Using a 12-volt test light connected to ground, check the Fused B+ circuit. Does the test light illuminate brightly?  Yes → Go To 12  No → Repair the Brake Lamp Switch Fused B+ circuit for an open. Perform ROAD TEST VERIFICATION - VER-2.	All
12	Disconnect the Brake Lamp Switch harness connector. Turn the ignition on. While monitoring the PRIM BRAKE SWITCH status with the DRB, connect a jumper wire between the Primary Brake Switch Signal circuit and the Fused B(+) circuit. Does the DRB display change from RELEASED to PRESSED?  Yes → Adjust or replace the Brake Lamp Switch in accordance with the Service Information. Perform ROAD TEST VERIFICATION - VER-2.  No → Go To 13	All
13	Turn the ignition off. Disconnect the Brake Lamp Switch harness connector. Disconnect the ECM harness connectors. Remove the ASD Relay from the PDC. Connect a jumper wire between cavity 30 and cavity 87 of the ASD Relay connector. Turn the ignition on. Measure the voltage between the Primary Brake Switch Signal circuit and ground. Is the voltage above 1.0 volt?  Yes → Repair the Primary Brake Switch Signal circuit for a short to voltage. Perform ROAD TEST VERIFICATION - VER-2.  No → Go To 14	All
14	Turn the ignition off. Disconnect the Brake Lamp Switch harness connector. Disconnect the ECM harness connectors. Measure the resistance of the Primary Brake Switch Signal circuit. Is the resistance below 5.0 ohms?  Yes → Replace and program the Engine Control Module in accordance with the Service Information. Perform ROAD TEST VERIFICATION - VER-2.  No → Repair the Primary Brake Switch Signal circuit for an open. Perform ROAD TEST VERIFICATION - VER-2.	All

**Symptom List:**

**P0836-TRANSFER CASE POSITION SENSOR PLAUSIBILITY**  
**P0836-TRANSFER CASE POSITION SENSOR PLAUSIBILITY 2**  
**P0836-TRANSFER CASE POSITION SENSOR SIGNAL VOLTAGE TOO HIGH**  
**P0836-TRANSFER CASE POSITION SENSOR SIGNAL VOLTAGE TOO LOW**

---

**Test Note: All symptoms listed above are diagnosed using the same tests. The title for the tests will be P0836-TRANSFER CASE POSITION SENSOR PLAUSIBILITY.**

---

**When Monitored and Set Condition:**

**P0836-TRANSFER CASE POSITION SENSOR PLAUSIBILITY**

When Monitored: When the ECM detects the transfer case in 4WD low.

Set Condition: The ECM detects a vehicle speed that is higher than is possible in 4WD low.

**P0836-TRANSFER CASE POSITION SENSOR PLAUSIBILITY 2**

When Monitored: With the ignition on.

Set Condition: The ECM detects a voltage signal from the transfer case switch that does not fall into a valid switch position voltage range.

**P0836-TRANSFER CASE POSITION SENSOR SIGNAL VOLTAGE TOO HIGH**

When Monitored: With the ignition on.

Set Condition: The Transfer Case Position Sensor Signal circuit voltage is above 3.0 volts.

**P0836-TRANSFER CASE POSITION SENSOR SIGNAL VOLTAGE TOO LOW**

When Monitored: With the ignition on.

Set Condition: The Transfer Case Position Sensor Signal circuit voltage is below 0.12 volt.

---

**POSSIBLE CAUSES**

CHECKING THE TRANSFER CASE POSITION SENSOR  
INTERMITTENT WIRING AND CONNECTORS  
TRANSFER CASE POSITION SENSOR SIGNAL CIRCUIT OPEN  
TRANSFER CASE POSITION SENSOR SIGNAL CIRCUIT SHORT TO GROUND  
TRANSFER CASE POSITION SENSOR SIGNAL CIRCUIT SHORT TO VOLTAGE

**P0836-TRANSFER CASE POSITION SENSOR PLAUSIBILITY — Continued****POSSIBLE CAUSES**

TRANSFER CASE POSITION SENSOR SIGNAL CIRCUIT SHORT TO SENSOR GROUND CIRCUIT

ENGINE CONTROL MODULE

TEST	ACTION	APPLICABILITY
1	With the DRBIII®, record and erase DTCs. Start the engine and cycle the Transfer Case through all positions. With the DRBIII®, read the ECM DTCs. Does the DRBIII® display this DTC?  Yes → Go To 2  No → Go To 7	All
2	Turn the ignition off to the lock position. Disconnect the ECM harness connectors. Disconnect the Transfer Case Position Sensor harness connector. Remove the ASD Relay. Connect a jumper wire between cavities 30 and 87 of the ASD Relay connector in the PDC. Turn the ignition on. Measure the voltage of the Transfer Case Position Sensor Signal circuit. Is the voltage above 1.0 volt?  Yes → Repair the Transfer Case Position Sensor Signal circuit for a short to voltage. Perform ROAD TEST VERIFICATION - VER-2.  No → Go To 3	All
3	Turn the ignition off to the lock position. Disconnect the ECM harness connectors. Disconnect the Transfer Case Position Sensor harness connector. Measure the resistance of the Transfer Case Position Sensor Signal circuit. Is the resistance below 10.0 ohms?  Yes → Go To 4  No → Repair the Transfer Case Position Sensor Signal circuit for an open. Perform ROAD TEST VERIFICATION - VER-2.	All
4	Turn the ignition off to the lock position. Disconnect the ECM harness connectors. Disconnect the Transfer Case Position Sensor harness connector. Measure the resistance between ground and the Transfer Case Position Sensor Signal circuit. Is the resistance below 1000.0 ohms?  Yes → Repair the Transfer Case Position Sensor Signal circuit for a short to ground. Perform ROAD TEST VERIFICATION - VER-2.  No → Go To 5	All

**P0836-TRANSFER CASE POSITION SENSOR PLAUSIBILITY — Continued**

TEST	ACTION	APPLICABILITY
5	Turn the ignition off to the lock position. Disconnect the ECM harness connectors. Disconnect the Transfer Case Position Sensor harness connector. Measure the resistance between the Transfer Case Position Sensor circuit and the Sensor Ground circuit. Is the resistance below 1000.0 ohms?  Yes → Repair the Transfer Case Position Sensor Signal circuit for a short to the Sensor Ground circuit. Perform ROAD TEST VERIFICATION - VER-2.  No → Go To 6	All
6	Turn the ignition on. With the DRBIII® read the T-case Sensor Observe the T-case volts on the DRB while moving the transfer case selector lever in each of the transfer case positions. <b>NOTE: When shifting the transfer case selector to each position, the Sensor voltage should result in the following voltages: 4WD Low 0.16 - 0.40, Neutral 0.68 - 0.97 4WD Full Time 1.24 - 1.55.</b> Does each position provide the correct voltage?  Yes → Replace and program the ECM in accordance with the Service Information. Perform ROAD TEST VERIFICATION - VER-2.  No → Replace the Transfer Case Position Sensor. Perform ROAD TEST VERIFICATION - VER-2.	All
7	The conditions necessary to set this DTC are not present at this time. Using the schematics as a guide, inspect the wiring and connectors specific to this circuit. Wiggle the wiring while checking for shorts and open circuits. Were there any problems found?  Yes → Repair as necessary. Perform ROAD TEST VERIFICATION - VER-2.  No → Test Complete.	All

**Symptom:**

**P0850-P/N SWITCH PLAUSIBILITY**

**When Monitored and Set Condition:**

**P0850-P/N SWITCH PLAUSIBILITY**

When Monitored: With the engine running at >3700 RPM, accelerator pedal position sensor >70%, fuel quantity >60 mm<sup>3</sup>, and the transmission physically not in Park or Neutral.

Set Condition: The ECM receives a P/N Switch input of Neutral or Park.

**POSSIBLE CAUSES**

CHECKING THE P/N SENSE CIRCUIT  
 ENGINE CONTROL MODULE  
 P/N SENSE CIRCUIT SHORTED TO VOLTAGE  
 P/N SWITCH SENSE CIRCUIT OPEN  
 P/N SWITCH SENSE CIRCUIT SHORTED TO GROUND  
 INTERMITTENT CONDITION

TEST	ACTION	APPLICABILITY
1	With the DRBIII®, record and erase DTCs. Test drive the vehicle. With the DRBIII®, read the ECM DTCs. Does the DRBIII® display this DTC?  Yes → Go To 2  No → Go To 6	All
2	Turn the ignition off. Disconnect the TCM harness connector. Turn the ignition on. With the DRBIII® in Engine Inputs/Outputs, read the P/N Switch state. Connect one end of a jumper wire to the P/N Switch Sense circuit at the TCM harness connector. Connect the other end of the jumper to ground for 10 seconds then disconnect from ground. Does the DRB Switch state change when connecting and disconnecting from ground?  Yes → The Park/Neutral Position Sense circuitry is operating properly. Refer to Transmission Diagnostic information for the related symptom(s). Perform ROAD TEST VERIFICATION - VER-2.  No → Go To 3	All



**P0850-P/N SWITCH PLAUSIBILITY — Continued**

TEST	ACTION	APPLICABILITY
3	<p>Turn the ignition off.                      Disconnect the TCM harness connector.                      Disconnect the ECM harness connectors.                      Remove the ASD Relay from the PDC.                      Connect a jumper wire between cavities 30 and 87 in the ASD connector in the PDC.                      Turn the ignition on.                      Measure the voltage of the P/N Switch Sense circuit.                      Is the voltage above 1.0 volt?</p> <p>Yes → Repair the Park/Neutral Switch Sense circuit for a short to voltage.                      Perform ROAD TEST VERIFICATION - VER-2.</p> <p>No → Go To 4</p>	All
4	<p>Turn the ignition off.                      Disconnect the TCM harness connector.                      Disconnect the ECM harness connectors.                      Measure the resistance of the P/N Switch Sense circuit.                      Is the resistance below 10.0 ohms?</p> <p>Yes → Go To 5</p> <p>No → Repair the Park/Neutral Position Sense circuit for an open.                      Perform ROAD TEST VERIFICATION - VER-2.</p>	All
5	<p>Turn the ignition off.                      Disconnect the TCM harness connector.                      Disconnect the ECM harness connectors.                      Measure the resistance between ground and the P/N Switch Sense circuit.                      Is the resistance above 1000.0 ohms?</p> <p>Yes → Replace and program the Engine Control Module in accordance with the Service Information.                      Perform ROAD TEST VERIFICATION - VER-2.</p> <p>No → Repair the P/N Switch Sense circuit for a short to ground.                      Perform ROAD TEST VERIFICATION - VER-2.</p>	All
6	<p><b>WARNING: WHEN THE ENGINE IS OPERATING, DO NOT STAND IN A DIRECT LINE WITH THE FAN. DO NOT PUT YOUR HANDS NEAR THE PULLEYS, BELTS OR FAN. DO NOT WEAR LOOSE CLOTHING.</b></p> <p><b>NOTE: The conditions that set the DTC are not present at this time. The following list may help in identifying the intermittent condition.</b></p> <p>With the engine running at normal operating temperature, monitor the DRB parameters related to the DTC while wiggling the wiring harness. Look for parameter values to change and/or a DTC to set.                      Review the DTC When Monitored and Set Conditions. If possible, try to duplicate the conditions under which the DTC was set.                      Refer to any Technical Service Bulletins (TSB) that may apply.                      Visually inspect the related wiring harness. Look for any chafed, pierced, pinched, or partially broken wires.                      Visually inspect the related wiring harness connectors. Look for broken, bent, pushed out, or corroded terminals.                      Were any of the above conditions present?</p> <p>Yes → Repair as necessary.                      Perform ROAD TEST VERIFICATION - VER-2.</p> <p>No → Test Complete.</p>	All

**Symptom List:**

**P1130-FUEL RAIL PRESSURE MALFUNCTION ACTUATOR STICKING**

**P1130-FUEL RAIL PRESSURE MALFUNCTION LEAKAGE DETECTED**

**P1130-FUEL RAIL PRESSURE MALFUNCTION POSITIVE DEVIATION**

**P1130-FUEL RAIL PRESSURE MALFUNCTION PRESSURE TOO HIGH-SHUT OFF**

**P1130-FUEL RAIL PRESSURE MALFUNCTION PRESSURE TOO LOW**

**P1130-FUEL RAIL PRESSURE MALFUNCTION SOLENOID OPEN**

---

**Test Note: All symptoms listed above are diagnosed using the same tests. The title for the tests will be P1130-FUEL RAIL PRESSURE MALFUNCTION ACTUATOR STICKING.**

---

**When Monitored and Set Condition:**

**P1130-FUEL RAIL PRESSURE MALFUNCTION ACTUATOR STICKING**

When Monitored: With the engine speed above 730 rpm.

Set Condition: The fuel rail pressure sensor indicates fuel pressure above what the ECM commanded.

**P1130-FUEL RAIL PRESSURE MALFUNCTION LEAKAGE DETECTED**

When Monitored: With the engine speed above 730 rpm.

Set Condition:

**P1130-FUEL RAIL PRESSURE MALFUNCTION POSITIVE DEVIATION**

When Monitored: With the engine speed above 730 rpm.

Set Condition: The ECM commands the fuel pressure solenoid and the fuel pressure sensor indicates a fuel pressure reading less than what is expected by the ECM based on the ECM command to the fuel pressure solenoid.

**P1130-FUEL RAIL PRESSURE MALFUNCTION PRESSURE TOO HIGH-SHUT OFF**

When Monitored: With the engine speed above 730 rpm.

Set Condition: The fuel rail pressure sensor indicates fuel pressure above 21,000 PSI with the engine off.

**P1130-FUEL RAIL PRESSURE MALFUNCTION ACTUATOR STICKING — Continued**

**P1130-FUEL RAIL PRESSURE MALFUNCTION PRESSURE TOO LOW**

When Monitored: With the engine running.

Set Condition: The ECM determines that the fuel rail pressure is too low for a given engine speed.

**P1130-FUEL RAIL PRESSURE MALFUNCTION SOLENOID OPEN**

When Monitored: With the engine running.

Set Condition: The ECM detects a higher rate of fuel pressure than the target pressure.

**POSSIBLE CAUSES**

- CHECKING FOR OTHER DTC'S
- CHECKING THE FUEL PRESSURE
- FUEL INJECTOR CONTROL CIRCUIT SHORTED TO GROUND
- FUEL PRESSURE SENSOR
- FUEL SYSTEM LEAK
- INJECTOR COMMON DRIVER CIRCUIT OPEN
- INTERMITTENT CONDITION

TEST	ACTION	APPLICABILITY
1	<p><b>WARNING: THE FUEL INJECTION PUMP SUPPLIES HIGH-PRESSURE FUEL TO EACH INDIVIDUAL INJECTOR THROUGH HIGH-PRESSURE FUEL LINES. FUEL UNDER HIGH PRESSURE CAN PENETRATE SKIN AND CAUSE PERSONAL INJURY. WEAR SAFETY GOGGLES AND ADE-QUATE PROTECTIVE CLOTHING.</b></p> <p>Turn the ignition on.                      With the DRBIII®, read the ECM DTCs.                      Are there any other DTCs present?</p> <p style="padding-left: 40px;">Yes → Refer to symptom list for problems related to the DTC other than P1130.                      Perform ROAD TEST VERIFICATION - VER-2.</p> <p style="padding-left: 40px;">No → Go To 2</p>	All
2	<p>Turn the ignition on.                      With the DRBIII®, erase the ECM DTCs.                      Test drive the vehicle under various load and speed conditions to attempt to duplicate the fault.                      With the DRBIII®, read the ECM DTCs.                      Does the DRBIII® display this DTC?</p> <p style="padding-left: 40px;">Yes → Go To 3</p> <p style="padding-left: 40px;">No → Go To 7</p>	All

## P1130-FUEL RAIL PRESSURE MALFUNCTION ACTUATOR STICKING — Continued

TEST	ACTION	APPLICABILITY
3	Turn the ignition off. Inspect the entire fuel system for leakage. Is there any evidence of leakage?  Yes → Repair as necessary in accordance with the Service Information. Perform ROAD TEST VERIFICATION - VER-2.  No → Go To 4	All
4	Turn the ignition off. Disconnect the ECM harness connectors. Disconnect all of the Fuel Injector harness connectors. Measure the resistance between ground and each of the Fuel Injector Control circuits. Is the resistance below 1000 ohms for any of the measurements?  Yes → Repair the appropriate Fuel Injector Control circuit for a short to ground. Perform ROAD TEST VERIFICATION - VER-2.  No → Go To 5	All
5	Turn the ignition off. Disconnect the ECM harness connectors. Disconnect all of the Fuel Injector harness connectors. Measure the resistance of the Common Injector Driver circuit between the ECM harness connector and each Fuel Injector harness connector. Is the resistance below 10.0 ohms for each measurement?  Yes → Go To 6  No → Repair the Injector Common Driver circuit for an open. Perform ROAD TEST VERIFICATION - VER-2.	All
6	Refer to the appropriate Service Information and perform the Fuel Pressure Test. <b>NOTE: The following is a list of problems that can cause the fuel pressure to become out of specification: restricted fuel filter or fuel lines, failed fuel pressure solenoid, air in fuel system, failed fuel sending unit, gelled fuel, faulty injector.</b> Is the fuel pressure within specification?  Yes → Replace the Fuel Pressure Sensor in accordance with the Service Information. Perform ROAD TEST VERIFICATION - VER-2.  No → Repair as necessary in accordance with the Service Information. Perform ROAD TEST VERIFICATION - VER-2.	All

**P1130-FUEL RAIL PRESSURE MALFUNCTION ACTUATOR STICKING —  
Continued**

TEST	ACTION	APPLICABILITY
7	<p><b>WARNING: WHEN THE ENGINE IS OPERATING, DO NOT STAND IN A DIRECT LINE WITH THE FAN. DO NOT PUT YOUR HANDS NEAR THE PULLEYS, BELTS OR FAN. DO NOT WEAR LOOSE CLOTHING.</b></p> <p><b>NOTE: The conditions that set the DTC are not present at this time. The following list may help in identifying the intermittent condition.</b></p> <p>With the engine running and at normal operating temperature, monitor the DRB parameters related to the DTC while wiggling the wiring harness. Look for parameter values to change and/or a DTC to set.</p> <p>Review the DTC When Monitored and Set Conditions. If possible, try to duplicate the conditions under which the DTC was set.</p> <p>Refer to any Technical Service Bulletins (TSB) that may apply.</p> <p>Visually inspect the related wiring harness. Look for any chafed, pierced, pinched, or partially broken wires.</p> <p>Visually inspect the related wiring harness connectors. Look for broken, bent, pushed out, or corroded terminals.</p> <p>Were any of the above conditions present?</p> <p style="padding-left: 40px;">Yes → Repair as necessary. Perform ROAD TEST VERIFICATION - VER-2.</p> <p style="padding-left: 40px;">No → Test Complete.</p>	All

**Symptom List:**

**P1131-FUEL PRESSURE SOLENOID OPEN CIRCUIT**  
**P1131-FUEL PRESSURE SOLENOID POWERSTAGE ERROR**  
**P1131-FUEL PRESSURE SOLENOID SHORT CIRCUIT**

**Test Note: All symptoms listed above are diagnosed using the same tests. The title for the tests will be P1131-FUEL PRESSURE SOLENOID OPEN CIRCUIT.**

**When Monitored and Set Condition:****P1131-FUEL PRESSURE SOLENOID OPEN CIRCUIT**

When Monitored: With the ignition on.

Set Condition: The ECM detects an open or short to ground on the Fuel Pressure Solenoid Control circuit.

**P1131-FUEL PRESSURE SOLENOID POWERSTAGE ERROR**

When Monitored: When the ignition is turned off.

Set Condition: The ECM detects engine speed does not fall below 650 RPM within 1.5 second after ignition off.

**P1131-FUEL PRESSURE SOLENOID SHORT CIRCUIT**

When Monitored: With the ignition on.

Set Condition: The ECM detects a short to voltage on the Fuel Pressure Solenoid Control circuit.

**POSSIBLE CAUSES**

INTERMITTENT CONDITION

ASD RELAY OUTPUT CIRCUIT OPEN

FUEL PRESSURE SOLENOID CONTROL SHORTED TO VOLTAGE

FUEL PRESSURE SOLENOID CONTROL CIRCUIT SHORTED TO GROUND

FUEL PRESSURE SOLENOID CONTROL CIRCUIT OPEN

FUEL PRESSURE SOLENOID

ENGINE CONTROL MODULE

**P1131-FUEL PRESSURE SOLENOID OPEN CIRCUIT — Continued**

TEST	ACTION	APPLICABILITY
1	<p><b>WARNING: THE FUEL INJECTION PUMP SUPPLIES HIGH-PRESSURE FUEL TO EACH INDIVIDUAL INJECTOR THROUGH HIGH-PRESSURE FUEL LINES. FUEL UNDER HIGH PRESSURE CAN PENETRATE SKIN AND CAUSE PERSONAL INJURY. WEAR SAFETY GOGGLES AND ADEQUATE PROTECTIVE CLOTHING.</b></p> <p>Turn the ignition on.                      With the DRB, erase ECM DTCs.                      Start the engine several times, turning the ignition off for at least 30 seconds between each run cycle.                      Monitor the DRB for ECM DTCs.                      Did this DTC set again?</p> <p>Yes → Go To 2                      No → Go To 8</p>	All
2	<p>Turn the ignition off.                      Disconnect the Fuel Pressure Solenoid harness connector.                      Turn the ignition on.                      Using a 12-volt test light connected to ground, check the ASD Relay Output circuit.                      Does the test light illuminate brightly?</p> <p>Yes → Go To 3                      No → Repair the ASD Relay Output circuit for an open.                      Perform ROAD TEST VERIFICATION - VER-2.</p>	All
3	<p>Turn the ignition off.                      Disconnect the Fuel Pressure Solenoid harness connector.                      Disconnect the ECM harness connectors.                      Remove the ASD Relay from the PDC.                      Connect a jumper wire between cavity 30 and cavity 87 of the ASD Relay connector.                      Turn the ignition on.                      Measure the voltage of the Fuel Pressure Solenoid Control circuit.                      Is the voltage below 1.0 volt?</p> <p>Yes → Go To 4                      No → Repair the Fuel Pressure Solenoid Control circuit for a short to voltage.                      Perform ROAD TEST VERIFICATION - VER-2.</p>	All
4	<p>Turn the ignition off.                      Disconnect the Fuel Pressure Solenoid harness connector.                      Disconnect the ECM harness connectors.                      Measure the resistance between ground and the Fuel Pressure Solenoid Control circuit.  <b>NOTE: The Fuel Pressure Solenoid Control circuit is duplicated at ECM cavities C2-80 and C2-81.</b>                      Is the resistance above 100 kohms?</p> <p>Yes → Go To 5                      No → Repair the Fuel Pressure Solenoid Control circuit for a short to ground.                      Perform ROAD TEST VERIFICATION - VER-2.</p>	All

**P1131-FUEL PRESSURE SOLENOID OPEN CIRCUIT — Continued**

TEST	ACTION	APPLICABILITY
5	Turn the ignition off. Disconnect the Fuel Pressure Solenoid harness connector. Disconnect the ECM harness connectors. Measure the resistance of the Fuel Pressure Solenoid Control circuit. <b>NOTE: The Fuel Pressure Solenoid Control circuit is duplicated at ECM cavities C1-80 and C1-81.</b> Is the resistance below 5.0 ohms?  Yes → Go To 6  No → Repair the Fuel Pressure Solenoid Control circuit for an open. Perform ROAD TEST VERIFICATION - VER-2.	All
6	Turn the ignition off. Disconnect the Fuel Pressure Solenoid harness connector. Turn the ignition on. With the DRB, erase ECM DTCs. Monitor the DRB for ECM DTCs. <b>NOTE: The DRB should display P1131-FUEL PRESSURE SOLENOID OPEN CIRCUIT.</b> Turn the ignition off. Connect a jumper wire between cavity 1 and cavity 2 of the Fuel Pressure Solenoid harness connector. Turn the ignition on. With the DRB, erase ECM DTCs. Monitor the DRB for ECM DTCs. <b>NOTE: The DRB should display P1131-FUEL PRESSURE SOLENOID SHORT CIRCUIT.</b> Does the DRB display the appropriate DTC for each condition?  Yes → Replace the Fuel Pressure Solenoid in accordance with the Service Information. Perform ROAD TEST VERIFICATION - VER-2.  No → Go To 7	All
7	If there are no possible causes remaining, view repair.  Repair Replace and program the Engine Control Module in accordance with the Service Information. Perform ROAD TEST VERIFICATION - VER-2.	All



**P1131-FUEL PRESSURE SOLENOID OPEN CIRCUIT — Continued**

TEST	ACTION	APPLICABILITY
8	<p><b>WARNING: WHEN THE ENGINE IS OPERATING, DO NOT STAND IN A DIRECT LINE WITH THE FAN. DO NOT PUT YOUR HANDS NEAR THE PULLEYS, BELTS OR FAN. DO NOT WEAR LOOSE CLOTHING.</b></p> <p><b>NOTE: The conditions that set the DTC are not present at this time. The following list may help in identifying the intermittent condition.</b></p> <p>With the engine running at normal operating temperature, monitor the DRB parameters related to the DTC while wiggling the wiring harness. Look for parameter values to change and/or a DTC to set.</p> <p>Review the DTC When Monitored and Set Conditions. If possible, try to duplicate the conditions under which the DTC was set.</p> <p>Refer to any Technical Service Bulletins (TSB) that may apply.</p> <p>Visually inspect the related wiring harness. Look for any chafed, pierced, pinched, or partially broken wires.</p> <p>Visually inspect the related wiring harness connectors. Look for broken, bent, pushed out, or corroded terminals.</p> <p>Were any of the above conditions present?</p> <p style="padding-left: 40px;">Yes → Repair as necessary. Perform ROAD TEST VERIFICATION - VER-2.</p> <p style="padding-left: 40px;">No → Test Complete.</p>	All

**Symptom List:**

**P1205-INJECTOR CLASSIFICATION ERROR**

**P1205-INJECTOR CLASSIFICATION ERROR CHECKSUM ERROR**

**Test Note: All symptoms listed above are diagnosed using the same tests. The title for the tests will be P1205-INJECTOR CLASSIFICATION ERROR.**

**POSSIBLE CAUSES**

ECM

VERIFY INJECTOR CLASSIFICATIONS

TEST	ACTION	APPLICABILITY
1	Turn the ignition on. With the DRBIII® check for the correct classification of all of the Fuel Injectors. Are all of the injectors classified correctly?  Yes → Replace and program the Engine Control Module in accordance with the Service Information. Perform ROAD TEST VERIFICATION - VER-2.  No → Program the Engine Control Module with the correct Injector Classification in accordance with the Service Information. Perform ROAD TEST VERIFICATION - VER-2.	All

**Symptom List:**

- P1235-EXTERNAL FUEL QUANTITY BIT ERROR**
- P1235-EXTERNAL FUEL QUANTITY DEMAND ERROR**
- P1235-EXTERNAL FUEL QUANTITY PARITY ERROR**
- P1235-EXTERNAL FUEL QUANTITY TORQUE ERROR**

**Test Note: All symptoms listed above are diagnosed using the same tests. The title for the tests will be P1235-EXTERNAL FUEL QUANTITY BIT ERROR.**

**POSSIBLE CAUSES**

CHECKING FOR TRANSMISSION CONTROL MODULE DTC'S  
 TRANSMISSION CONTROL MODULE  
 INTERMITTENT CONDITION

TEST	ACTION	APPLICABILITY
1	Turn the ignition on. With the DRBIII®, read the TCM DTCs. Are there any TCM DTC's?  Yes → Refer to symptom list for problems related to TCM DTC's. Perform ROAD TEST VERIFICATION - VER-2.  No → Go To 2	All
2	<b>NOTE: This DTC indicates a communication problem between the TCM and the ECM.</b> Turn the ignition on. With the DRB, erase ECM DTCs. Perform several engine run cycles, turning the ignition off for at least 20 seconds between each engine run cycle. With the DRBIII®, read the ECM DTCs. Did this DTC set again?  Yes → Go To 3  No → Go To 4	All
3	Turn the ignition off. Replace and program the Transmission Control Module in accordance with the Service Information. Turn the ignition on. With the DRB, erase all ECM and TCM DTC's. Perform several engine run cycles, turning the engine off for at least 20 seconds between each cycle. With the DRBIII®, read the ECM DTCs. Does the DRBIII® display this DTC?  Yes → Replace and program the Engine Control Module in accordance with the Service Information. Perform ROAD TEST VERIFICATION - VER-2.  No → Test Complete.	All

**P1235-EXTERNAL FUEL QUANTITY BIT ERROR — Continued**

TEST	ACTION	APPLICABILITY
4	<p><b>WARNING: WHEN THE ENGINE IS OPERATING, DO NOT STAND IN A DIRECT LINE WITH THE FAN. DO NOT PUT YOUR HANDS NEAR THE PULLEYS, BELTS OR FAN. DO NOT WEAR LOOSE CLOTHING.</b></p> <p><b>NOTE: The conditions that set the DTC are not present at this time. The following list may help in identifying the intermittent condition.</b></p> <p>With the engine running at normal operating temperature, monitor the DRB parameters related to the DTC while wiggling the wiring harness. Look for parameter values to change and/or a DTC to set.</p> <p>Review the DTC When Monitored and Set Conditions. If possible, try to duplicate the conditions under which the DTC was set.</p> <p>Refer to any Technical Service Bulletins (TSB) that may apply.</p> <p>Visually inspect the related wiring harness. Look for any chafed, pierced, pinched, or partially broken wires.</p> <p>Visually inspect the related wiring harness connectors. Look for broken, bent, pushed out, or corroded terminals.</p> <p>Were any of the above conditions present?</p> <p>Yes → Repair as necessary. Perform ROAD TEST VERIFICATION - VER-2.</p> <p>No → Test Complete.</p>	All

**Symptom List:**

**P1242-CAN BUS MESSAGE MISSING**

**P1242-CAN BUS MESSAGE MISSING FROM TCM**

**Test Note: All symptoms listed above are diagnosed using the same tests. The title for the tests will be P1242-CAN BUS MESSAGE MISSING.**

**When Monitored and Set Condition:**

**P1242-CAN BUS MESSAGE MISSING**

When Monitored: With the ignition on.

Set Condition: The ECM detects an open on the CAN Bus circuit.

**P1242-CAN BUS MESSAGE MISSING FROM TCM**

When Monitored: With the ignition on.

Set Condition: The ECM does not receive an expected CAN Bus message from the TCM.

<b>POSSIBLE CAUSES</b>	
CAN C BUS CIRCUITS OPEN	
CAN C BUS CIRCUITS SHORTED TO GROUND	
CAN C BUS CIRCUITS SHORTED TOGETHER	
ENGINE CONTROL MODULE	
TRANSMISSION CONTROL MODULE	
INTERMITTENT CONDITION	
ABS - TERMINATING RESISTOR	
ECM - CAN C BUS CIRCUIT	
TCM - TERMINATING RESISTOR	

<b>TEST</b>	<b>ACTION</b>	<b>APPLICABILITY</b>
1	<p><b>NOTE: This DTC indicates a communication problem between the TCM and the ECM.</b></p> <p>Turn the ignition on.                      With the DRB, erase ECM DTCs.                      Perform several engine run cycles, turning the ignition off for at least 20 seconds between each engine run cycle.                      With the DRBIII®, read the ECM DTCs.                      Did this DTC set again?</p> <p style="padding-left: 40px;">Yes → Go To 2</p> <p style="padding-left: 40px;">No → Go To 8</p>	All

**P1242-CAN BUS MESSAGE MISSING — Continued**

TEST	ACTION	APPLICABILITY
2	Turn the ignition off. Disconnect the ECM harness connectors. Disconnect the TCM harness connectors. Measure and note the resistance of the CAN C Bus (+) circuit between the ECM harness connector and the TCM harness connector. Measure and note the resistance of the CAN C Bus (-) circuit between the ECM harness connector and the TCM harness connector. Is the resistance below 10.0 ohms for each measurement?  Yes → Go To 3  No → Repair the CAN C Bus circuit(s) for an open. Perform ROAD TEST VERIFICATION - VER-2.	All
3	Turn the ignition off. Disconnect the ECM harness connectors. Disconnect the TCM harness connectors. Disconnect the CAB harness connector. Measure and note the resistance between ground and the CAN C Bus (+) circuit at the TCM harness connector. Measure and note the resistance between ground and the CAN C Bus (-) circuit at the TCM harness connector. Is the resistance above 1000 ohms for each measurement?  Yes → Go To 4  No → Repair the CAN C Bus circuit(s) for a short to ground. Perform ROAD TEST VERIFICATION - VER-2.	All
4	Turn the ignition off. Disconnect the ECM harness connectors. Disconnect the TCM harness connectors. Disconnect the CAB harness connector. Measure and note the resistance between the CAN C Bus (+) circuit and the CAN C Bus (-) circuit at the TCM harness connector. Is the resistance above 1000 ohms?  Yes → Go To 5  No → Repair the CAN C Bus circuit(s) for a short together. Perform ROAD TEST VERIFICATION - VER-2.	All
5	Turn the ignition off to the lock position. Disconnect the ECM harness connector. <b>NOTE: Make sure both the TCM and the CAB harness connectors are connected before taking this measurement.</b> Measure the resistance between the CAN C Bus (+) circuit and the CAN C Bus (-) circuit in the ECM harness connector. Is the resistance 60.0 ohms, ± 3.0 ohms?  Yes → Go To 6  No → Go To 7	All

**P1242-CAN BUS MESSAGE MISSING — Continued**

TEST	ACTION	APPLICABILITY
6	<p>Turn the ignition off.                      Replace and program the Transmission Control Module in accordance with the Service Information.                      Turn the ignition on.                      With the DRB, erase all ECM and TCM DTC's.                      Perform several engine run cycles, turning the engine off for at least 20 seconds between each cycle.                      With the DRBIII®, read the ECM DTCs.                      Does the DRBIII® display this DTC?</p> <p>Yes → Replace and program the Engine Control Module in accordance with the Service Information.                      Perform ROAD TEST VERIFICATION - VER-2.</p> <p>No → Test Complete.                      Perform ROAD TEST VERIFICATION - VER-2.</p>	All
7	<p>Turn the ignition off to the lock position.                      Disconnect the CAB harness connector.  <b>NOTE: Make sure both the TCM and the ECM harness connectors are connected before taking this measurement.</b>                      Measure the resistance between the CAN Bus (+) circuit and the CAN Bus (-) circuit in the CAB harness connector.                      Is the resistance 120 ohms, ± 2.0 ohms?</p> <p>Yes → Replace the CAB Module.                      Perform ROAD TEST VERIFICATION - VER-2.</p> <p>No → Replace the Transmission Control Module.                      Perform ROAD TEST VERIFICATION - VER-2.</p>	All
8	<p><b>WARNING: WHEN THE ENGINE IS OPERATING, DO NOT STAND IN A DIRECT LINE WITH THE FAN. DO NOT PUT YOUR HANDS NEAR THE PULLEYS, BELTS OR FAN. DO NOT WEAR LOOSE CLOTHING.</b>  <b>NOTE: The conditions that set the DTC are not present at this time. The following list may help in identifying the intermittent condition.</b>                      With the engine running at normal operating temperature, monitor the DRB parameters related to the DTC while wiggling the wiring harness. Look for parameter values to change and/or a DTC to set.                      Review the DTC When Monitored and Set Conditions. If possible, try to duplicate the conditions under which the DTC was set.                      Refer to any Technical Service Bulletins (TSB) that may apply.                      Visually inspect the related wiring harness. Look for any chafed, pierced, pinched, or partially broken wires.                      Visually inspect the related wiring harness connectors. Look for broken, bent, pushed out, or corroded terminals.                      Were any of the above conditions present?</p> <p>Yes → Repair as necessary.                      Perform ROAD TEST VERIFICATION - VER-2.</p> <p>No → Test Complete.</p>	All

**Symptom:**  
**P1242-CAN BUS MUTE**

**When Monitored and Set Condition:**

**P1242-CAN BUS MUTE**

When Monitored: With the ignition on.

Set Condition: The ECM does not detect any CAN Bus messages.

**POSSIBLE CAUSES**

ENGINE CONTROL MODULE  
INTERMITTENT CONDITION  
CAN C BUS CIRCUIT OPEN

TEST	ACTION	APPLICABILITY
1	Turn the ignition on. With the DRB, erase ECM DTCs. Start the engine. Monitor the DRB for ECM DTCs. Did this DTC set again?  Yes → Go To 2 No → Go To 3	All
2	<b>NOTE: At any time, if one of the measurements is above 5.0 ohms, answer the question.</b> Turn the ignition off. Disconnect the TCM harness connector. Disconnect the ECM harness connectors. Measure the resistance of the CAN C Bus (+) circuit between the ECM and the TCM harness connectors. Measure the resistance of the CAN C Bus (-) circuit between the ECM and the TCM harness connectors. Disconnect the CAB harness connector. Measure the resistance of the CAN C Bus (+) circuit between the ECM and CAB harness connectors. Measure the resistance of the CAN C Bus (-) circuit between the ECM and CAB harness connectors. Is the resistance below 5.0 ohms for each measurement?  Yes → Replace and program the Engine Control Module in accordance with the Service Information. Perform ROAD TEST VERIFICATION - VER-2.  No → Repair the CAN C Bus circuit that measured greater than 5.0 ohms for an open. Perform ROAD TEST VERIFICATION - VER-2.	All



**P1242-CAN BUS MUTE — Continued**

TEST	ACTION	APPLICABILITY
3	<p><b>WARNING: WHEN THE ENGINE IS OPERATING, DO NOT STAND IN A DIRECT LINE WITH THE FAN. DO NOT PUT YOUR HANDS NEAR THE PULLEYS, BELTS OR FAN. DO NOT WEAR LOOSE CLOTHING.</b></p> <p><b>NOTE: The conditions that set the DTC are not present at this time. The following list may help in identifying the intermittent condition.</b></p> <p>With the engine running at normal operating temperature, monitor the DRB parameters related to the DTC while wiggling the wiring harness. Look for parameter values to change and/or a DTC to set.</p> <p>Review the DTC When Monitored and Set Conditions. If possible, try to duplicate the conditions under which the DTC was set.</p> <p>Refer to any Technical Service Bulletins (TSB) that may apply.</p> <p>Visually inspect the related wiring harness. Look for any chafed, pierced, pinched, or partially broken wires.</p> <p>Visually inspect the related wiring harness connectors. Look for broken, bent, pushed out, or corroded terminals.</p> <p>Were any of the above conditions present?</p> <p style="padding-left: 40px;">Yes → Repair as necessary. Perform ROAD TEST VERIFICATION - VER-2.</p> <p style="padding-left: 40px;">No → Test Complete.</p>	All

**Symptom:****P1270-INTAKE PORT SWIRL ACTUATOR SHORT CIRCUIT****When Monitored and Set Condition:****P1270-INTAKE PORT SWIRL ACTUATOR SHORT CIRCUIT**

**When Monitored:** With the ignition on and the ECM attempting to actuate the Intake Port Swirl Actuator.

**Set Condition:** The ECM detects excessive current on the Intake Port Swirl Actuator Control circuit.

**POSSIBLE CAUSES**

INTERMITTENT CONDITION

SWIRL SOLENOID

SWIRL SOLENOID CONTROL SHORT TO VOLTAGE

ECM

<b>TEST</b>	<b>ACTION</b>	<b>APPLICABILITY</b>
1	Turn the ignition on. With the DRB, erase ECM DTCs. With the DRBIII®, actuate the Swirl Solenoid. With the DRBIII®, read the ECM DTCs. Did this DTC set again?  Yes → Go To 2  No → Go To 4	All
2	Turn the ignition off. Disconnect the Swirl Solenoid harness connector. Disconnect the ECM harness connectors. Remove the ASD Relay from the PDC. Connect a jumper wire between cavity 30 and cavity 87 of the ASD Relay connector. Turn the ignition on. Measure the voltage of the Swirl Solenoid Control circuit. Is the voltage below 1.0 volt?  Yes → Go To 3  No → Repair the Swirl Solenoid Control circuit for a short to voltage. Perform ROAD TEST VERIFICATION - VER-2.	All

**P1270-INTAKE PORT SWIRL ACTUATOR SHORT CIRCUIT — Continued**

TEST	ACTION	APPLICABILITY
3	<p>Turn the ignition off.                      Install a substitute Swirl Solenoid.                      Turn the ignition on.                      With the DRB, erase ECM DTCs.                      With the DRBIII®, actuate the Swirl Solenoid.                      With the DRBIII®, read the ECM DTCs.                      Does the DRB display this DTC?</p> <p>Yes → Replace and program the Engine Control Module in accordance with the Service Information.                      Perform ROAD TEST VERIFICATION - VER-2.</p> <p>No → Replace the Swirl Solenoid.                      Perform ROAD TEST VERIFICATION - VER-2.</p>	All
4	<p><b>WARNING: WHEN THE ENGINE IS OPERATING, DO NOT STAND IN A DIRECT LINE WITH THE FAN. DO NOT PUT YOUR HANDS NEAR THE PULLEYS, BELTS OR FAN. DO NOT WEAR LOOSE CLOTHING.</b></p> <p><b>NOTE: The conditions that set the DTC are not present at this time. The following list may help in identifying the intermittent condition.</b></p> <p>With the engine running at normal operating temperature, monitor the DRB parameters related to the DTC while wiggling the wiring harness. Look for parameter values to change and/or a DTC to set.</p> <p>Review the DTC When Monitored and Set Conditions. If possible, try to duplicate the conditions under which the DTC was set.</p> <p>Refer to any Technical Service Bulletins (TSB) that may apply.</p> <p>Visually inspect the related wiring harness. Look for any chafed, pierced, pinched, or partially broken wires.</p> <p>Visually inspect the related wiring harness connectors. Look for broken, bent, pushed out, or corroded terminals.</p> <p>Were any of the above conditions present?</p> <p>Yes → Repair as necessary.                      Perform ROAD TEST VERIFICATION - VER-2.</p> <p>No → Test Complete.</p>	All

**Symptom:**

**P1270-INTAKE PORT SWIRL ACTUATOR GROUND X**

---

**When Monitored and Set Condition:**

**P1270-INTAKE PORT SWIRL ACTUATOR GROUND X**

When Monitored: With the ignition on.

Set Condition: The ECM detects an internal fault with the Intake Port Swirl Actuator.

---

**POSSIBLE CAUSES**

INTAKE PORT SWIRL ACTUATOR

---

**Repair Instructions:**

**INTAKE PORT SWIRL ACTUATOR**

Replace the Intake Port Swirl Actuator.

Perform ROAD TEST VERIFICATION - VER-2.

**Symptom:**

**P1270-INTAKE PORT SWIRL ACTUATOR OPEN CIRCUIT**

**When Monitored and Set Condition:**

**P1270-INTAKE PORT SWIRL ACTUATOR OPEN CIRCUIT**

When Monitored: With the ignition on.

Set Condition: The ECM does not detect voltage on the Intake Port Swirl Actuator Control circuit.

**POSSIBLE CAUSES**

INTERMITTENT CONDITION  
 ASD RELAY OUTPUT CIRCUIT OPEN  
 SWIRL SOLENOID CONTROL CIRCUIT SHORTED TO GROUND  
 SWIRL SOLENOID CONTROL CKT OPEN  
 SWIRL SOLENOID  
 ENGINE CONTROL MODULE

TEST	ACTION	APPLICABILITY
1	Turn the ignition on. With the DRB, erase ECM DTCs. With the DRBIII®, actuate the Swirl Solenoid. Monitor the DRB for ECM DTCs. Did this DTC set again?  Yes → Go To 2 No → Go To 6	All
2	Turn the ignition off. Disconnect the Swirl Solenoid harness connector. Turn the ignition on. Using a 12-volt test light connected to ground, check the ASD Relay Output circuit. Does the test light illuminate brightly?  Yes → Go To 3 No → Repair the ASD Relay Output circuit for an open. Perform ROAD TEST VERIFICATION - VER-2.	All
3	Turn the ignition off. Disconnect the Swirl Solenoid harness connector. Disconnect the ECM harness connectors. Measure the resistance between ground and the Swirl Solenoid Control circuit. Is the resistance above 1000 ohms?  Yes → Go To 4 No → Repair the Swirl Solenoid Control circuit for a short to ground. Perform ROAD TEST VERIFICATION - VER-2.	All

**P1270-INTAKE PORT SWIRL ACTUATOR OPEN CIRCUIT — Continued**

TEST	ACTION	APPLICABILITY
4	Turn the ignition off. Disconnect the Swirl Solenoid harness connector. Disconnect the ECM harness connectors. Measure the resistance of the Swirl Solenoid Control circuit. Is the resistance below 10.0 ohms?  Yes → Go To 5  No → Repair the Swirl Solenoid Control circuit for an open. Perform ROAD TEST VERIFICATION - VER-2.	All
5	Turn the ignition off. Install a substitute Swirl Solenoid in place of the vehicle's Swirl Solenoid. <b>NOTE: Ensure the ECM and Swirl Solenoid harness connectors are connected.</b> Turn the ignition on. With the DRBIII®, actuate the Swirl Solenoid. With the DRB, check for this DTC to set again. Did this DTC set again?  Yes → Replace and program the Engine Control Module in accordance with the Service Information. Perform ROAD TEST VERIFICATION - VER-2.  No → Replace the Swirl Solenoid. Perform ROAD TEST VERIFICATION - VER-2.	All
6	<b>WARNING: WHEN THE ENGINE IS OPERATING, DO NOT STAND IN A DIRECT LINE WITH THE FAN. DO NOT PUT YOUR HANDS NEAR THE PULLEYS, BELTS OR FAN. DO NOT WEAR LOOSE CLOTHING.</b> <b>NOTE: The conditions that set the DTC are not present at this time. The following list may help in identifying the intermittent condition.</b> With the engine running at normal operating temperature, monitor the DRB parameters related to the DTC while wiggling the wiring harness. Look for parameter values to change and/or a DTC to set. Review the DTC When Monitored and Set Conditions. If possible, try to duplicate the conditions under which the DTC was set. Refer to any Technical Service Bulletins (TSB) that may apply. Visually inspect the related wiring harness. Look for any chafed, pierced, pinched, or partially broken wires. Visually inspect the related wiring harness connectors. Look for broken, bent, pushed out, or corroded terminals. Were any of the above conditions present?  Yes → Repair as necessary. Perform ROAD TEST VERIFICATION - VER-2.  No → Test Complete.	All

**Symptom:**

**P1499-HYDRAULIC COOLING FAN SOLENOID CIRCUIT OPEN CIRCUIT**

**When Monitored and Set Condition:**

**P1499-HYDRAULIC COOLING FAN SOLENOID CIRCUIT OPEN CIRCUIT**

When Monitored: With the ignition on.

Set Condition: The ECM does not detect voltage on the Hydraulic Cooling Fan Solenoid Control circuit.

POSSIBLE CAUSES
INTERMITTENT CONDITION ASD RELAY OUTPUT CIRCUIT OPEN HYDRAULIC COOLING FAN SOLENOID CONTROL CIRCUIT SHORTED TO GROUND HYDRAULIC COOLING FAN SOLENOID CONTROL CKT OPEN HYDRAULIC COOLING FAN SOLENOID ENGINE CONTROL MODULE

TEST	ACTION	APPLICABILITY
1	Turn the ignition on. With the DRB, erase ECM DTCs. With the DRBIII®, actuate the Hydraulic Cooling Fan Solenoid. Monitor the DRB for ECM DTCs. Did this DTC set again?  Yes → Go To 2 No → Go To 6	All
2	Turn the ignition off. Disconnect the Hydraulic Cooling Fan Solenoid harness connector. Turn the ignition on. Using a 12-volt test light connected to ground, check the ASD Relay Output circuit. Does the test light illuminate brightly?  Yes → Go To 3 No → Repair the ASD Relay Output circuit for an open. Perform ROAD TEST VERIFICATION - VER-2.	All

**P1499-HYDRAULIC COOLING FAN SOLENOID CIRCUIT OPEN CIRCUIT**

— Continued

TEST	ACTION	APPLICABILITY
3	Turn the ignition off. Disconnect the Hydraulic Cooling Fan Solenoid harness connector. Disconnect the ECM harness connectors. Measure the resistance between ground and the Swirl Solenoid Control circuit. Is the resistance above 1000 ohms?  Yes → Go To 4  No → Repair the Hydraulic Cooling Fan Solenoid Control circuit for a short to ground. Perform ROAD TEST VERIFICATION - VER-2.	All
4	Turn the ignition off. Disconnect the Hydraulic Cooling Fan Solenoid harness connector. Disconnect the ECM harness connectors. Measure the resistance of the Swirl Solenoid Control circuit. Is the resistance below 10.0 ohms?  Yes → Go To 5  No → Repair the Hydraulic Cooling Fan Solenoid Control circuit for an open. Perform ROAD TEST VERIFICATION - VER-2.	All
5	Turn the ignition off. Install a substitute Hydraulic Cooling Fan Solenoid in place of the vehicle's Hydraulic Cooling Fan Solenoid. <b>NOTE: Ensure the ECM and Hydraulic Cooling Fan Solenoid harness connectors are connected.</b> Turn the ignition on. With the DRBIII®, actuate the Hydraulic Cooling Fan Solenoid. With the DRB, check for this DTC to set again. Did this DTC set again?  Yes → Replace and program the Engine Control Module in accordance with the Service Information. Perform ROAD TEST VERIFICATION - VER-2.  No → Replace the Hydraulic Cooling Fan Solenoid. Perform ROAD TEST VERIFICATION - VER-2.	All



**P1499-HYDRAULIC COOLING FAN SOLENOID CIRCUIT OPEN CIRCUIT**  
 — Continued

TEST	ACTION	APPLICABILITY
6	<p><b>WARNING: WHEN THE ENGINE IS OPERATING, DO NOT STAND IN A DIRECT LINE WITH THE FAN. DO NOT PUT YOUR HANDS NEAR THE PULLEYS, BELTS OR FAN. DO NOT WEAR LOOSE CLOTHING.</b></p> <p><b>NOTE: The conditions that set the DTC are not present at this time. The following list may help in identifying the intermittent condition.</b></p> <p>With the engine running at normal operating temperature, monitor the DRB parameters related to the DTC while wiggling the wiring harness. Look for parameter values to change and/or a DTC to set.</p> <p>Review the DTC When Monitored and Set Conditions. If possible, try to duplicate the conditions under which the DTC was set.</p> <p>Refer to any Technical Service Bulletins (TSB) that may apply.</p> <p>Visually inspect the related wiring harness. Look for any chafed, pierced, pinched, or partially broken wires.</p> <p>Visually inspect the related wiring harness connectors. Look for broken, bent, pushed out, or corroded terminals.</p> <p>Were any of the above conditions present?</p> <p style="padding-left: 40px;">Yes → Repair as necessary. Perform ROAD TEST VERIFICATION - VER-2.</p> <p style="padding-left: 40px;">No → Test Complete.</p>	All

**Symptom:**

**P1499-HYDRAULIC COOLING FAN SOLENOID CIRCUIT SHORT CIRCUIT**

**When Monitored and Set Condition:**

**P1499-HYDRAULIC COOLING FAN SOLENOID CIRCUIT SHORT CIRCUIT**

When Monitored: With the ignition on and the ECM attempting to actuate the Hydraulic Cooling Fan Solenoid.

Set Condition: The ECM detects excessive current on the Hydraulic Cooling Fan Solenoid Control circuit.

POSSIBLE CAUSES
INTERMITTENT CONDITION HYDRAULIC COOLING FAN SOLENOID HYDRAULIC COOLING FAN SOLENOID CONTROL SHORT TO VOLTAGE ECM

TEST	ACTION	APPLICABILITY
1	Turn the ignition on. With the DRB, erase ECM DTCs. With the DRBIII®, actuate the Hydraulic Cooling Fan Solenoid. With the DRBIII®, read the ECM DTCs. Did this DTC set again?  Yes → Go To 2  No → Go To 4	All
2	Turn the ignition off. Disconnect the Hydraulic Cooling Fan Solenoid harness connector. Disconnect the ECM harness connectors. Remove the ASD Relay from the PDC. Connect a jumper wire between cavity 30 and cavity 87 of the ASD Relay connector. Turn the ignition on. Measure the voltage of the Hydraulic Cooling Fan Solenoid Control circuit. Is the voltage below 1.0 volt?  Yes → Go To 3  No → Repair the Hydraulic Cooling Fan Solenoid Control circuit for a short to voltage. Perform ROAD TEST VERIFICATION - VER-2.	All

**P1499-HYDRAULIC COOLING FAN SOLENOID CIRCUIT SHORT CIRCUIT — Continued**

TEST	ACTION	APPLICABILITY
3	<p>Turn the ignition off.                      Install a substitute Hydraulic Cooling Fan Solenoid.                      Turn the ignition on.                      With the DRB, erase ECM DTCs.                      With the DRBIII®, actuate the Hydraulic Cooling Fan Solenoid.                      With the DRBIII®, read the ECM DTCs.                      Does the DRB display this DTC?</p> <p>Yes → Replace and program the Engine Control Module in accordance with the Service Information.                      Perform ROAD TEST VERIFICATION - VER-2.</p> <p>No → Replace the Hydraulic Cooling Fan Solenoid.                      Perform ROAD TEST VERIFICATION - VER-2.</p>	All
4	<p><b>WARNING: WHEN THE ENGINE IS OPERATING, DO NOT STAND IN A DIRECT LINE WITH THE FAN. DO NOT PUT YOUR HANDS NEAR THE PULLEYS, BELTS OR FAN. DO NOT WEAR LOOSE CLOTHING.</b></p> <p><b>NOTE: The conditions that set the DTC are not present at this time. The following list may help in identifying the intermittent condition.</b></p> <p>With the engine running at normal operating temperature, monitor the DRB parameters related to the DTC while wiggling the wiring harness. Look for parameter values to change and/or a DTC to set.</p> <p>Review the DTC When Monitored and Set Conditions. If possible, try to duplicate the conditions under which the DTC was set.</p> <p>Refer to any Technical Service Bulletins (TSB) that may apply.</p> <p>Visually inspect the related wiring harness. Look for any chafed, pierced, pinched, or partially broken wires.</p> <p>Visually inspect the related wiring harness connectors. Look for broken, bent, pushed out, or corroded terminals.</p> <p>Were any of the above conditions present?</p> <p>Yes → Repair as necessary.                      Perform ROAD TEST VERIFICATION - VER-2.</p> <p>No → Test Complete.</p>	All

**Symptom List:**

**P1511-BATTERY SENSE LINE 1 VOLTAGE TOO HIGH**  
**P1511-BATTERY SENSE LINE 1 VOLTAGE TOO LOW**  
**P1512-BATTERY SENSE LINE 2 VOLTAGE TOO HIGH**  
**P1512-BATTERY SENSE LINE 2 VOLTAGE TOO LOW**

**Test Note: All symptoms listed above are diagnosed using the same tests. The title for the tests will be P1511-BATTERY SENSE LINE 1 VOLTAGE TOO HIGH.**

**When Monitored and Set Condition:****P1511-BATTERY SENSE LINE 1 VOLTAGE TOO HIGH**

When Monitored: With the ignition on or the engine running.

Set Condition: The ECM detects Battery Sense circuit voltage above 16.0 volts.

**P1511-BATTERY SENSE LINE 1 VOLTAGE TOO LOW**

When Monitored: With the ignition on or the engine running.

Set Condition: The ECM detects Battery Sense circuit voltage below 6.0 volts.

**P1512-BATTERY SENSE LINE 2 VOLTAGE TOO HIGH**

When Monitored: With the ignition on or the engine running.

Set Condition: The ECM detects Battery Sense circuit voltage above 2.0 volts.

**P1512-BATTERY SENSE LINE 2 VOLTAGE TOO LOW**

When Monitored: With the ignition on or the engine running.

Set Condition: The ECM detects Battery Sense circuit voltage below -2.0 volts.

**POSSIBLE CAUSES**

INTERMITTENT CONDITION  
 FUSE 26 OPEN  
 ECM GROUND CIRCUIT(S) OPEN  
 BATTERY(-) SENSE CIRCUIT SHORTED TO VOLTAGE  
 BATTERY(-) SENSE CIRCUIT OPEN  
 BATTERY(+) SENSE CIRCUIT SHORTED TO GROUND  
 BATTERY(+) SENSE CIRCUIT OPEN  
 ENGINE CONTROL MODULE

**P1511-BATTERY SENSE LINE 1 VOLTAGE TOO HIGH — Continued**

TEST	ACTION	APPLICABILITY
1	<p><b>NOTE: If DTC P0560-SYSTEM VOLTAGE TOO HIGH is present with this DTC, perform diagnostics for P0560 first.</b>                      Turn the ignition on.                      With the DRBIII®, erase the ECM DTCs.                      Test drive the vehicle.                      With the DRBIII®, read the ECM DTCs.                      Does the DRBIII® display this DTC?</p> <p>Yes → Go To 2                      No → Go To 9</p>	All
2	<p>Turn the ignition off.                      Remove and inspect Fuse 26 from the PDC.                      Is the fuse OK?</p> <p>Yes → Go To 3                      No → Repair the short that caused the fuse to open and replace the fuse.                      Perform ROAD TEST VERIFICATION - VER-2.</p>	All
3	<p>Turn the ignition off.                      Disconnect the ECM harness connectors.                      Using a 12-volt test light connected to 12-volts, check both of the ECM ground circuits in ECM harness connector C1 cavities 1 and 2.                      Did the test light illuminate for both cavities?</p> <p>Yes → Go To 4                      No → Repair the ECM Ground circuit(s) for an open.                      Perform ROAD TEST VERIFICATION - VER-2.</p>	All
4	<p>Turn the ignition off.                      Disconnect the ECM harness connectors.                      Remove the ASD Relay from the PDC.                      Connect a jumper wire between cavity 30 and cavity 87 of the ASD Relay connector.                      Turn the ignition on.                      Measure the voltage of the Battery (-) Sense circuit in ECM harness connector cavity C1-20.                      Is the voltage below 1.0 volt?</p> <p>Yes → Go To 5                      No → Repair the Battery(-) Sense circuit for a short to voltage.                      Perform ROAD TEST VERIFICATION - VER-2.</p>	All
5	<p>Turn the ignition off.                      Disconnect the ECM harness connectors.                      Remove Fuse 26 from the PDC.  <b>NOTE: A short to ground on any circuit associated with Fuse 6 or 26 may cause this DTC to set.</b>                      Measure the resistance between ground and the Battery(+) Sense circuit in ECM harness connector C1-19.                      Is the resistance above 100 kohms?</p> <p>Yes → Go To 6                      No → Repair the Battery(+) Sense circuit for a short to ground.                      Perform ROAD TEST VERIFICATION - VER-2.</p>	All

**P1511-BATTERY SENSE LINE 1 VOLTAGE TOO HIGH — Continued**

TEST	ACTION	APPLICABILITY
6	Turn the ignition off. Disconnect the ECM harness connectors. Measure the resistance between the Battery negative terminal and the Battery(-) Sense circuit in ECM harness connector cavity C1-20. Is the resistance below 5.0 ohms?  Yes → Go To 7  No → Repair the Battery(-) Sense circuit for an open. Perform ROAD TEST VERIFICATION - VER-2.	All
7	Turn the ignition off. Disconnect the ECM harness connectors. Remove Fuse 26 from the PDC. Measure the resistance of the Battery(+) Sense circuit. Is the resistance below 5.0 ohms?  Yes → Go To 8  No → Repair the Battery(+) Sense circuit for an open. Perform ROAD TEST VERIFICATION - VER-2.	All
8	If there are no possible causes remaining, view repair.  Repair Replace and program the Engine Control Module in accordance with the Service Information. Perform ROAD TEST VERIFICATION - VER-2.	All
9	<b>WARNING: WHEN THE ENGINE IS OPERATING, DO NOT STAND IN A DIRECT LINE WITH THE FAN. DO NOT PUT YOUR HANDS NEAR THE PULLEYS, BELTS OR FAN. DO NOT WEAR LOOSE CLOTHING.</b> <b>NOTE: The conditions that set the DTC are not present at this time. The following list may help in identifying the intermittent condition.</b> With the engine running and at normal operating temperature, monitor the DRB parameters related to the DTC while wiggling the wiring harness. Look for parameter values to change and/or a DTC to set. Review the DTC When Monitored and Set Conditions. If possible, try to duplicate the conditions under which the DTC was set. Refer to any Technical Service Bulletins (TSB) that may apply. Visually inspect the related wiring harness. Look for any chafed, pierced, pinched, or partially broken wires. Visually inspect the related wiring harness connectors. Look for broken, bent, pushed out, or corroded terminals. Were any of the above conditions present?  Yes → Repair as necessary. Perform ROAD TEST VERIFICATION - VER-2.  No → Test Complete.	All

**Symptom:**

**P1605-IGNITION SWITCH PLAUSIBILITY**

**When Monitored and Set Condition:**

**P1605-IGNITION SWITCH PLAUSIBILITY**

When Monitored: When the ignition is first turned on.

Set Condition: The ECM detects the Ignition Switch Sense momentarily return to the OFF state during ECM initialization.

**POSSIBLE CAUSES**

INTERMITTENT CONDITION

ENGINE CONTROL MODULE

FUSED IGNITION SWITCH OUTPUT (RUN/START) CIRCUIT OPEN

FUSED IGNITION SWITCH OUTPUT (RUN/START) CIRCUIT SHORTED TO GROUND

TEST	ACTION	APPLICABILITY
1	<p><b>NOTE: This DTC is set when the ECM sees a change from On to Off and then back On within a few milliseconds during ECM initialization at Key On. Look for an intermittent open or short to ground on the Ignition Switch Sense circuit.</b></p> <p>Turn the ignition on.                      With the DRB, erase ECM DTCs.                      Cycle the ignition switch on and off several times, pausing for at least 10 seconds at each key off and key on.                      Turn the ignition on.                      With the DRB, read ECM DTCs.                      Did this DTC set again?</p> <p>Yes → Go To 2                      No → Go To 5</p>	All
2	<p>Turn the ignition off.                      Disconnect the ECM harness connectors.                      Disconnect the ignition switch harness connector.                      Measure the resistance of the Fused Ignition Switch Output (RUN/START) circuit.                      Is the resistance below 5.0 ohms?</p> <p>Yes → Go To 3                      No → Repair the Fused Ignition Switch Output (RUN/START) circuit for an open.                      Perform ROAD TEST VERIFICATION - VER-2.</p>	All

**P1605-IGNITION SWITCH PLAUSIBILITY — Continued**

TEST	ACTION	APPLICABILITY
3	Turn the ignition off. Disconnect the ECM harness connectors. Disconnect the ignition switch harness connector. Measure the resistance between ground and the Fused Ignition Switch Output (RUN/START) circuit. Is the resistance above 100 kohms?  Yes → Go To 4  No → Repair the Fused Ignition Switch Output (RUN/START) circuit for a short to ground. Perform ROAD TEST VERIFICATION - VER-2.	All
4	If there are no possible causes remaining, view repair.  Repair Using the schematic, ensure no shared circuits on the Fused Ignition Switch Output (RUN/START) ckt are causing an initial low spike in circuit voltage. If all other components are OK, replace and program the ECM in accordance with the Service Information. Perform ROAD TEST VERIFICATION - VER-2.	All
5	<b>WARNING: WHEN THE ENGINE IS OPERATING, DO NOT STAND IN A DIRECT LINE WITH THE FAN. DO NOT PUT YOUR HANDS NEAR THE PULLEYS, BELTS OR FAN. DO NOT WEAR LOOSE CLOTHING.</b> <b>NOTE: The conditions that set the DTC are not present at this time. The following list may help in identifying the intermittent condition.</b> With the engine running at normal operating temperature, monitor the DRB parameters related to the DTC while wiggling the wiring harness. Look for parameter values to change and/or a DTC to set. Review the DTC When Monitored and Set Conditions. If possible, try to duplicate the conditions under which the DTC was set. Refer to any Technical Service Bulletins (TSB) that may apply. Visually inspect the related wiring harness. Look for any chafed, pierced, pinched, or partially broken wires. Visually inspect the related wiring harness connectors. Look for broken, bent, pushed out, or corroded terminals. Were any of the above conditions present?  Yes → Repair as necessary. Perform ROAD TEST VERIFICATION - VER-2.  No → Test Complete.	All



**Symptom List:**

- P1643-VISCOUS HEATER RELAY OPEN CIRCUIT**
- P1643-VISCOUS HEATER RELAY SHORT CIRCUIT**

**Test Note: All symptoms listed above are diagnosed using the same tests. The title for the tests will be P1643-VISCOUS HEATER RELAY OPEN CIRCUIT.**

**When Monitored and Set Condition:**

**P1643-VISCOUS HEATER RELAY OPEN CIRCUIT**

When Monitored: With the ignition on.

Set Condition: The ECM does not detect voltage on the Viscous Heater Relay Control circuit.

**P1643-VISCOUS HEATER RELAY SHORT CIRCUIT**

When Monitored: With the ignition on.

Set Condition: The ECM detects excessive current on the Viscous Heater Relay Control circuit.

<b>POSSIBLE CAUSES</b>	
INTERMITTENT CONDITION	
ASD RELAY OUTPUT CIRCUIT OPEN	
SUBSTITUTE VISCOUS HEATER RELAY	
VISCOUS HEATER RELAY CONTROL CIRCUIT SHORTED TO VOLTAGE	
VISCOUS HEATER RELAY CONTROL CIRCUIT SHORTED TO GROUND	
VAISCOUS HEATER RELAY CONTROL CIRCUIT OPEN	
ENGINE CONTROL MODULE	

<b>TEST</b>	<b>ACTION</b>	<b>APPLICABILITY</b>
1	Turn the ignition on. With the DRBIII®, actuate the Viscous Heater Relay. Is the Viscous Heater Relay clicking?  Yes → Go To 2  No → Go To 3	All

**P1643-VISCOUS HEATER RELAY OPEN CIRCUIT — Continued**

TEST	ACTION	APPLICABILITY
2	<p><b>WARNING: WHEN THE ENGINE IS OPERATING, DO NOT STAND IN A DIRECT LINE WITH THE FAN. DO NOT PUT YOUR HANDS NEAR THE PULLEYS, BELTS OR FAN. DO NOT WEAR LOOSE CLOTHING.</b></p> <p><b>NOTE: The conditions that set the DTC are not present at this time. The following list may help in identifying the intermittent condition.</b></p> <p>With the engine running at normal operating temperature, monitor the DRB parameters related to the DTC while wiggling the wiring harness. Look for parameter values to change and/or a DTC to set.</p> <p>Review the DTC When Monitored and Set Conditions. If possible, try to duplicate the conditions under which the DTC was set.</p> <p>Refer to any Technical Service Bulletins (TSB) that may apply.</p> <p>Visually inspect the related wiring harness. Look for any chafed, pierced, pinched, or partially broken wires.</p> <p>Visually inspect the related wiring harness connectors. Look for broken, bent, pushed out, or corroded terminals.</p> <p>Were any of the above conditions present?</p> <p style="padding-left: 40px;">Yes → Repair as necessary. Perform ROAD TEST VERIFICATION - VER-2.</p> <p style="padding-left: 40px;">No → Test Complete.</p>	All
3	<p>Turn the ignition off.</p> <p>Disconnect the Viscous Heater Relay from the PDC.</p> <p>Turn the ignition on.</p> <p>Using a 12-volt test light connected to ground, check the ASD Relay Output circuit at the Viscous Heater Relay connector in the PDC.</p> <p>Does the test light illuminate brightly?</p> <p style="padding-left: 40px;">Yes → Go To 4</p> <p style="padding-left: 40px;">No → Repair the ASD Relay Output circuit for an open. Perform ROAD TEST VERIFICATION - VER-2.</p>	All
4	<p>Turn the ignition off.</p> <p>Install a substitute relay in place of the Viscous Heater Relay.</p> <p>Turn the ignition on.</p> <p>With the DRB, actuate the Viscous/Cabin Heater Relay for at least 20 seconds.</p> <p>With the DRB, read ECM DTCs.</p> <p>Did this DTC set again?</p> <p style="padding-left: 40px;">Yes → Go To 5</p> <p style="padding-left: 40px;">No → Replace the Viscous Heater Relay. Perform ROAD TEST VERIFICATION - VER-2.</p>	All
5	<p>Turn the ignition off.</p> <p>Disconnect the ECM harness connectors.</p> <p>Remove the Viscous Heater Relay.</p> <p>Remove the ASD Relay from the PDC.</p> <p>Connect a jumper wire between cavity 30 and cavity 87 of the ASD Relay connector in the PDC.</p> <p>Turn the ignition on.</p> <p>Measure the voltage on the Viscous Heater Relay Control circuit.</p> <p>Is the voltage above 1.0 volt?</p> <p style="padding-left: 40px;">Yes → Repair the Viscous Heater Relay Control circuit for a short to voltage. Perform ROAD TEST VERIFICATION - VER-2.</p> <p style="padding-left: 40px;">No → Go To 6</p>	All

**P1643-VISCOUS HEATER RELAY OPEN CIRCUIT — Continued**

TEST	ACTION	APPLICABILITY
6	Turn the ignition off. Remove the Viscous Heater Relay from the PDC. Disconnect the ECM harness connectors. Measure the resistance between ground and the Viscous Heater Relay Control circuit. Is the resistance above 1000 ohms?  Yes → Go To 7  No → Repair the Viscous Heater Relay Control circuit for a short to ground. Perform ROAD TEST VERIFICATION - VER-2.	All
7	Turn the ignition off. Remove the Viscous Heater Relay from the PDC. Disconnect the ECM harness connectors. Measure the resistance of the Viscous Heater Relay Control circuit. Is the resistance below 10.0 ohms?  Yes → Replace and program the Engine Control Module in accordance with the Service Information. Perform ROAD TEST VERIFICATION - VER-2.  No → Repair the Viscous Heater Relay Control circuit for an open. Perform ROAD TEST VERIFICATION - VER-2.	All

**Symptom List:**

**P1651-MIL/DIAG LAMP VIA J1850 BUS IN FRAME RESPONSE ERROR**

**P1651-MIL/DIAG LAMP VIA J1850 BUS STATUS ERROR**

**Test Note: All symptoms listed above are diagnosed using the same tests. The title for the tests will be P1651-MIL/DIAG LAMP VIA J1850 BUS IN FRAME RESPONSE ERROR.**

**When Monitored and Set Condition:**

**P1651-MIL/DIAG LAMP VIA J1850 BUS IN FRAME RESPONSE ERROR**

When Monitored: With the ignition on.

Set Condition: The ECM does not receive a response from the instrument cluster when a J1850 message to actuate the MIL is transmitted.

**P1651-MIL/DIAG LAMP VIA J1850 BUS STATUS ERROR**

When Monitored: With the ignition on.

Set Condition: The ECM MIL status does not agree with the instrument cluster MIL status.

**POSSIBLE CAUSES**

REFER TO COMMUNICATION SECTION  
 VERIFY INSTRUMENT CLUSTER COMMUNICATION  
 INTERMITTENT CONDITION

TEST	ACTION	APPLICABILITY
1	Turn the ignition on. With the DRBIII®, erase the ECM DTCs. Cycle the ignition switch from OFF to ON. Monitor the DRBIII® for ECM DTCs. Does the DRBIII® display this DTC?  Yes → Go To 2 No → Go To 3	All

**P1651-MIL/DIAG LAMP VIA J1850 BUS IN FRAME RESPONSE ERROR — Continued**

TEST	ACTION	APPLICABILITY
2	<p>Start and idle the engine.                      With the DRBIII®, select Instrument Cluster and read the PCM/ECM Monitors.  <b>NOTE: If the DRB is unable to communicate with the Instrument cluster, refer to the appropriate symptom in the Body Diagnostic Information</b>                      Does the DRB display accurate monitors?</p> <p>Yes → [007f]Replace and program the Engine Control Module in accordance with the Service Information.                      Perform ROAD TEST VERIFICATION - VER-2.</p> <p>No → Refer to Body Diagnostic Information for problems related to Communication with ECM.                      Perform ROAD TEST VERIFICATION - VER-2.</p>	All
3	<p><b>WARNING: WHEN THE ENGINE IS OPERATING, DO NOT STAND IN A DIRECT LINE WITH THE FAN. DO NOT PUT YOUR HANDS NEAR THE PULLEYS, BELTS OR FAN. DO NOT WEAR LOOSE CLOTHING.</b>  <b>NOTE: The conditions that set the DTC are not present at this time. The following list may help in identifying the intermittent condition.</b>                      With the engine running at normal operating temperature, monitor the DRB parameters related to the DTC while wiggling the wiring harness. Look for parameter values to change and/or a DTC to set.                      Review the DTC When Monitored and Set Conditions. If possible, try to duplicate the conditions under which the DTC was set.                      Refer to any Technical Service Bulletins (TSB) that may apply.                      Visually inspect the related wiring harness. Look for any chafed, pierced, pinched, or partially broken wires.                      Visually inspect the related wiring harness connectors. Look for broken, bent, pushed out, or corroded terminals.                      Were any of the above conditions present?</p> <p>Yes → Repair as necessary.                      Perform ROAD TEST VERIFICATION - VER-2.</p> <p>No → Test Complete.</p>	All

**Symptom List:**

**P1652-J1850 COMMUNICATION BUS LOST ARBITRATION**  
**P1652-J1850 COMMUNICATION BUS RECEIVE TIMEOUT**  
**P1652-J1850 COMMUNICATION BUS SHORT TO GROUND**  
**P1652-J1850 COMMUNICATION BUS SHORT TO VOLTAGE**  
**P1652-J1850 COMMUNICATION BUS SPI ERROR**  
**P1652-J1850 COMMUNICATION BUS TRANSMIT BUFFER OVER-**  
**RUN**  
**P1652-J1850 COMMUNICATION BUS UNAUTHORIZED RESET**

---

**Test Note: All symptoms listed above are diagnosed using the same tests. The title for the tests will be P1652-J1850 COMMUNICATION BUS LOST ARBITRATION.**

---

**When Monitored and Set Condition:**

**P1652-J1850 COMMUNICATION BUS LOST ARBITRATION**

When Monitored: With the ignition on.

Set Condition: A J1850 Bus error occurred while the ECM was sending a message.

**P1652-J1850 COMMUNICATION BUS RECEIVE TIMEOUT**

When Monitored: With the ignition on.

Set Condition: The ECM has not received a J1850 Bus message for 2.0 seconds.

**P1652-J1850 COMMUNICATION BUS SHORT TO GROUND**

When Monitored: With the ignition on.

Set Condition: The ECM detects continuous low voltage on the J1850 Bus circuit.

**P1652-J1850 COMMUNICATION BUS SHORT TO VOLTAGE**

When Monitored: With the ignition on.

Set Condition: The ECM detects continuous high voltage on the J1850 Bus circuit.

**P1652-J1850 COMMUNICATION BUS SPI ERROR**

When Monitored: With the ignition on.

Set Condition: The ECM has detected an internal communication problem.

**P1652-J1850 COMMUNICATION BUS TRANSMIT BUFFER OVERRUN**

When Monitored: With the ignition on.

Set Condition: The ECM has detected an internal problem.

**P1652-J1850 COMMUNICATION BUS LOST ARBITRATION — Continued**

**P1652-J1850 COMMUNICATION BUS UNAUTHORIZED RESET**

When Monitored: With the ignition on.

Set Condition: An unauthorized reset of the J1850 hardware occurs during normal operation.

**POSSIBLE CAUSES**

VERIFY ACTIVE DTC  
 VERIFY INSTRUMENT CLUSTER COMMUNICATION  
 INTERMITTENT CONDITION

TEST	ACTION	APPLICABILITY
1	Turn the ignition on. With the DRBIII® attempt to communicate with the Instrument Cluster. Is the Instrument Cluster communicating with the DRB?  Yes → Go To 2  No → Refer to the appropriate symptom in the Body Diagnostic Information. Perform ROAD TEST VERIFICATION - VER-2.	All
2	Turn the ignition on. With the DRBIII®, erase the ECM DTCs. Turn the ignition off then turn the ignition on and wait 60 seconds. With the DRBIII®, read the ECM DTCs. Does the DRB display this DTC?  Yes → Replace and program the Engine Control Module in accordance with the Service Information. Perform ROAD TEST VERIFICATION - VER-2.  No → Go To 3	All

**P1652-J1850 COMMUNICATION BUS LOST ARBITRATION — Continued**

TEST	ACTION	APPLICABILITY
3	<p><b>WARNING: WHEN THE ENGINE IS OPERATING, DO NOT STAND IN A DIRECT LINE WITH THE FAN. DO NOT PUT YOUR HANDS NEAR THE PULLEYS, BELTS OR FAN. DO NOT WEAR LOOSE CLOTHING.</b></p> <p><b>NOTE: The conditions that set the DTC are not present at this time. The following list may help in identifying the intermittent condition.</b></p> <p>With the engine running at normal operating temperature, monitor the DRB parameters related to the DTC while wiggling the wiring harness. Look for parameter values to change and/or a DTC to set.</p> <p>Review the DTC When Monitored and Set Conditions. If possible, try to duplicate the conditions under which the DTC was set.</p> <p>Refer to any Technical Service Bulletins (TSB) that may apply.</p> <p>Visually inspect the related wiring harness. Look for any chafed, pierced, pinched, or partially broken wires.</p> <p>Visually inspect the related wiring harness connectors. Look for broken, bent, pushed out, or corroded terminals.</p> <p>Were any of the above conditions present?</p> <p>Yes → Repair as necessary. Perform ROAD TEST VERIFICATION - VER-2.</p> <p>No → Test Complete.</p>	All



**Symptom:**

**P1685-SKIM SYSTEM INVALID KEY CODE RECEIVED**

---

**When Monitored and Set Condition:**

**P1685-SKIM SYSTEM INVALID KEY CODE RECEIVED**

When Monitored: With the ignition on.

Set Condition: The ECM receives a message from the SKIM indicating an incorrect message was received from the ignition key.

**POSSIBLE CAUSES**

SKIM/IGNITION KEY FAULT

TEST	ACTION	APPLICABILITY
1	This fault indicates a SKIS problem. View repair.  Yes → Refer to SKIS information for the related symptom(s). Perform ROAD TEST VERIFICATION - VER-2.	All

**Symptom:**

**P1685-SKIM SYSTEM KEY COMMUNICATION TIMED OUT**

**When Monitored and Set Condition:**

**P1685-SKIM SYSTEM KEY COMMUNICATION TIMED OUT**

When Monitored: With the ignition on.

Set Condition: Communication between the ECM and the SKIM is not completed within 2.0 seconds

**POSSIBLE CAUSES**

SKIM  
 INTERMITTENT CONDITION  
 CHECK FOR SKIM COMMUNICATION AND DTCS  
 ENGINE CONTROL MODULE

TEST	ACTION	APPLICABILITY
1	Turn the ignition on. With the DRB, check for Sentry Key Immobilizer Module communication and DTCS. Are any SKIS problems or DTCS present?  Yes → Refer to symptom list for problems related to SKIM Communication and DTCS before continuing. Perform ROAD TEST VERIFICATION - VER-2.  No → Go To 2	All
2	Turn the ignition on. With the DRBIII®, erase ECM DTCS. Turn the ignition on and off several times pausing 10 seconds between each key cycle. With the DRBIII®, read the ECM DTCS. Are any P1685 DTCS present?  Yes → Go To 3  No → Go To 4	All
3	Replace and program the SKIM in accordance with the Service Information. Turn the ignition on. With the DRBIII®, erase ECM DTCS. Turn the ignition on and off several times pausing for 10 seconds between key cycles. With the DRBIII®, read ECM DTCS. Are there any P1685 DTCS present?  Yes → Replace and program the Engine Control Module in accordance with the Service Information. Perform ROAD TEST VERIFICATION - VER-2.  No → The test is complete. Perform ROAD TEST VERIFICATION - VER-2.	All

**P1685-SKIM SYSTEM KEY COMMUNICATION TIMED OUT — Continued**

TEST	ACTION	APPLICABILITY
4	<p><b>WARNING: WHEN THE ENGINE IS OPERATING, DO NOT STAND IN A DIRECT LINE WITH THE FAN. DO NOT PUT YOUR HANDS NEAR THE PULLEYS, BELTS OR FAN. DO NOT WEAR LOOSE CLOTHING.</b></p> <p><b>NOTE: The conditions that set the DTC are not present at this time. The following list may help in identifying the intermittent condition.</b></p> <p>With the engine running at normal operating temperature, monitor the DRB parameters related to the DTC while wiggling the wiring harness. Look for parameter values to change and/or a DTC to set.</p> <p>Review the DTC When Monitored and Set Conditions. If possible, try to duplicate the conditions under which the DTC was set.</p> <p>Refer to any Technical Service Bulletins (TSB) that may apply.</p> <p>Visually inspect the related wiring harness. Look for any chafed, pierced, pinched, or partially broken wires.</p> <p>Visually inspect the related wiring harness connectors. Look for broken, bent, pushed out, or corroded terminals.</p> <p>Were any of the above conditions present?</p> <p style="padding-left: 40px;">Yes → Repair as necessary. Perform ROAD TEST VERIFICATION - VER-2.</p> <p style="padding-left: 40px;">No → Test Complete.</p>	All

**Symptom List:**

**P2120-ACC PEDAL POSITION SENSOR 1 CKT PLAUSIBILITY**  
**P2120-ACC PEDAL POSITION SENSOR 1 CKT PLAUSIBILITY WITH BRAKE SWITCH**  
**P2120-ACC PEDAL POSITION SENSOR 1 CKT SIGNAL VOLTAGE TOO HIGH**  
**P2120-ACC PEDAL POSITION SENSOR 1 CKT SIGNAL VOLTAGE TOO LOW**  
**P2120-ACC PEDAL POSITION SENSOR 1 CKT SUPPLY VOLTAGE TOO HIGH OR LOW**  
**P2125-ACC PEDAL POSITION SENSOR 2 CIRCUIT PLAUSIBILITY (WITH SENSOR 1 CIRCUIT)**  
**P2125-ACC PEDAL POSITION SENSOR 2 CKT SIGNAL VOLTAGE TOO HIGH**  
**P2125-ACC PEDAL POSITION SENSOR 2 CKT SUPPLY VOLTAGE TOO HIGH OR LOW**

---

**Test Note: All symptoms listed above are diagnosed using the same tests. The title for the tests will be P2120-ACC PEDAL POSITION SENSOR 1 CKT PLAUSIBILITY.**

---

**When Monitored and Set Condition:****P2120-ACC PEDAL POSITION SENSOR 1 CKT PLAUSIBILITY**

When Monitored: With the ignition on.

Set Condition: The Accelerator Pedal Position Sensor Signal is below 1.6% or above 17.6% and the idle switch is not in the correct state. NOTE: The idle switch is designed to transition when the accel position is approximately 16% (1.00 volt). This code sets the ECM to Limp-in Mode, which includes a fixed engine speed of 1100 RPM.

**P2120-ACC PEDAL POSITION SENSOR 1 CKT PLAUSIBILITY WITH BRAKE SWITCH**

When Monitored: With the engine speed above 700 rpm.

Set Condition: The ECM detects the Accelerator Pedal and the Brake Pedal have been depressed at the same time for longer than 5.0 seconds.

**P2120-ACC PEDAL POSITION SENSOR 1 CKT SIGNAL VOLTAGE TOO HIGH**

When Monitored: With the ignition on.

Set Condition: The ECM detects voltage on the Accelerator Pedal Position Sensor Signal circuit above 4.5 volts.

**P2120-ACC PEDAL POSITION SENSOR 1 CKT PLAUSIBILITY — Continued**

---

**P2120-ACC PEDAL POSITION SENSOR 1 CKT SIGNAL VOLTAGE TOO LOW**

When Monitored: With the ignition on.

Set Condition: The ECM detects voltage on the Accelerator Pedal Position Sensor Signal circuit 0.0 volt.

**P2120-ACC PEDAL POSITION SENSOR 1 CKT SUPPLY VOLTAGE TOO HIGH OR LOW**

When Monitored: With the ignition on.

Set Condition: The Accelerator Pedal Position Sensor 5-Volt Supply voltage is above 5.1 volts or below 4.9 volts.

**P2125-ACC PEDAL POSITION SENSOR 2 CIRCUIT PLAUSIBILITY (WITH SENSOR 1 CIRCUIT)**

When Monitored: With the ignition on.

Set Condition: The ECM determines that the APP Sensor #1 and APP Sensor #2 signals do not agree.

**P2125-ACC PEDAL POSITION SENSOR 2 CKT SIGNAL VOLTAGE TOO HIGH**

When Monitored: With the ignition on.

Set Condition: The ECM detects voltage on the Accelerator Pedal Position Sensor Signal circuit above 3.3 volts.

**P2125-ACC PEDAL POSITION SENSOR 2 CKT SUPPLY VOLTAGE TOO HIGH OR LOW**

When Monitored: With the ignition on.

Set Condition: The Accelerator Pedal Position Sensor 5-Volt Supply voltage is above 5.1 volts or below 4.9 volts.

**POSSIBLE CAUSES**

ACCELERATOR PEDAL POSITION SENSOR

ECM - 5-VOLT SUPPLY CIRCUIT

SENSOR GROUND OPEN (APP SENSOR)

INTERMITTENT CONDITION

5-VOLT SUPPLY OR SENSOR REFERENCE VOLTAGE A CIRCUIT OPEN

APP SENSOR SIGNAL CIRCUIT OPEN

5-VOLT SUP OR SENSOR REF VOLTAGE A CIRCUIT SHORTED TO THE SENSOR GROUND CIRCUIT

APP SENSOR SIGNAL CIRCUIT SHORTED TO GROUND

5-VOLT SUPPLY OR SENSOR REF VOLTAGE A CIRCUIT SHORTED TO GROUND

**P2120-ACC PEDAL POSITION SENSOR 1 CKT PLAUSIBILITY — Continued****POSSIBLE CAUSES**

VERIFY APP SENSOR OPERATION

APP SENSOR SIGNAL CIRCUIT SHORTED TO THE SENSOR GROUND CIRCUIT  
5-VOLT SUPPLY OR SENSOR REF VOLTAGE A CIRCUIT SHORTED TO VOLTAGE

ECM - SENSOR GROUND OPEN

APP SENSOR CIRCUIT SHORTED TO VOLTAGE

APP SENSOR GROUND CIRCUIT SHORTED TO VOLTAGE

ECM - APP SENSOR SIGNAL CIRCUIT

TEST	ACTION	APPLICABILITY
1	<p><b>NOTE: If DTC P0641 or P0651 is present with this DTC, diagnose DTCs P0641 and P0651 before diagnosing this DTC.</b></p> <p><b>NOTE: The APP Sensor is a device that contains 2 separate potentiometer type sensors. Each sensor has its own 5-volt supply circuit, sensor ground circuit and signal circuit. The APP Sensor no longer incorporates a low-idle switch.</b></p> <p><b>NOTE: The APP Sensor #2 signal should always be 1/2 the voltage of the APP Sensor #1 signal.</b></p> <p>Turn the ignition on. With the DRB, read the APP Sensor #1 and APP Sensor #2 Volts with the accelerator pedal in the at rest position. Does the DRB display between 0.50 and 0.90 volt for sensor #1 and 1/2 the #1 voltage for #2?</p> <p>Yes → Go To 2 No → Go To 5</p>	All
2	<p>Turn the ignition on. Fully depress the accelerator pedal. With the DRB, read the voltage for APP Sensor #1 and APP Sensor #2. Does the DRB display between 4.0 and 4.5 volts for #1 and 1/2 #1 voltage for #2?</p> <p>Yes → Go To 3 No → Go To 5</p>	All
3	<p>Turn the ignition on. With the DRB, read the APP Sensor #1 and APP Sensor #2 percentages (%). With the accelerator pedal in the idle position, slowly depress the accelerator pedal until the pedal is fully depressed. <b>NOTE: The percentage readings for APP Sensor #1 and #2 should increase smoothly as the pedal is depressed.</b> Does the percentage increase smoothly for both readings with the accelerator pedal travel?</p> <p>Yes → Go To 4 No → Replace the Accelerator Pedal Position Sensor in accordance with the Service Information. Perform ROAD TEST VERIFICATION - VER-2.</p>	All

**P2120-ACC PEDAL POSITION SENSOR 1 CKT PLAUSIBILITY — Continued**

TEST	ACTION	APPLICABILITY
4	<p><b>WARNING: WHEN THE ENGINE IS OPERATING, DO NOT STAND IN A DIRECT LINE WITH THE FAN. DO NOT PUT YOUR HANDS NEAR THE PULLEYS, BELTS OR FAN. DO NOT WEAR LOOSE CLOTHING.</b></p> <p><b>NOTE: The conditions that set the DTC are not present at this time. The following list may help in identifying the intermittent condition.</b></p> <p>With the engine running and at normal operating temperature, monitor the DRB parameters related to the DTC while wiggling the wiring harness. Look for parameter values to change and/or a DTC to set.</p> <p>Review the DTC When Monitored and Set Conditions. If possible, try to duplicate the conditions under which the DTC was set by slowly pressing and releasing the accelerator pedal several times.</p> <p>Refer to any Technical Service Bulletins (TSB) that may apply.</p> <p>Visually inspect the related wiring harness. Look for any chafed, pierced, pinched, or partially broken wires.</p> <p>Visually inspect the related wiring harness connectors. Look for broken, bent, pushed out, or corroded terminals.</p> <p>Were any of the above conditions present?</p> <p style="padding-left: 40px;">Yes → Repair as necessary. Perform ROAD TEST VERIFICATION - VER-2.</p> <p style="padding-left: 40px;">No → Test Complete.</p>	All
5	<p><b>NOTE: Perform the rest of this diagnostic procedure on the individual APP Sensor Potentiometer (#1 or #2) that did not display the correct voltages in the previous test.</b></p> <p>Turn the ignition off.</p> <p>Disconnect the APP Sensor harness connector.</p> <p>Turn the ignition on.</p> <p>Measure the voltage of the 5-volt Supply (Sensor Reference Voltage A on Sensor #2) circuit in APP Sensor harness connector.</p> <p>Is the voltage between 4.7 and 5.3 volts?</p> <p style="padding-left: 40px;">Yes → Go To 6</p> <p style="padding-left: 40px;">No → Go To 14</p>	All
6	<p>Turn the ignition off.</p> <p>Disconnect the APP Sensor harness connector.</p> <p>Connect a jumper wire between APP Sensor Signal circuit and the 5-volt supply circuit at the APP Sensor harness connector .</p> <p>With the DRB, read the PEDAL OUTPUT VOLTS.</p> <p>Does the DRB display between 4.0 and 5.5 volts?</p> <p style="padding-left: 40px;">Yes → Go To 7</p> <p style="padding-left: 40px;">No → Go To 10</p>	All
7	<p>Turn the ignition off.</p> <p>Disconnect the APP Sensor harness connector.</p> <p>Disconnect the ECM harness connectors.</p> <p>Remove the ASD Relay from the PDC.</p> <p>Connect a jumper wire between cavity 30 and cavity 87 of the ASD Relay connector.</p> <p>Turn the ignition on.</p> <p>Measure the voltage of the APP Sensor Ground circuit.</p> <p>Is the voltage above 1.0 volt?</p> <p style="padding-left: 40px;">Yes → Repair the App Sensor Ground circuit for a short to voltage. Perform ROAD TEST VERIFICATION - VER-2.</p> <p style="padding-left: 40px;">No → Go To 8</p>	All

**P2120-ACC PEDAL POSITION SENSOR 1 CKT PLAUSIBILITY — Continued**

TEST	ACTION	APPLICABILITY
8	Turn the ignition off. Disconnect the APP Sensor harness connector. Disconnect the ECM harness connectors. Measure the resistance of the Sensor Ground circuit between the APP Sensor and the ECM. Is the resistance below 10.0 ohms?  Yes → Go To 9  No → Repair the APP Sensor Ground circuit for an open. Perform ROAD TEST VERIFICATION - VER-2.	All
9	Turn the ignition off. Disconnect the APP Sensor harness connector. Using a 12-volt test light connected to 12-volts, check the Sensor ground circuit of the appropriate potentiometer. Does the test light illuminate brightly?  Yes → Replace the Accelerator Pedal Position Sensor. Perform ROAD TEST VERIFICATION - VER-2.  No → Replace and program the Engine Control Module in accordance with the Service Information. Perform ROAD TEST VERIFICATION - VER-2.	All
10	Turn the ignition off. Disconnect the APP Sensor harness connector. Disconnect the ECM harness connectors. Measure the resistance of the APP Sensor Signal circuit. Is the resistance below 10.0 ohms?  Yes → Go To 11  No → Repair the APP Sensor Signal circuit for an open Perform ROAD TEST VERIFICATION - VER-2.	All
11	Turn the ignition off. Disconnect the APP Sensor harness connector. Disconnect the ECM harness connectors. Measure the resistance between ground and the APP Sensor Signal circuit. Is the resistance below 1000 ohms?  Yes → Repair the APP Sensor Signal circuit for a short to ground. Perform ROAD TEST VERIFICATION - VER-2.  No → Go To 12	All
12	Turn the ignition off. Disconnect the APP Sensor harness connector. Disconnect the ECM harness connectors. Measure the resistance between the APP Sensor Signal circuit and the Sensor Ground circuit at of the APP Sensor harness connector. Is the resistance below 1000 ohms?  Yes → Repair the APP Sensor Signal and Sensor Ground circuits for a short together. Perform ROAD TEST VERIFICATION - VER-2.  No → Go To 13	All



**P2120-ACC PEDAL POSITION SENSOR 1 CKT PLAUSIBILITY — Continued**

TEST	ACTION	APPLICABILITY
13	Turn the ignition off. Disconnect the APP Sensor harness connector. Disconnect the ECM harness connectors. Remove the ASD Relay from the PDC. Connect a jumper wire between cavity 30 and cavity 87 of the ASD Relay connector. Turn the ignition on. Measure the voltage of the APP Sensor Signal circuit. Is the voltage above 1.0 volt?  Yes → Repair the APP Sensor Signal circuit for a short to voltage. Perform ROAD TEST VERIFICATION - VER-2.  No → Replace and program the Engine Control Module in accordance with the Service Information. Perform ROAD TEST VERIFICATION - VER-2.	All
14	Turn the ignition off. Disconnect the APP Sensor harness connector. Disconnect the ECM harness connectors. Measure the resistance of the 5-volt Supply (Sensor Reference Voltage A on Sensor #2) circuit. Is the resistance below 10.0 ohms?  Yes → Go To 15  No → Repair the 5-volt Supply (Sensor Reference Voltage A on Sensor #2) circuit for an open. Perform ROAD TEST VERIFICATION - VER-2.	All
15	Turn the ignition off. Disconnect the APP Sensor harness connector. Disconnect the ECM harness connectors. Measure the resistance between the 5-volt Supply (Sensor Reference Voltage A on Sensor #2) circuit and the Sensor Ground circuit at the APP Sensor harness connector. Is the resistance above 1000 ohms?  Yes → Go To 16  No → Repair the 5-volt Supply (Sensor Reference Voltage A on Sensor #2) circuit for a short to the Sensor Ground circuit. Perform ROAD TEST VERIFICATION - VER-2.	All
16	Turn the ignition off. Disconnect the APP Sensor harness connector. Disconnect the ECM harness connectors. Measure the resistance between ground and the 5-volt Supply (Sensor Reference Voltage A on Sensor #2) circuit. Is the resistance below 1000 ohms?  Yes → Repair the 5-volt Supply (Sensor Reference Voltage A on Sensor #2) circuit for a short to ground. Perform ROAD TEST VERIFICATION - VER-2.  No → Go To 17	All

**P2120-ACC PEDAL POSITION SENSOR 1 CKT PLAUSIBILITY — Continued**

TEST	ACTION	APPLICABILITY
17	<p>Turn the ignition off.            Disconnect the APP Sensor harness connector.            Disconnect the ECM harness connectors.            Remove the ASD Relay from the PDC.            Connect a jumper wire between cavity 30 and cavity 87 of the ASD Relay connector.            Turn the ignition on.            Measure the voltage of the 5-volt Supply (Sensor Reference Voltage A on Sensor #2) circuit in the ECM harness connector.            Is the voltage above 1.0 volt?</p> <p>Yes → Repair the 5-volt Supply (Sensor Reference Voltage A on Sensor #2) circuit for a short to voltage.            Perform ROAD TEST VERIFICATION - VER-2.</p> <p>No → Replace and program the Engine Control Module in accordance with the Service Information.            Perform ROAD TEST VERIFICATION - VER-2.</p>	All

## Symptom:

### \*A/C INOPERATIVE

#### POSSIBLE CAUSES

CHECK FOR ECM DTCS  
 FUSED B+ CIRCUIT OPEN  
 A/C CLUTCH RELAY  
 A/C CLUTCH RELAY OUTPUT CIRCUIT SHORTED TO GROUND  
 A/C CLUTCH RELAY OUTPUT CIRCUIT OPEN  
 A/C CLUTCH GROUND CIRCUIT OPEN  
 A/C CLUTCH  
 ECM - INTERNAL FAULT  
 AZC MODULE OR A/C - HEATER CONTROL MODULE  
 BCM - NO SWITCH STATE CHANGE  
 A/C SWITCH SIGNAL CIRCUIT OPEN  
 BCM - ON/OFF CONTROL CIRCUIT OPEN

TEST	ACTION	APPLICABILITY
1	<p><b>NOTE: Ensure that the refrigerant system is properly charged. Refer to the appropriate Service Information.</b>                      With the DRBIII®, check for ECM DTCS.                      Are any DTCs present?</p> <p>Yes → Return to the symptom list and choose the symptom(s).                      Perform ROAD TEST VERIFICATION - VER-2.</p> <p>No → Go To 2</p>	All
2	<p>Turn the ignition on.                      Position the Mode switch on the AZC Module or the A/C - Heater Control Module to the Panel position.                      Turn the A/C Select switch off.                      With the DRBIII® in BCM, select Inputs/Outputs.                      Monitor the A/C Select Switch state while turning the A/C Select switch from off to on and then back to off.                      Does the switch state change from Off to On and then back to Off?</p> <p>Yes → Go To 3</p> <p>No → Go To 10</p>	All
3	<p>Turn the ignition on.                      With the DRBIII®, actuate the A/C Compressor Clutch Relay.                      Observe the A/C Compressor Clutch during actuation.                      Is the A/C Compressor Clutch clicking?</p> <p>Yes → Replace and program the ECM in accordance with the Service Information.                      Perform ROAD TEST VERIFICATION - VER-2.</p> <p>No → Go To 4</p>	All

**\*A/C INOPERATIVE — Continued**

TEST	ACTION	APPLICABILITY
4	<p><b>NOTE: If the A/C Clutch fuse is open, refer to the system schematics for all circuits that are powered by the A/C Clutch fuse to determine the cause of the blown fuse.</b></p> <p>Turn the ignition off.  Remove the A/C Clutch Relay from the PDC.  Using a 12-volt test light connected to ground, probe the Fused B+ circuit in the PDC.  Does the test light illuminate brightly?</p> <p>Yes → Go To 5</p> <p>No → Repair the Fused B+ circuit. Inspect fuse and replace as necessary.  Perform ROAD TEST VERIFICATION - VER-2.</p>	All
5	<p>Turn the ignition off.  Install a substitute relay in place of the A/C Clutch Relay.  Turn the ignition on.  With the DRBIII®, actuate the A/C Clutch Relay.  Does the A/C Clutch Relay cycle on and off?</p> <p>Yes → Replace the A/C Clutch Relay.  Perform ROAD TEST VERIFICATION - VER-2.</p> <p>No → Go To 6</p>	All
6	<p>Turn the ignition off.  Remove the A/C Clutch Relay from the PDC.  Disconnect the A/C Clutch harness connector.  Measure the resistance between ground and the A/C Clutch Relay Output circuit.  Is the resistance above 100 kohms?</p> <p>Yes → Go To 7</p> <p>No → Repair the A/C Clutch Relay Output circuit for a short to ground.  Inspect fuse and replace as necessary.  Perform ROAD TEST VERIFICATION - VER-2.</p>	All
7	<p>Turn the ignition off.  Remove the A/C Clutch Relay from the PDC.  Disconnect the A/C Clutch harness connector.  Measure the resistance of the A/C Clutch Relay Output circuit.  Is the resistance below 5.0 ohms?</p> <p>Yes → Go To 8</p> <p>No → Repair the A/C Clutch Relay Output circuit for an open.  Perform ROAD TEST VERIFICATION - VER-2.</p>	All
8	<p>Turn the ignition off.  Disconnect the A/C Clutch harness connector.  Using a 12-volt test light connected to 12-volts, check the A/C Clutch Ground circuit.  Does the test light illuminate brightly?</p> <p>Yes → Go To 9</p> <p>No → Repair the A/C Clutch Ground circuit for an open.  Perform ROAD TEST VERIFICATION - VER-2.</p>	All

## \*A/C INOPERATIVE — Continued

TEST	ACTION	APPLICABILITY
9	<p>If there are no possible causes remaining, view repair.</p> <p>Repair</p> <p>Replace the A/C Clutch in accordance with the Service Information.</p> <p>Perform ROAD TEST VERIFICATION - VER-2.</p>	All
10	<p>Turn the ignition off.</p> <p>Disconnect the AZC Module C2 harness connector or the A/C - Heater Control C1 harness connector.</p> <p>Turn the ignition on.</p> <p>Measure the voltage of the A/C Switch Signal circuit.</p> <p>Is the voltage greater than 11.0 volts?</p> <p>Yes → Go To 11</p> <p>No → Go To 12</p>	All
11	<p>Turn the ignition off.</p> <p>Disconnect the AZC Module C2 harness connector or the A/C - Heater Control C1 harness connector.</p> <p>Turn the ignition on.</p> <p>With the DRBIII® in BCM, select Inputs/Outputs.</p> <p>Monitor the A/C Select Switch state while connecting a jumper wire between ground and the A/C Switch Signal circuit in the AZC Module C2 harness connector or the A/C - Heater Control C1 harness connector.</p> <p>Does the A/C Select Switch state change from Off to On when the jumper wire is connected?</p> <p>Yes → Replace the AZC Module or the A/C - Heater Control Module in accordance with the Service Information.</p> <p>Perform BODY VERIFICATION TEST - VER 1.</p> <p>No → Replace and program the Body Control Module in accordance with the Service Information.</p> <p>Perform BODY VERIFICATION TEST - VER 1.</p>	All
12	<p>Turn the ignition off.</p> <p>Disconnect the BCM C1 harness connector.</p> <p>Disconnect the AZC Module C2 harness connector or the A/C - Heater Control C1 harness connector.</p> <p>Measure the resistance of the A/C Switch Signal circuit between the AZC Module C2 harness connector or the A/C - Heater Control C1 harness connector and the BCM C1 harness connector.</p> <p>Is the resistance below 5.0 ohms?</p> <p>Yes → Replace and program the Body Control Module in accordance with the Service Information.</p> <p>Perform BODY VERIFICATION TEST - VER 1.</p> <p>No → Repair the A/C Switch Signal circuit for an open.</p> <p>Perform BODY VERIFICATION TEST - VER 1.</p>	All

**Symptom:**

**\*A/C OPERATES IN ALL MODE SWITCH POSITIONS**

POSSIBLE CAUSES
CHECK FOR ECM DTCS
A/C CLUTCH
A/C CLUTCH RELAY OUTPUT CIRCUIT SHORTED TO VOLTAGE
A/C CLUTCH RELAY
ENGINE CONTROL MODULE
A/C SWITCH SIGNAL CIRCUIT SHORTED TO GROUND
AZC MODULE OR A/C - HEATER CONTROL MODULE
BODY CONTROL MODULE

TEST	ACTION	APPLICABILITY
1	With the DRBIII®, check for ECM DTCs. Are any DTCs present?  Yes → Return to the symptom list and choose the symptom(s). Perform ROAD TEST VERIFICATION - VER-2.  No → Go To 2	All
2	Turn the ignition on. Position the Mode switch on the AZC Module or the A/C - Heater Control Module to the Panel position. Turn the A/C Select switch off. With the DRBIII® in BCM, select Inputs/Outputs. Monitor the A/C Select Switch state while turning the A/C Select switch from off to on and then back to off. Does the switch state change from Off to On and then back to Off?  Yes → Go To 3  No → Go To 6	All
3	Turn the ignition off. Disconnect the A/C Clutch harness connector. <b>WARNING: WHEN THE ENGINE IS OPERATING, DO NOT STAND IN A DIRECT LINE WITH THE FAN. DO NOT PUT YOUR HANDS NEAR THE PULLEYS, BELTS OR FAN. DO NOT WEAR LOOSE CLOTHING.</b> Start the engine and observe the A/C Clutch and Compressor. Does the A/C Compressor run with the harness connector disconnected?  Yes → Replace the A/C Clutch in accordance with the Service Information. Perform ROAD TEST VERIFICATION - VER-2.  No → Go To 4	All

**\*A/C OPERATES IN ALL MODE SWITCH POSITIONS — Continued**

TEST	ACTION	APPLICABILITY
4	<p>Turn the ignition off.                      Remove the A/C Clutch Relay from the PDC.                      Disconnect the A/C Clutch harness connector.                      Turn the ignition on.                      Measure the voltage of the A/C Clutch Relay Output circuit.                      Is the voltage above 1.0 volt?</p> <p>Yes → Repair the A/C Clutch Relay Output circuit for a short to voltage.                      Perform ROAD TEST VERIFICATION - VER-2.</p> <p>No → Go To 5</p>	All
5	<p>Turn the ignition off.                      Install a substitute relay in place of the A/C Clutch Relay.                      Turn the ignition on.                      With the DRBIII®, actuate the A/C Clutch Relay.                      Does the A/C Clutch Relay cycle on and off?</p> <p>Yes → Replace the A/C Clutch Relay.                      Perform ROAD TEST VERIFICATION - VER-2.</p> <p>No → Replace and program the Engine Control Module in accordance with the Service Information.                      Perform ROAD TEST VERIFICATION - VER-2.</p>	All
6	<p>Turn the ignition off.                      Disconnect the BCM C2 harness connector.                      Disconnect the AZC Module C2 harness connector or the A/C - Heater Control C1 harness connector.                      Measure the resistance of the A/C Switch Signal circuit between the AZC Module C2 harness connector or the A/C - Heater Control C1 harness connector and ground.                      Is the resistance below 100K ohms?</p> <p>Yes → Repair the A/C Switch Signal Circuit for a short to ground.                      Perform BODY VERIFICATION TEST - VER 1.</p> <p>No → Go To 7</p>	All
7	<p>Turn the ignition off.                      Make sure that the BCM harness connectors are connected to the BCM.                      Disconnect the AZC Module C2 harness connector or the A/C - Heater Control C1 harness connector.                      Turn the ignition on.                      With the DRBIII® in BCM, select Inputs/Outputs.                      Monitor the A/C Select Switch state while connecting a jumper wire between ground and the A/C Switch Signal circuit in the AZC Module C2 harness connector or the A/C - Heater Control C1 harness connector.                      Does the A/C Select Switch state change from Off to On when the jumper wire is connected?</p> <p>Yes → Replace the AZC Module or the A/C - Heater Control Module in accordance with the Service Information.                      Perform BODY VERIFICATION TEST - VER 1.</p> <p>No → Replace and program the Body Control Module in accordance with the Service Information.                      Perform BODY VERIFICATION TEST - VER 1.</p>	All

**Symptom:****\*CHECKING THE ACCELERATOR PEDAL POSITION SENSOR CALIBRATION****POSSIBLE CAUSES**

APP SENSOR IDLE VOLTAGE

APP SENSOR WIDE OPEN THROTTLE VOLTAGE

VERIFY APP SENSOR OPERATION

TEST	ACTION	APPLICABILITY
1	<p><b>NOTE: The APP Sensor is a device that contains 2 separate potentiometer type sensors. Each sensor receives it's own 5-volt supply circuit, sensor ground circuit and signal circuit. The APP Sensor no longer incorporates a low-idle switch.</b></p> <p><b>NOTE: The APP Sensor #2 signal should always be 1/2 the voltage as the APP Sensor #1 signal</b></p> <p>Turn the ignition on.            With the DRB, read the APP Sensor #1 and APP Sensor #2 Volts with the accelerator pedal in the at rest position.            Does the DRB display between 0.50 and 0.90 volt for sensor #1 and 1/2 the #1 voltage for #2?</p> <p>Yes → Go To 2</p> <p>No → Replace the Accelerator Pedal Position Sensor.            Perform ROAD TEST VERIFICATION - VER-2.</p>	All
2	<p>Turn the ignition on.            Fully depress the accelerator pedal.            With the DRB, read the voltage for APP Sensor #1 and APP Sensor #2.            Does the DRB display between 4.0 and 4.5 volts for #1 and 1/2 #1 voltage for #2?</p> <p>Yes → Go To 3</p> <p>No → Replace the Accelerator Pedal Position Sensor.            Perform ROAD TEST VERIFICATION - VER-2.</p>	All
3	<p>Turn the ignition on.            With the DRB, read the APP Sensor #1 and APP Sensor #2 percentages (%).            With the accelerator pedal in the idle position, slowly depress the accelerator pedal until the pedal is fully depressed.  <b>NOTE: The percentage readings for APP Sensor #1 and #2 should increase smoothly as the pedal is depressed.</b>            Does the percentage increase smoothly for both readings with the accelerator pedal travel?</p> <p>Yes → Test Complete.</p> <p>No → Replace the Accelerator Pedal Position Sensor.            Perform ROAD TEST VERIFICATION - VER-2.</p>	All



**Symptom:**

**\*CHECKING THE BOOST PRESSURE SENSOR CALIBRATION**

**POSSIBLE CAUSES**

TURBOCHARGER BOOST PRESSURE SENSOR CALIBRATION

TEST	ACTION	APPLICABILITY
1	Allow the engine to idle. With the DRBIII®, select Engine, then Sensors. Read the Boost Pressure Voltage. Is the Boost Pressure Voltage between 1.50 and 2.00 volts?  Yes → Test Complete.  No → Replace the Turbocharger Boost Pressure Sensor. Perform ROAD TEST VERIFICATION - VER-2.	All

**Symptom:**

**\*CHECKING THE ECM POWER AND GROUND CIRCUITS**

POSSIBLE CAUSES
ASD RELAY OUTPUT CIRCUIT(S) OPEN
ECM GROUND CIRCUIT(S) OPEN
FUSED ASD RELAY BATTERY SUPPLY CIRCUIT OPEN
FUSED IGNITION SWITCH OUTPUT CIRCUIT OPEN

TEST	ACTION	APPLICABILITY
1	Turn the ignition off. Disconnect the ECM harness connectors. Using a 12-volt test light connected to 12-volts, check both of the ECM ground circuits in ECM harness connector C1 cavities 1 and 2. Did the test light illuminate for both cavities?  Yes → Go To 2  No → Repair the ECM Ground circuit(s) for an open. Perform ROAD TEST VERIFICATION - VER-2.	All
2	Turn the ignition off. Disconnect the ECM harness connectors. Turn the ignition on. Using a 12-volt test light connected to ground, check the Fused Ignition Switch Output circuit in ECM harness connector C1 cavity 22. Is the test light on?  Yes → Go To 3  No → Repair the Fused Ignition Switch Output circuit for an open. Perform ROAD TEST VERIFICATION - VER-2.	All
3	Turn the ignition off. Remove the ASD Relay from the PDC. Using a 12-volt test light connected to ground, check the Fused ASD Relay Battery Supply circuit in ASD Relay connector cavity 30. Is the test light on?  Yes → Go To 4  No → Repair the Fused ASD Relay Battery Supply circuit for an open. Perform ROAD TEST VERIFICATION - VER-2.	All
4	Turn the ignition off. Disconnect the ECM harness connectors. Remove the ASD Relay from the PDC. Connect a jumper wire between cavity 30 and cavity 87 in the ASD Relay connector. Using a 12-volt test light connected to ground, check the ASD Relay Output circuit in ECM harness connector C1 cavities 4 and 5. Did the test light illuminate for both circuits?  Yes → Test Complete.  No → Repair the ASD Relay Output circuit(s) for an open. Perform ROAD TEST VERIFICATION - VER-2.	All

**Symptom:**

**\*CHECKING THE EGR SYSTEM**

POSSIBLE CAUSES
EGR VALVE CHECKING VACUUM SUPPLY EGR SOLENOID

TEST	ACTION	APPLICABILITY
1	Turn the ignition off. Disconnect both vacuum lines at the EGR Solenoid. Using a vacuum line connection tee, connect the vacuum supply line to the EGR Solenoid Output line at the EGR Solenoid. Disconnect the vacuum line at the EGR Valve. Connect a vacuum gauge to the EGR Solenoid Output line at the EGR Valve. Start the engine. With the engine at idle, note the vacuum gauge reading. Is the vacuum above 22 inches?  Yes → Go To 2  No → Inspect the vacuum hoses/tubes for damage, restriction and leaks. If o.k. refer to the Service Information to check the Vacuum Pump operation. Perform ROAD TEST VERIFICATION - VER-2.	All
2	<b>NOTE: The engine must be at operating temperature for this test to be valid.</b> Turn the ignition off. Disconnect the vacuum line at the EGR Valve. Connect a vacuum gauge to the EGR Solenoid Output line at the EGR Valve Start the engine and observe the vacuum gauge reading for 1 minute. <b>NOTE: The vacuum reading should increase to above 18 inches approximately 5 seconds after the engine is started. The vacuum should decrease to below 4 inches within 40 seconds of engine run time.</b> Did the vacuum reading increase to above 18 inches then decrease below 4 inches as described?  Yes → Go To 3  No → Replace the EGR Solenoid. Perform ROAD TEST VERIFICATION - VER-2.	All
3	Turn the ignition off. Disconnect both vacuum lines at the EGR Solenoid. Using a vacuum line connection tee, connect the vacuum supply line to the EGR Solenoid Output line at the EGR Solenoid. Test drive the vehicle and note the vehicles performance. <b>NOTE: With the connection tee in place the EGR valve will receive full vacuum supply with the engine running. This should cause a severe reduction in engine power.</b> Does the vehicle exhibit a severe loss of power?  Yes → Test Complete.  No → Replace the EGR Valve. Perform ROAD TEST VERIFICATION - VER-2.	All

**Symptom:****\*CHECKING THE ENGINE COOLANT TEMPERATURE SENSOR CALIBRATION****POSSIBLE CAUSES**

ECT SENSOR - COLD

ECT SENSOR - HOT

<b>TEST</b>	<b>ACTION</b>	<b>APPLICABILITY</b>
1	<p><b>NOTE: The thermostat must be operating correctly for this test to be valid.</b> With the DRBIII® in Sensors, read and note the engine coolant temperature. Using a temperature probe, measure the engine block temperature near the ECT Sensor.</p> <p><b>NOTE: The engine temperature should be below 50°C (120°F).</b> Are the readings within 7°C (13°F) of each other?</p> <p>Yes → Go To 2</p> <p>No → Replace the Engine Coolant Temperature Sensor. Perform ROAD TEST VERIFICATION - VER-2.</p>	All
2	<p><b>NOTE: The thermostat must be operating correctly for this test to be valid.</b> Start the engine and bring the engine to operating temperature (thermostat open). Turn the engine off and wait 10 minutes to allow the engine temperature to stabilize. Using a temperature probe, measure the engine block temperature near the ECT Sensor.</p> <p>With the DRBIII®, select Engine, then Sensors and read the engine coolant temperature.</p> <p>Are the readings within 7°C (13°F) of each other?</p> <p>Yes → Test Complete.</p> <p>No → Replace the Engine Coolant Temperature Sensor. Perform ROAD TEST VERIFICATION - VER-2.</p>	All

**Symptom:**

**\*CHECKING THE ENGINE MECHANICAL SYSTEMS**

POSSIBLE CAUSES
CHECKING ENGINE MECHANICAL SYSTEMS

TEST	ACTION	APPLICABILITY
1	<p><b>NOTE: The following items should be checked as a possible cause of a Driveability or No-Start problem.</b></p> <p><b>WARNING: Do not attempt to remove or separate high pressure fuel line. Attempting to do so could result in severe bodily injury or death.</b></p> <p>Engine Valve Timing - must be within specification                      Engine Compression - must be within specifications                      Camshaft Lobes - check for abnormal wear                      Camshaft Position Sensor - check the camshaft position sensor tooth for debris and deterioration                      Crankshaft Position Sensor - check the crankshaft tone wheel for debris and deterioration                      Engine Exhaust System - must be free of any restriction                      Engine Drive Chain and Sprockets - must be properly positioned                      Vacuum System - must operate properly and be free of any vacuum leaks                      Fuel - must have adequate supply and must be free of contamination (ie. debris, water and gasoline)                      Fuel Injectors - must not be plugged or restricted                      Fuel Lift Pump - must operate properly (where applicable)                      Fuel Injection Pump - must be producing the correct output volume and pressure                      Inspect the Fuel Lines, Fuel Filter and Fuel Pressure Relief Valve for signs of restriction and leaks</p> <p><b>NOTE: Check for any Technical Service Bulletins that may relate to the problem.</b></p> <p>Are there any problems evident?</p> <p style="padding-left: 40px;">Yes → Repair as necessary.                      Perform ROAD TEST VERIFICATION - VER-2.</p> <p style="padding-left: 40px;">No → Test Complete.</p>	All

**Symptom:****\*CHECKING THE GLOW PLUG OPERATION****POSSIBLE CAUSES**

CHECKING THE GLOW PLUGS

FUSED B+ CIRCUIT OPEN

GLOW PLUG RELAY OUTPUT CIRCUIT SHORTED TO VOLTAGE

GLOW PLUG RELAY OUTPUT CIRCUIT SHORTED TO GROUND

GLOW PLUG RELAY OUTPUT CIRCUIT OPEN

GLOW PLUG RELAY

TEST	ACTION	APPLICABILITY
1	Turn the ignition off. Disconnect the Glow Plug harness connectors for all cylinders. Turn the ignition on. With the DRBIII®, actuate the Glow Plug 1 Relay. Using a 12-volt test light connected to ground, probe Glow Plug harness connectors 1, 3 and 5 during actuator test. With the DRBIII®, actuate the Glow Plug 2 Relay. Using a 12-volt test light connected to ground, probe Glow Plug harness connectors 2 and 4 during actuator test. Does the test light cycle on and off at each Glow Plug harness connector during actuation?  Yes → Go To 2  No → Go To 3	All
2	Refer to the Service Information and perform the Glow Plug Test. Are all Glow Plugs operating properly?  Yes → Test Complete.  No → Replace the Glow Plug(s) as necessary. Perform ROAD TEST VERIFICATION - VER-2.	All
3	<b>NOTE: If the Glow Plug Relay fuse or fuselink is open, refer to the system schematics for all circuits that are powered by the Glow Plug Relay fuse or fuselink to determine the cause of the blown fuse/fuselink.</b> Remove the Glow Plug Relay of the affected cylinder(s). Using a 12-volt test light connected to ground, probe the Fused B+ circuit in the Glow Plug Relay connector. Does the test light illuminate brightly?  Yes → Go To 4  No → Repair the Fused B+ (Fuse/Fuselink) circuit for an open. Perform ROAD TEST VERIFICATION - VER-2.	All

**\*CHECKING THE GLOW PLUG OPERATION — Continued**

TEST	ACTION	APPLICABILITY
4	Turn the ignition off. Disconnect the Glow Plug harness connectors of the affected cylinder(s). Remove the Glow Plug Relay of the affected cylinder(s). Turn the ignition on. Measure the voltage on the Glow Plug Relay Output circuit of the affected cylinder(s). Is the voltage above 1.0 volt?  Yes → Repair the Glow Plug Relay Output circuit for a short to voltage. Perform ROAD TEST VERIFICATION - VER-2.  No → Go To 5	All
5	Turn the ignition off. Disconnect the Glow Plug harness connectors of the affected cylinder(s). Remove the Glow Plug Relay of the affected cylinder(s). Measure the resistance between ground and the Glow Plug Relay Output circuit of the affected cylinder(s). Is the resistance above 100 kohms?  Yes → Go To 6  No → Repair the Glow Plug Relay Output circuit for a short to ground. Inspect the fuse or fuselink and replace as necessary. Perform ROAD TEST VERIFICATION - VER-2.	All
6	Turn the ignition off. Disconnect the Glow Plug harness connectors of the affected cylinder(s). Remove the Glow Plug Relay of the affected cylinder(s). Connect a jumper wire across Glow Plug Relay connector cavities 30 and 87. Using a 12-volt test light connected to ground, check the Glow Plug Relay Output circuit at the Glow Plug harness connectors of the affected cylinder(s). Is the test light on at each Glow Plug harness connector?  Yes → Go To 7  No → Repair the Glow Plug Relay Output circuit for an open. Perform ROAD TEST VERIFICATION - VER-2.	All
7	If there are no possible causes remaining, view repair.  Repair Replace the Glow Plug Relay of the affected cylinder(s). Perform ROAD TEST VERIFICATION - VER-2.	All

**Symptom:**

**\*CHECKING THE PARK NEUTRAL SWITCH SIGNAL**

POSSIBLE CAUSES
CHECK FOR TRANSMISSION CONTROL MODULE DTCS
ENGINE CONTROL MODULE
P/N SENSE CIRCUIT SHORTED TO VOLTAGE
P/N SWITCH SENSE CIRCUIT OPEN
P/N SWITCH SENSE CIRCUIT SHORTED TO GROUND

TEST	ACTION	APPLICABILITY
1	Turn the ignition on. With the DRBIII®, read Transmission DTCS. Are any TCM DTCS present?  Yes → Refer to the Transmission Diagnostics Information for related symptom(s). Perform ROAD TEST VERIFICATION - VER-2.  No → Go To 2	All
2	Turn the ignition off. Disconnect the TCM harness connector. Turn the ignition on. With the DRBIII® in Engine Inputs/Outputs, read the P/N Switch state. Connect one end of a fused jumper wire to the P/N Switch Sense circuit at the TCM harness connector. Connect the other end of the jumper to ground for 10 seconds then disconnect from ground. Does the DRB Switch state change when connecting and disconnecting from ground?  Yes → Test Complete.  No → Go To 3	All
3	Turn the ignition off. Disconnect the TCM harness connector. Disconnect the ECM harness connectors. Remove the ASD Relay from the PDC. Connect a jumper wire between cavities 30 and 87 in the ASD connector in the PDC. Turn the ignition on. Measure the voltage of the P/N Switch Sense circuit. Is the voltage above 1.0 volt?  Yes → Repair the Park/Neutral Switch Sense circuit for a short to voltage. Perform ROAD TEST VERIFICATION - VER-2.  No → Go To 4	All



**\*CHECKING THE PARK NEUTRAL SWITCH SIGNAL — Continued**

TEST	ACTION	APPLICABILITY
4	Turn the ignition off. Disconnect the TCM harness connector. Disconnect the ECM harness connectors. Measure the resistance of the P/N Switch Sense circuit. Is the resistance below 10.0 ohms?  Yes → Go To 5  No → Repair the Park/Neutral Position Sense circuit for an open. Perform ROAD TEST VERIFICATION - VER-2.	All
5	Turn the ignition off. Disconnect the TCM harness connector. Disconnect the ECM harness connectors. Measure the resistance between ground and the P/N Switch Sense circuit. Is the resistance above 1000.0 ohms?  Yes → Replace and program the Engine Control Module in accordance with the Service Information. Perform ROAD TEST VERIFICATION - VER-2.  No → Repair the P/N Switch Sense circuit for a short to ground. Perform ROAD TEST VERIFICATION - VER-2.	All

**Symptom:**

**\*CHECKING THE SPEED CONTROL OPERATION**

POSSIBLE CAUSES
BRAKE SWITCH SIGNAL
ECM DTC(S) PRESENT
ENGINE CONTROL MODULE
SPEED CONTROL SWITCHES
VSS SIGNAL
INTERMITTENT CONDITION

TEST	ACTION	APPLICABILITY
1	Turn the ignition on. With the DRBIII®, read the ECM DTCs. Are there any ECM DTCs present?  Yes → Refer to symptom list for problems related to the ECM DTC. Perform SPEED CONTROL VERIFICATION - VER-4.  No → Go To 2	All
2	Start the engine. With the DRBIII®, read the S/C SWITCH VOLTS. Observe the S/C Switch volts on the DRBIII® while pressing and holding each S/C Switch button separately. <b>NOTE: Pressing each S/C Switch button should result in the following voltages: ON/OFF 0.55v - 1.15, SET 3.0 - 3.6v, RESUME/ACCEL 3.9 - 4.2v, CANCEL 1.2 - 2.05v, COAST 2.2 - 2.95v, No Button Pressed 4.4 - 4.7v</b> Does each switch provide the correct voltage?  Yes → Go To 3  No → Refer to symptom list for problems related to S/C Switches. Perform SPEED CONTROL VERIFICATION - VER-4.	All
3	Test drive the vehicle above 60 km/h (35 MPH). Attempt to Set the Speed Control. Does the Speed Control function properly?  Yes → Test Complete.  No → Go To 4	All
4	Turn the ignition on. With the DRBIII® in Sensors, read Vehicle Speed. Have an assistant drive the vehicle while you are observing the Vehicle Speed on the DRBIII®. While observing vehicle speed on the DRBIII®, note any rapid changes (signal dropouts) in the reading that do not correspond with actual vehicle speed. Is the DRBIII® displaying an accurate vehicle speed?  Yes → Go To 5  No → Refer to symptom list for problems related to the Vehicle Speed Sensor. Perform SPEED CONTROL VERIFICATION - VER-4.	All

**\*CHECKING THE SPEED CONTROL OPERATION — Continued**

TEST	ACTION	APPLICABILITY
5	<p>Turn the ignition on.</p> <p>With the DRBIII® in Inputs/Outputs, read the Primary and Secondary brake switch states while pressing and releasing the Brake Pedal several times.</p> <p>Did the DRBIII® indicate the correct brake pedal state when pressing and releasing the Brake Pedal?</p> <p>Yes → Go To 6</p> <p>No → Refer to symptom list for problems related to Brake Switch Signal.</p> <p>Perform SPEED CONTROL VERIFICATION - VER-4.</p>	All
6	<p><b>WARNING: WHEN THE ENGINE IS OPERATING, DO NOT STAND IN A DIRECT LINE WITH THE FAN. DO NOT PUT YOUR HANDS NEAR THE PULLEYS, BELTS OR FAN. DO NOT WEAR LOOSE CLOTHING.</b></p> <p>Refer to any Technical Service Bulletins (TSB) that may apply.</p> <p>Visually inspect the related wiring harness. Look for any chafed, pierced, pinched, or partially broken wires.</p> <p>Visually inspect the related wiring harness connectors. Look for broken, bent, pushed out, or corroded terminals.</p> <p>Were any of the above conditions present?</p> <p>Yes → Repair as necessary.</p> <p>Perform SPEED CONTROL VERIFICATION - VER-4.</p> <p>No → Replace and program the Engine Control Module in accordance with the Service Information.</p> <p>Perform SPEED CONTROL VERIFICATION - VER-4.</p>	All

**Symptom:**

**\*CHECKING THE TRANSFER CASE POSITION SENSOR**

**POSSIBLE CAUSES**

CHECKING THE TRANSFER CASE POSITION SENSOR

TEST	ACTION	APPLICABILITY
1	<p>Turn the ignition on.                      With the DRBIII® read the T-case Sensor                      Observe the T-case volts on the DRB while moving the transfer case selector lever in each of the transfer case positions.  <b>NOTE: When shifting the transfer case selector to each position, the Sensor voltage should result in the following voltages: 4WD Full Time 1.24 - 1.55, 4WD Low 0.16 - 0.40, Neutral 0.68 - 0.97.</b>                      Does each position provide the correct voltage?</p> <p>Yes → Test Complete.</p> <p>No → Using the wiring diagram/schematic as a guide, inspect the wiring and connectors between the Transfer Case Position Sensor and the ECM. If wiring and connectors are ok, replace the Transfer Case Position Sensor.                      Perform ROAD TEST VERIFICATION - VER-2.</p>	All

**Symptom:**

**\*CHECKING THE VISCOUS/CABIN HEATER RELAY**

POSSIBLE CAUSES
FUSED B+ CIRCUIT OPEN VISCOUS HEATER RELAY OUTPUT CIRCUIT SHORTED TO VOLTAGE VISCOUS HEATER RELAY OUTPUT CIRCUIT SHORTED TO GROUND VISCOUS HEATER RELAY OUTPUT CIRCUIT OPEN VISCOUS HEATER RELAY

TEST	ACTION	APPLICABILITY
1	Turn the ignition on. With the DRB, actuate the Viscous Heater Relay. Is the clicking during the actuator test?  Yes → Test Complete.  No → Go To 2	All
2	<b>NOTE: If the Viscous Heater Relay fuse or fuselink is open, refer to the system schematics for all circuits that are powered by the Cabin Heater Relay fuse or fuselink to determine the cause of the blown fuse/fuselink.</b> Remove the Viscous Heater Relay. Using a 12-volt test light connected to ground, probe the Fused B+ circuit in the Viscous Heater Relay connector. Does the test light illuminate brightly?  Yes → Go To 3  No → Repair the Fused B+ (Fuse/Fuselink) circuit for an open. Perform ROAD TEST VERIFICATION - VER-2.	All
3	Turn the ignition off. Disconnect the Viscous Heater harness connector. Remove the Viscous Heater Relay. Turn the ignition on. Measure the voltage on the Viscous Heater Relay Output circuit. Is the voltage above 1.0 volt?  Yes → Repair the Viscous Heater Relay Output circuit for a short to voltage. Perform ROAD TEST VERIFICATION - VER-2.  No → Go To 4	All
4	Turn the ignition off. Disconnect the Viscous Heater harness connector. Remove the Viscous Heater Relay. Measure the resistance between ground and the Viscous Heater Relay Output circuit. Is the resistance above 1000 ohms?  Yes → Go To 5  No → Repair the Viscous Heater Relay Output circuit for a short to ground. Inspect the fuse or fuselink and replace as necessary. Perform ROAD TEST VERIFICATION - VER-2.	All

**\*CHECKING THE VISCOUS/CABIN HEATER RELAY — Continued**

TEST	ACTION	APPLICABILITY
5	Turn the ignition off. Disconnect the Viscous Heater harness connector. Remove the Viscous Heater Relay. Connect a jumper wire across Viscous Heater Relay connector cavities 30 and 87. Using a 12-volt test light connected to ground, check the Viscous Heater Relay Output circuit in the Viscous Heater harness connector. Does the test light illuminate brightly?  Yes → Go To 6  No → Repair the Viscous Heater Relay Output circuit for an open. Perform ROAD TEST VERIFICATION - VER-2.	All
6	If there are no possible causes remaining, view repair.  Repair Replace the Viscous Heater Relay. Perform ROAD TEST VERIFICATION - VER-2.	All

**Symptom:**

**\*CHECKING THE WATER IN FUEL LAMP OPERATION**

POSSIBLE CAUSES
ASD RELAY OUTPUT CIRCUIT OPEN
ECM
SENSOR GROUND CIRCUIT OPEN
VERIFY WIF INDICATOR OPERATION
WATER IN FUEL SENOR SIGNAL CIRCUIT OPEN
WATER IN FUEL SENOR SIGNAL CIRCUIT SHORTED TO GROUND
WATER IN FUEL SENOR SIGNAL CIRCUIT SHORTED TO SENSOR GROUND
WATER IN FUEL SENSOR

TEST	ACTION	APPLICABILITY
1	Perform the Instrument Cluster Self-Test to verify proper WIF Indicator operation. Did the WIF Indicator operate correctly during Self-Test?  Yes → Go To 2  No → Test Complete.	All
2	Turn the ignition off. Disconnect the WIF Sensor harness connector. Turn the ignition on. Using a 12-volt test light connected to ground, check the ASD Relay Output circuit at the WIF Sensor harness connector. Does the test light illuminate brightly?  Yes → Go To 3  No → Repair the ASD Relay Output circuit for an open. Perform ROAD TEST VERIFICATION - VER-2.	All
3	Turn the ignition off. Disconnect the Water In Fuel Sensor harness connector. Turn the ignition on. With the DRB, read the Water In Fuel Switch state. Connect a jumper wire across the Water In Fuel Sensor harness connector cavities 1 and 2 for 10 seconds then disconnect the jumper. <b>NOTE: The DRB display should read CLOSED with the jumper connected and OPEN when the jumper is not connected.</b> Does the DRB Display switch between OPEN and CLOSED as described?  Yes → The WIF Sensor circuitry and the ECM are functioning properly. If there is still a WIF indicator problem replace the Water In Fuel Sensor. Perform ROAD TEST VERIFICATION - VER-2.  No → Go To 4	All

**\*CHECKING THE WATER IN FUEL LAMP OPERATION — Continued**

TEST	ACTION	APPLICABILITY
4	Turn the ignition off. Disconnect the Water In Fuel Sensor harness connector. Disconnect the ECM harness connectors. Measure the resistance of the Water In Fuel Sensor Signal circuit. Is the resistance below 5.0 ohms?  Yes → Go To 5  No → Repair the Water In Fuel Sensor Signal circuit for an open. Perform ROAD TEST VERIFICATION - VER-2.	All
5	Turn the ignition off. Disconnect the Water In Fuel Sensor harness connector. Disconnect the ECM harness connectors. Measure the resistance of the Sensor Ground circuit. Is the resistance below 5.0 ohms?  Yes → Go To 6  No → Repair the Sensor Ground circuit for an open. Perform ROAD TEST VERIFICATION - VER-2.	All
6	Turn the ignition off. Disconnect the Water In Fuel Sensor harness connector. Disconnect the ECM harness connectors. Measure the resistance between ground and the Water In Fuel Sensor Signal circuit. Is the resistance below 1000.0 ohms?  Yes → Go To 7  No → Repair the Water In Fuel Sensor Signal circuit for a short to ground. Perform ROAD TEST VERIFICATION - VER-2.	All
7	Turn the ignition off. Disconnect the Water In Fuel Sensor harness connector. Disconnect the ECM harness connectors. Measure the resistance between Sensor Ground and the Water In Fuel Sensor Signal circuit at the WIF Sensor harness connector. Is the resistance below 1000.0 ohms?  Yes → Repair the Water In Fuel Sensor Signal circuit for a short to Sensor Ground. Perform ROAD TEST VERIFICATION - VER-2.  No → Test Complete.	All



**Symptom:**

**\*ENGINE CRANKS BUT WILL NOT START**

POSSIBLE CAUSES
CHECK CAMSHAFT POSITION SENSOR SIGNAL
CHECK CRANKSHAFT POSITION SENSOR SIGNAL
CHECKING FOR ECM CODES
CHECKING FOR SKIM CODES
CHECKING THE ECT SENSOR
CHECKING THE GLOW PLUG OPERATION
ENGINE CONTROL MODULE
ENGINE DRIVE GEAR/SPROCKET
FUEL INJECTOR DRIVER CIRCUIT(S) SHORTED TO GROUND
FUEL PRESSURE SENSOR
FUEL PRESSURE SENSOR 5-VOLT SUPPLY CIRCUIT OPEN
FUEL PRESSURE SENSOR SIGNAL CIRCUIT OPEN
FUEL SUPPLY CONTAMINATION
FUEL SYSTEM PRESSURE MECHANICAL
FUEL SYSTEM RESTRICTION
SENSOR GROUND OPEN

TEST	ACTION	APPLICABILITY
1	<p><b>NOTE: The ECM must have proper power and ground connections for the following tests to be valid. Refer to Checking the ECM Power and Grounds in the symptom list.</b></p> <p>Turn the ignition on.                      With the DRBIII®, read the ECM DTCs.                      Does the DRBIII® display any ECM DTCs?</p> <p style="padding-left: 40px;">Yes → Refer to symptom list for problems related to ECM DTC.                      Perform NO START VERIFICATION - VER-1.</p> <p style="padding-left: 40px;">No → Go To 2</p>	All
2	<p>Turn the ignition on.                      With the DRBIII®, read the SKIM DTCs.                      Does the DRBIII® display any SKIM DTCs?</p> <p style="padding-left: 40px;">Yes → Refer to symptom list for problems related to SKIM DTC.                      Perform NO START VERIFICATION - VER-1.</p> <p style="padding-left: 40px;">No → Go To 3</p>	All

**\*ENGINE CRANKS BUT WILL NOT START — Continued**

TEST	ACTION	APPLICABILITY
3	<p>Using a temperature probe, check the vehicle temperature near the ECT Sensor. Turn the ignition on. With the DRBIII® in Sensors, read the ECT Sensor temperature. Compare the temperature probe reading with the DRBIII® reading. Are the two readings within 10°C of each other?</p> <p>Yes → Go To 4</p> <p>No → Repair as necessary. Perform NO START VERIFICATION - VER-1.</p>	All
4	<p><b>NOTE: Prior to performing this test, be sure to check the Glow Plug Relay operation. Refer to CHECKING GLOW PLUG OPERATION for the related symptom(s).</b> Refer to the Service Information and check the Glow Plugs for proper operation. Are the Glow Plugs operating properly?</p> <p>Yes → Go To 5</p> <p>No → Repair as necessary. Perform NO START VERIFICATION - VER-1.</p>	All
5	<p>Turn the ignition off. Disconnect the ECM harness connectors. Disconnect all 5 Fuel Injector harness connectors. Measure the resistance between Ground and each Fuel Injector Driver circuit at it's respective Fuel Injector harness connector. Is the resistance below 1000 ohms for any of the measurements?</p> <p>Yes → Repair the Fuel Injector Driver circuit(s) for a short to ground. Perform NO START VERIFICATION - VER-1.</p> <p>No → Go To 6</p>	All
6	<p>Inspect the fuel system lines for restrictions, leaks or other problems. Is there any evidence of problems?</p> <p>Yes → Repair as necessary. Perform NO START VERIFICATION - VER-1.</p> <p>No → Go To 7</p>	All
7	<p>Turn the ignition off. Using the DRBIII® lab scope, backprobe the CMP Sensor Signal circuit at the ECM harness connector. Start the engine, if the engine will not start, crank the engine for several seconds while monitoring the DRBIII®. <b>NOTE: Refer to Charts and Graphs to view a correct CMP Sensor signal.</b> Does the DRBIII® display a steady clean CMP Signal pattern?</p> <p>Yes → Go To 8</p> <p>No → Perform Test for DTC P0340-Camshaft Position Sensor Circuit Static Plausibility. Perform NO START VERIFICATION - VER-1.</p>	All

## \*ENGINE CRANKS BUT WILL NOT START — Continued

TEST	ACTION	APPLICABILITY
8	<p>Turn the ignition off. Using the DRBIII® lab scope, backprobe both of the CKP Sensor Signal circuits at the ECM harness connector.</p> <p><b>NOTE: Refer to Charts and Graphs to view a correct CKP Sensor signal.</b> Start the engine, if the engine will not start, crank the engine for several seconds while monitoring the DRBIII®.</p> <p>Does the DRBIII® display a steady clean CKP Signal pattern for each circuit?</p> <p>Yes → Go To 9</p> <p>No → Perform Test for DTC P0340-Crankshaft Position Sensor Circuit Dynamic Plausibility. Perform NO START VERIFICATION - VER-1.</p>	All
9	<p>Refer to the Service Information and perform the fuel pressure test. Is the fuel pressure within specification?</p> <p>Yes → Go To 10</p> <p>No → Repair as necessary. Perform NO START VERIFICATION - VER-1.</p>	All
10	<p>Refer to the Service Information and perform the fuel pressure test. Note the test results. Using the DRBIII®, read the Fuel Pressure and compare the two readings. Are the two readings within 3450 kPa (500 PSI) of each other?</p> <p>Yes → Go To 11</p> <p>No → Go To 13</p>	All
11	<p>Refer to the Service Information to ensure the Engine Drive Gears/Sprocket are installed correctly and the camshaft and crankshaft gears are timed correctly. Were any problems found?</p> <p>Yes → Repair as necessary. Perform NO START VERIFICATION - VER-1.</p> <p>No → Go To 12</p>	All
12	<p>Inspect the fuel supply for contamination. Is the fuel contaminated?</p> <p>Yes → Check the fuel supply for contamination. Perform NO START VERIFICATION - VER-1.</p> <p>No → Replace and program the Engine Control Module in accordance with the Service Information. Perform NO START VERIFICATION - VER-1.</p>	All
13	<p>Turn the ignition off. Disconnect the Fuel Pressure Sensor harness connector. Disconnect the ECM harness connectors. Measure the resistance of the Fuel Pressure Sensor Signal circuit. Is the resistance below 10.0 ohms?</p> <p>Yes → Go To 14</p> <p>No → Repair the Fuel Pressure Sensor Signal circuit for an open. Perform NO START VERIFICATION - VER-1.</p>	All

**\*ENGINE CRANKS BUT WILL NOT START — Continued**

TEST	ACTION	APPLICABILITY
14	Turn the ignition off. Disconnect the Fuel Pressure Sensor harness connector. Disconnect the ECM harness connectors. Measure the resistance of the Fuel Pressure Sensor 5-volt Supply circuit. Is the resistance below 10.0 ohms?  Yes → Go To 15  No → Repair the Fuel Pressure Sensor 5-volt Supply circuit for an open. Perform NO START VERIFICATION - VER-1.	All
15	Turn the ignition off. Disconnect the Fuel Pressure Sensor harness connector. Disconnect the ECM harness connectors. Measure the resistance of the Sensor Ground circuit. Is the resistance below 10.0 ohms?  Yes → Replace the Fuel Pressure Sensor in accordance with the Service Information. Perform NO START VERIFICATION - VER-1.  No → Repair the Sensor Ground circuit for an open. Perform NO START VERIFICATION - VER-1.	All

## Symptom:

**\*ENGINE WILL NOT CRANK**

POSSIBLE CAUSES
BATTERY CABLE HIGH RESISTANCE
CHECKING FOR SKIM OR TCM CODES
ECM
INSPECT BATTERY CABLES
MECHANICAL PROBLEM
OPEN FUSED BATTERY (+) CIRCUIT
OPEN IGNITION SWITCH START CIRCUIT
OPEN IGNITION SWITCH START OUTPUT AT THE ECM
STARTER MOTOR
STARTER RELAY
STARTER RELAY CONTROL CIRCUIT OPEN
STARTER RELAY CONTROL CIRCUIT SHORTED TO VOLTAGE
STARTER RELAY OUTPUT CIRCUIT OPEN
VERIFY PARK/NEUTRAL SIGNAL

TEST	ACTION	APPLICABILITY
1	Turn the ignition off. <b>NOTE: The battery must be fully charged before diagnosing a no crank condition.</b> Inspect the battery cables for corrosion, looseness or other problems. Is there evidence of problems?  Yes → Repair as necessary. Perform NO START VERIFICATION - VER-1.  No → Go To 2	All
2	Turn the ignition on. With the DRBIII®, read the SKIM and TCM DTCs. Does the DRBIII® display any SKIM or TCM DTCs?  Yes → Refer to symptom list for problems related to SKIM or TCM. Perform NO START VERIFICATION - VER-1.  No → Go To 3	All
3	Turn the ignition on. With the DRBIII® in Engine, Inputs/Outputs, read the P/N Switch state while moving the gear selector between Park and reverse. Does the P/N Switch state change when moving the gear selector?  Yes → Go To 4  No → Refer to symptom list for problems related to Park/Neutral Switch Signal. Perform NO START VERIFICATION - VER-1.	All

**\*ENGINE WILL NOT CRANK — Continued**

TEST	ACTION	APPLICABILITY
4	<p><b>WARNING: The transmission must be in Neutral and the parking break must be engaged for this test.</b></p> <p><b>WARNING: The engine may be cranked in this test. Keep away from moving engine parts.</b></p> <p>Turn the ignition off.  Remove the Starter Relay from the PDC.  Briefly connect a jumper wire between the Starter Relay Output circuit and the Fused B+ circuit at the starter relay connector in the PDC.  Did the engine crank?</p> <p>Yes → Go To 5  No → Go To 10</p>	All
5	<p>Turn the ignition off.  Remove the Starter Relay from the PDC.  Install a substitute relay in place of the Starter Relay.  Attempt to start the engine.  Does the engine crank?</p> <p>Yes → Replace the Starter Relay.  Perform NO START VERIFICATION - VER-1.</p> <p>No → Go To 6</p>	All
6	<p>Remove the Starter Relay from the PDC.  Using a 12-volt test light connected to ground, check the Ignition Switch Start circuit while turning the ignition switch to the START position.  Does the test light illuminate with the ignition switch in the START position?</p> <p>Yes → Go To 7  No → Repair the Ignition Switch Start circuit for an open.  Perform NO START VERIFICATION - VER-1.</p>	All
7	<p>Turn the ignition off.  Disconnect the ECM harness connectors.  Remove the Starter Relay from the PDC.  Remove the ASD Relay from the PDC.  Using a jumper wire, connect ASD Relay connector cavities 30 and 87 in the PDC.  Turn the ignition on.  Measure the voltage of the Starter Relay Control circuit.  Is the voltage above 1.0 volt?</p> <p>Yes → Repair the Starter Relay Control circuit for a short to voltage.  Perform NO START VERIFICATION - VER-1.</p> <p>No → Go To 8</p>	All
8	<p>Turn the ignition off.  Disconnect the ECM harness connectors.  Remove the Starter Relay from the PDC.  Measure the resistance of the Starter Relay Control circuit.  Is the resistance below 10.0 ohms?</p> <p>Yes → Go To 9  No → Repair the Starter Relay Control circuit for an open.  Perform NO START VERIFICATION - VER-1.</p>	All

## \*ENGINE WILL NOT CRANK — Continued

TEST	ACTION	APPLICABILITY
9	<p>Using a 12-volt test light connected to ground, check the Ignition Switch Start Output circuit at ECM C1 harness connector cavity 22 while turning the ignition switch to the START position.</p> <p>Does the test light illuminate with the ignition switch in the START position?</p> <p>Yes → Replace and program the Engine Control Module in accordance with the Service Information. Perform NO START VERIFICATION - VER-1.</p> <p>No → Repair the Ignition Switch Start Output circuit at the ECM harness connector for an open. Perform NO START VERIFICATION - VER-1.</p>	All
10	<p>Remove the Starter Relay from the PDC.</p> <p>Using a 12-volt test light connected to ground, check the Fused B+ circuit in the Starter Relay connector in the PDC.</p> <p>Is the test light on?</p> <p>Yes → Go To 11</p> <p>No → Repair the Fused B(+) circuit for an open. Perform NO START VERIFICATION - VER-1.</p>	All
11	<p>Turn the ignition off.</p> <p>Remove the Starter Relay from the PDC.</p> <p>Disconnect the Starter Relay Output wire from the Starter Solenoid.</p> <p>Connect the Starter Relay Output wire (at the Starter) to ground.</p> <p>Using a 12-volt test light connected to 12-volts, check the Starter Relay Output circuit at the Starter Relay connector in the PDC.</p> <p>Does the test light illuminate brightly?</p> <p>Yes → Go To 12</p> <p>No → Repair the Starter Relay Output circuit for an open. Perform NO START VERIFICATION - VER-1.</p>	All
12	<p>Using the Service Information, check the battery cables for high resistance.</p> <p>Did either battery cable have a voltage drop greater than 0.2 volts?</p> <p>Yes → Replace the battery cable(s). Perform NO START VERIFICATION - VER-1.</p> <p>No → Go To 13</p>	All
13	<p>Turn the ignition off.</p> <p>Attempt to manually rotate the crankshaft 360°.</p> <p>Is the crankshaft able to rotate 360°?</p> <p>Yes → Replace the Starter Motor. Perform NO START VERIFICATION - VER-1.</p> <p>No → Repair the engine mechanical problem. Perform NO START VERIFICATION - VER-1.</p>	All

**Symptom List:**

**ANTENNA FAILURE**  
**COP FAILURE**  
**EEPROM FAILURE**  
**INTERNAL FAULT**  
**RAM FAILURE**  
**SERIAL LINK INTERNAL FAULT**  
**STACK OVERFLOW FAILURE**

---

**Test Note: All symptoms listed above are diagnosed using the same tests.  
The title for the tests will be ANTENNA FAILURE.**

---

**When Monitored and Set Condition:**

**ANTENNA FAILURE**

When Monitored: Every 250 milliseconds with the ignition on.

Set Condition: The SKIM's microcontroller determines that an antenna circuit fault has occurred for 2.0 consecutive seconds.

**COP FAILURE**

When Monitored: With the ignition on.

Set Condition: The COP timer is not reset by the micro controller every 65.5 milliseconds.

**EEPROM FAILURE**

When Monitored: With the ignition on.

Set Condition: When the value written to EEPROM memory does not equal the value read back after the write operation.

**INTERNAL FAULT**

When Monitored: With the ignition on.

Set Condition: The SKIM has detected a fault during an internal self test.

**RAM FAILURE**

When Monitored: With the ignition on.

Set Condition: The RAM fails a test that checks the RAM's ability to retain memory.

**SERIAL LINK INTERNAL FAULT**

When Monitored: With the ignition on.

Set Condition: The SKIM fails an internal J1850 communication self test.

**STACK OVERFLOW FAILURE**

When Monitored: With the ignition on.

Set Condition: The micro controller has exceeded its stack space limit.



# SENTRY KEY IMMOBILIZER

---

## ANTENNA FAILURE — Continued

POSSIBLE CAUSES
SKIM INTERNAL DTC FAILURE

TEST	ACTION	APPLICABILITY
1	<p><b>Note: This trouble code indicates an internal SKIM fault.</b></p> <p>With the DRBIII®, read and record the SKIM DTCs and then erase the SKIM DTCs. Perform 10 ignition key cycles, leaving the ignition key on for a minimum of 90 seconds per cycle.</p> <p>With the DRBIII®, read the SKIM DTCs.</p> <p>Did the same SKIM DTC return?</p> <p>Yes → Replace and program the Sentry Key Immobilizer Module in accordance with the Service Information. Perform SKIS VERIFICATION.</p> <p>No → Test Complete.</p>	All

**Symptom List:**

**PCM STATUS FAILURE  
SERIAL LINK EXTERNAL FAULT**

**Test Note: All symptoms listed above are diagnosed using the same tests.  
The title for the tests will be PCM STATUS FAILURE.**

**When Monitored and Set Condition:**

**PCM STATUS FAILURE**

When Monitored: With the ignition on.

Set Condition: This DTC exists when a PCM STATUS message was not received from the PCM for at least 20.0 consecutive seconds.

**SERIAL LINK EXTERNAL FAULT**

When Monitored: At ignition on, after ignition on during any rolling code handshake that occurs with the ECM due to a SKIM reset, or during SECRET KEY transfers to the ECM.

Set Condition: When the SKIM does not receive an expected PCI BUS message transmission acknowledgement from the ECM after 3 transmit attempts.

**POSSIBLE CAUSES**

INTERMITTENT WIRING HARNESS PROBLEM  
WIRING HARNESS INSPECTION  
SKIM/ECM

TEST	ACTION	APPLICABILITY
1	<p><b>NOTE: Ensure the ECM has proper power and ground connections before continuing.</b> With the DRBIII®, read and record the SKIM DTCs then erase the SKIM DTCs. Turn the ignition off. Wait 2 minutes. Turn the ignition on. With the DRBIII®, read the SKIM DTCs. Does the DRBIII® display the DTC that was previously erased?</p> <p>Yes → Go To 2 No → Go To 4</p>	All

# SENTRY KEY IMMOBILIZER

## PCM STATUS FAILURE — Continued

TEST	ACTION	APPLICABILITY
2	Turn the ignition off. <b>NOTE: Visually inspect the related wiring harness and CCD/PCI Bus (whichever applicable) circuits. Look for any chafed, pierced, pinched, or partially broken wires.</b> <b>NOTE: Visually inspect the related wiring harness connectors. Look for broken, bent, pushed out, or corroded terminals.</b> <b>Note: Refer to any Technical Service Bulletins (TSB) that may apply.</b> Were any problems found?  Yes → Repair as necessary. Perform SKIS VERIFICATION.  No → Go To 3	All
3	<b>NOTE: Before proceeding it will be necessary to obtain the SKIM PIN.</b> Turn the ignition on. With the DRBIII®, display and erase all ECM and SKIM DTC's. Perform 5 ignition key cycles, leaving the ignition key on for a minimum of 90 seconds per cycle. With the DRBIII®, read the SKIM DTCs. Does the code appear?  Yes → Replace and program the Engine Control Module in accordance with the Service Information. Perform SKIS VERIFICATION.  No → Test Complete.	All
4	Turn the ignition off. <b>Note: Visually inspect the related wiring harness. Look for any chafed, pierced, pinched, or partially broken wires.</b> <b>NOTE: Visually inspect the related wiring harness connectors. Look for broken, bent, pushed out, or corroded terminals.</b> <b>Note: Refer to any Technical Service Bulletins (TSB) that may apply.</b> Were any problems found?  Yes → Repair wiring harness/connectors as necessary. Perform SKIS VERIFICATION.  No → Test Complete.	All

**Symptom List:**

**ROLLING CODE FAILURE  
VIN MISMATCH**

**Test Note: All symptoms listed above are diagnosed using the same tests.  
The title for the tests will be ROLLING CODE FAILURE.**

**When Monitored and Set Condition:**

**ROLLING CODE FAILURE**

When Monitored: At ignition on, after ignition on during any rolling code handshake that occurs with the ECM due to a SKIM or ECM reset.

Set Condition: When a PCM STATUS message with a Valid Key status is not received by the SKIM within 3.5 seconds of transmitting the last Valid Key Code message to the ECM.

**VIN MISMATCH**

When Monitored: With the ignition on.

Set Condition: When the VIN received from the ECM does not match the VIN stored in the SKIM's EEPROM.

**POSSIBLE CAUSES**

VERIFYING ECM VIN  
REPLACE SKIM AND CHECK DTC'S  
INTERMITTENT WIRING HARNESS PROBLEM  
ECM

TEST	ACTION	APPLICABILITY
1	With the DRBIII®, erase the SKIM DTCs. Turn the ignition off. Wait 10 seconds. Turn the ignition on and wait 2 minutes. With the DRBIII®, read the SKIM DTCs. Does the DRBIII® display the DTC that was previously erased?  Yes → Go To 2  No → Go To 4	All

# SENTRY KEY IMMOBILIZER

## ROLLING CODE FAILURE — Continued

TEST	ACTION	APPLICABILITY
2	<p>Turn the ignition on. With the DRBIII®, select Engine system from the main menu. Display and record the Vehicle Identification Number. <b>NOTE: Ensure that a VIN has been programmed into the ECM. If a VIN is not displayed, attempt to program the ECM with the correct vehicle VIN before continuing.</b> Does the VIN recorded from the ECM match the VIN of the vehicle?</p> <p>Yes → Go To 3</p> <p>No → Replace and program the Engine Control Module in accordance with the Service Information. Perform SKIS VERIFICATION.</p>	All
3	<p>Turn the ignition off. Replace and program the Sentry Key Immobilizer Module in accordance with the Service Information. Turn the ignition on. With the DRBIII®, display and clear all ECM and SKIM DTC's. Perform 5 ignition key cycles leaving the ignition key on for 90 seconds per cycle. With the DRBIII®, check for SKIM DTCs. Does the DRBIII® display the same DTC?</p> <p>Yes → Replace and program the Engine Control Module in accordance with the Service Information. Perform SKIS VERIFICATION.</p> <p>No → The repair is complete. Perform SKIS VERIFICATION.</p>	All
4	<p>Turn the ignition off. <b>Note: Visually inspect the related wiring harness. Look for any chafed, pierced, pinched, or partially broken wires.</b> <b>NOTE: Visually inspect the related wiring harness connectors. Look for broken, bent, pushed out, or corroded terminals.</b> <b>Note: Refer to any Technical Service Bulletins (TSB) that may apply.</b> Were any problems found?</p> <p>Yes → Repair wiring harness/connectors as necessary. Perform SKIS VERIFICATION.</p> <p>No → Test Complete.</p>	All

**Symptom List:**

**TRANSPONDER COMMUNICATION FAILURE**  
**TRANSPONDER CYCLIC REDUNDANCY CHECK (CRC) FAILURE**  
**TRANSPONDER ID MISMATCH**  
**TRANSPONDER RESPONSE MISMATCH**

**Test Note: All symptoms listed above are diagnosed using the same tests. The title for the tests will be TRANSPONDER COMMUNICATION FAILURE.**

**When Monitored and Set Condition:**

**TRANSPONDER COMMUNICATION FAILURE**

When Monitored: At ignition on and during Key Programming Mode.

Set Condition: When the SKIM does not receive a transponder response after 8 consecutive transponder read attempts within 2.0 seconds.

**TRANSPONDER CYCLIC REDUNDANCY CHECK (CRC) FAILURE**

When Monitored: At ignition on and during Key Programming Mode.

Set Condition: When 5 consecutive transponder signal transmissions are sent to the SKIM with the correct message format but with invalid data.

**TRANSPONDER ID MISMATCH**

When Monitored: At ignition on and during Key Programming Mode.

Set Condition: When the transponder ID read by the SKIM does not match any of the transponder ID's stored in the SKIM's memory.

**TRANSPONDER RESPONSE MISMATCH**

When Monitored: At ignition on and during Key Programming Mode.

Set Condition: When the transponder's crypto algorithm result fails to match the SKIM's result.

**POSSIBLE CAUSES**

CHECKING MULTIPLE KEY OPERATION

SKIM

INTERMITTENT WIRING HARNESS PROBLEM

REPLACE IGNITION KEY

# SENTRY KEY IMMOBILIZER

## TRANSPONDER COMMUNICATION FAILURE — Continued

TEST	ACTION	APPLICABILITY
1	<p>With the DRBIII®, read and record the SKIM DTCs.            With the DRBIII®, erase the SKIM DTCs.  <b>NOTE: Perform the following test several times to ensure the DTC is current.</b>            Turn the ignition off.            Wait 10 seconds.            Turn the ignition on.            With the DRBIII®, read the SKIM DTCs.            Does the DRBIII® display the DTC that was previously erased?</p> <p>Yes → Go To 2            No → Go To 7</p>	All
2	<p>Are there multiple vehicle ignition keys available?</p> <p>Yes → Go To 3            No → Go To 4</p>	All
3	<p><b>NOTE: Perform the following steps using one of the vehicle ignition keys. When finished, repeat the procedure using each of the other vehicle keys one at a time.</b>            With the DRBIII®, erase the SKIM DTCs.            Turn the ignition off.            Wait 10 seconds.            Turn the ignition on.            With the DRBIII®, read the SKIM DTCs.            Is the DTC present for all ignition keys?</p> <p>Yes → Replace and program the Sentry Key Immobilizer Module in accordance with the Service Information.            Perform SKIS VERIFICATION.</p> <p>No → Replace the ignition key(s) that cause the SKIM DTC.            Perform SKIS VERIFICATION.</p>	All
4	<p>With the DRBIII®, attempt to reprogram the ignition keys to the SKIM.            With the DRBIII®, erase the SKIM DTCs.            Wait 10 seconds.            Turn the ignition on.            With the DRBIII®, read the SKIM DTCs.            Does the DTC set again?</p> <p>Yes → Go To 5            No → Test Complete.</p>	All
5	<p>Replace the ignition key with a new key.            With the DRBIII®, program the new ignition key to the SKIM.            With the DRBIII®, erase the SKIM DTCs.            Turn the ignition off.            Wait 10 seconds.            Turn the ignition on.            With the DRBIII®, read the SKIM DTCs.            Does the DTC set again?</p> <p>Yes → Go To 6            No → Test Complete.</p>	All

**TRANSPONDER COMMUNICATION FAILURE — Continued**

TEST	ACTION	APPLICABILITY
6	<p>If there are no possible causes remaining, view repair.</p> <p>Repair</p> <p>Replace and program the Sentry Key Immobilizer Module in accordance with the Service Information.</p> <p>Perform SKIS VERIFICATION.</p>	All
7	<p>Turn the ignition off.</p> <p><b>Note: Visually inspect the related wiring harness. Look for any chafed, pierced, pinched, or partially broken wires.</b></p> <p><b>NOTE: Visually inspect the related wiring harness connectors. Look for broken, bent, pushed out, or corroded terminals.</b></p> <p><b>Note: Refer to any Technical Service Bulletins (TSB) that may apply.</b></p> <p>Were any problems found?</p> <p>Yes → Repair wiring harness/connectors as necessary. Perform SKIS VERIFICATION.</p> <p>No → Test Complete.</p>	All



# VERIFICATION TESTS

## Verification Tests

BODY VERIFICATION TEST - VER 1	APPLICABILITY
<p>1. Disconnect all jumper wires and reconnect all previously disconnected components and connectors.</p> <p>2. If the Sentry Key Immobilizer Module (SKIM) or the Engine Control Module (ECM) was replaced, proceed to number 5. If the SKIM or ECM was not replaced, continue to the next number.</p> <p>3. If the Body Control Module was replaced, turn the ignition on for 15 seconds (to learn VIN). If the vehicle is equipped with VTSS, use the DRB and enable VTSS.</p> <p>4. Program tire size, country code and all RKE transmitters (if RKE Module was replaced) and other options as necessary. Proceed to number 12.</p> <p>5. Obtain the Vehicle's unique PIN assigned to it's original SKIM from the vehicle's invoice.</p> <p>6. NOTE: Once Secured Access Mode is active, the SKIM will remain in that mode for 60 seconds.</p> <p>7. With the DRB, select THEFT ALARM, SKIM, MISCELLANEOUS and select SKIM REPLACED. Enter the 4 digit PIN to put the SKIM in Secured Access Mode.</p> <p>8. The DRB will prompt for the following steps.</p> <p>9. Using the DRB, program all customer keys into the SKIM memory. This requires that the SKIM be in Secured Access Mode, using the 4 digit PIN.</p> <p>10. Note: If the ECM is replaced, the VIN and the unique Secret Key data must be transferred from the SKIM to the ECM. This procedure requires the SKIM to be placed in Secured Access Mode using the 4-digit PIN.</p> <p>11. Note: If 3 attempts are made to enter Secured Access Mode using an incorrect PIN, Secured Access Mode will be locked out for 1 hour which causes the DRB to display "Bus +\ - Signals Open". To exit this mode, turn ignition to Run for 1 hour.</p> <p>12. Ensure all accessories are turned off and the battery is fully charged.</p> <p>13. Turn the Ignition on and with the DRB, erase all Diagnostic Trouble Codes from ALL modules. Start the engine and allow it to run for 2 minutes and fully operate the system that was malfunctioning.</p> <p>14. Turn the ignition off and wait 5 seconds. Turn the ignition on and using the DRB, read DTCs from ALL modules.</p> <p>Are any DTCs present or is the original complaint still present?</p> <p>Yes → Repair is not complete, refer to the appropriate symptom.</p> <p>No → Repair is complete.</p>	<p>All</p>

CHARGING VERIFICATION - VER-3	APPLICABILITY
<p>1. Inspect the vehicle to ensure that all engine components are properly installed and connected. Reassemble and reconnect components as necessary.</p> <p>2. With the DRB, erase all diagnostic trouble codes (DTCs).</p> <p>3. Start the engine.</p> <p>4. Raise the engine speed to 2000 RPM for at least 30 seconds.</p> <p>5. Allow the engine to idle.</p> <p>6. Turn the ignition off for 20 seconds.</p> <p>7. Turn the ignition on.</p> <p>8. With the DRB, read ECM DTCs.</p> <p>9. If this DTC has set again, or another DTC has set, look for any Technical Service Bulletins (TSBs) that may relate to this condition. Return to the Symptom List if necessary.</p> <p>10. If the charging system is functioning correctly and there are no DTCs, the repair is now complete.</p> <p>Are any DTCs or symptoms remaining?</p> <p>Yes → Repair is not complete, refer to appropriate symptom.</p> <p>No → Repair is complete.</p>	<p>All</p>

**Verification Tests — Continued**

<b>NO START VERIFICATION - VER-1</b>	<b>APPLICABILITY</b>
<p><b>1. NOTE: IMPORTANT! If the Engine Control Module or Sentry Key Immobilizer Module has been replaced, ensure the programming procedure for the module has been performed in accordance with the Service Information.</b></p> <p>2. Inspect the vehicle to ensure that all engine components are properly installed and connected. Reassemble and reconnect components as necessary.</p> <p>3. Inspect the engine oil for contamination. If it is contaminated, change the oil and filter.</p> <p>4. With the DRB, erase all diagnostic trouble codes (DTCs).</p> <p>5. Turn the ignition off for at least 10 seconds.</p> <p>6. Attempt to start the engine.</p> <p>7. If the engine is unable to start, look for any Technical Service Bulletins (TSBs) that may relate to this condition. Return to the Symptom List if necessary.</p> <p>8. If the engine starts and continues to run, the repair is now complete.</p> <p>Are any DTCs or symptoms remaining?</p> <p>Yes → Repair is not complete, refer to appropriate symptom.</p> <p>No → Repair is complete.</p>	<p>All</p>

<b>ROAD TEST VERIFICATION - VER-2</b>	<b>APPLICABILITY</b>
<p>1. Inspect the vehicle to ensure that all engine components are properly installed and connected. Reassemble and reconnect components as necessary.</p> <p>2. If this verification procedure is being performed after a non-DTC test, perform steps 3 and 4.</p> <p>3. Check to see if the initial symptom still exists. If there are no trouble codes and the symptom no longer exists, the repair was successful and testing is now complete.</p> <p>4. If the initial or another symptom exists, the repair is not complete. Check all pertinent Technical Service Bulletins (TSBs) and return to the Symptom List if necessary.</p> <p>5. For previously read DTCs that have not been dealt with, return to the Symptom List and follow the diagnostic path for that DTC; otherwise, continue.</p> <p>6. If the Engine Control Module (ECM) has not been changed, perform steps 7 and 8, otherwise, continue with step 9.</p> <p>7. With the DRB, erase all diagnostic trouble codes (DTCs), then disconnect the DRB.</p> <p>8. Turn the ignition off for at least 10 seconds.</p> <p>9. If equipped with a Transfer Case Position Switch, perform step 10, otherwise, continue with step 11.</p> <p>10. With the ignition switch on, place the Transfer Case Shift Lever in each gear position, stopping for 15 seconds in each position.</p> <p>11. Ensure no DTCs remain by performing steps 12 through 15.</p> <p>12. Road test the vehicle. For some of the road test, go at least 64 km/h (40 MPH). If this test is for an A/C Relay Control Circuit, drive the vehicle for at least 5 minutes with the A/C on.</p> <p>13. At some point, stop the vehicle and turn the engine off for at least 10 seconds, then restart the engine and continue.</p> <p>14. Upon completion of the road test, turn the engine off and check for DTCs with the DRB.</p> <p>15. If the repaired DTC has set again, the repair is not complete. Check for any pertinent Technical Service Bulletins (TSBs) and return to the Symptom List. If there are no DTCs, the repair was successful and is now complete.</p> <p>Are any DTCs or symptoms remaining?</p> <p>Yes → Repair is not complete, refer to appropriate symptom.</p> <p>No → Repair is complete.</p>	<p>All</p>

# VERIFICATION TESTS

## Verification Tests — Continued

SKIS VERIFICATION	APPLICABILITY
<p>1. Reconnect all previously disconnected components and connectors.</p> <p>2. Obtain the vehicle's unique Personal Identification Number (PIN) assigned to its original SKIM.</p> <p><b>3. NOTE: When entering the PIN, care should be taken because the SKIM will only allow 3 consecutive attempts to enter the correct PIN. If 3 consecutive incorrect PINs are entered, the SKIM will Lock Out the DRB for 1 hour.</b></p> <p>4. To exit Lock Out mode, the ignition key must remain in the Run position continually for 1 hour. Turn off all accessories and connect a battery charger if necessary.</p> <p>5. With the DRB, select Theft Alarm, SKIM and Miscellaneous. Then, select the desired procedure and follow the steps that will be displayed.</p> <p>6. If the SKIM has been replaced, ensure all of the vehicle ignition keys are programmed to the new SKIM.</p> <p><b>7. NOTE: Prior to returning vehicle to the customer, perform a module scan to be sure that all DTCs are erased. Erase any DTCs that are found.</b></p> <p>8. With the DRB, erase all DTCs. Perform 5 ignition key cycles leaving the key on for at least 90 seconds per cycle.</p> <p>9. With the DRB, read the SKIM DTCs.</p> <p>Are there any SKIM DTCs?</p> <p style="padding-left: 40px;">Yes → Repair is not complete, refer to appropriate symptom.</p> <p style="padding-left: 40px;">No → Repair is complete.</p>	<p>All</p>

SPEED CONTROL VERIFICATION - VER-4	APPLICABILITY
<p>1. Inspect the vehicle to ensure that all engine components are properly installed and connected. Reassemble and reconnect components as necessary.</p> <p>2. With the DRB, erase all diagnostic trouble codes (DTCs).</p> <p>3. Road test the vehicle at a speed above 58 km/h (35 MPH).</p> <p>4. Turn the speed control ON/OFF switch on.</p> <p>5. Depress and release the SET switch. If the speed control does not engage, the repair is not complete, continue with step 12.</p> <p>6. Quickly depress and release the RESUME/ACCEL switch. If the vehicle speed does not increase by 3 km/h (2 MPH), the repair is not complete, continue with step 12.</p> <p>7. Using caution, depress and release the brake pedal. If the speed control does not disengage, the repair is not complete, continue with step 12.</p> <p>8. With the vehicle speed at least 56 km/h (35 MPH), depress the RESUME/ACCEL switch. If the speed control does not resume at the previously set speed, the repair is not complete, continue with step 12.</p> <p>9. Hold down the COAST switch. If the vehicle does not decelerate, the repair is not complete, continue with step 12.</p> <p>10. While still holding down the COAST switch, ensure the vehicle speed is at least 56 km/h (35 MPH) and release the COAST switch. If the vehicle does not adjust and set a new vehicle speed, the repair is not complete, continue with step 12.</p> <p>11. With the speed control engaged, depress the ON/OFF switch. If the speed control does not disengage, the repair is not complete, continue with step 12.</p> <p>12. If the vehicle did not successfully perform all of the previous steps, check for Technical Service Bulletins (TSBs) that pertain to this speed control problem and then, if necessary, return to the Symptom List.</p> <p>13. If the vehicle successfully performed all of the previous steps, the speed control system is now functioning as designed. The repair is now complete.</p> <p>Are any DTCs or symptoms remaining?</p> <p style="padding-left: 40px;">Yes → Repair is not complete, refer to appropriate symptom.</p> <p style="padding-left: 40px;">No → Repair is complete.</p>	<p>All</p>

**Verification Tests — Continued**

<b>W5J400 TRANSMISSION VERIFICATION TEST - VER 1</b>	<b>APPLICABILITY</b>
<p><b>1. NOTE: If the TCM was replaced, use the DRBIII® to program the VIN information into the TCM</b></p> <p>2. Reconnect any disconnected components.</p> <p>3. Connect the DRBIII® to the Data Link Connector.</p> <p>4. With the DRBIII®, erase ABS DTC's.</p> <p>5. With the DRBIII®, erase PCM/ECM DTC's.</p> <p>6. With the DRBIII®, erase Transmission DTC's.</p> <p>7. With the DRBIII®, display Transmission Temperature. Start and run the engine until the Transmission Temperature is HOT, above 43° C (110° F).</p> <p>8. Check the Transmission fluid and adjust if necessary. Refer to the Service Information for the proper Fluid Fill procedure.</p> <p>9. Perform the ADAPTION PROCEDURE whenever the TCM and/or the Transmission has been replaced or major Transmission repairs have been performed. If none of these apply, proceed to ROAD TEST PROCEDURE.</p> <p>10. ADAPTION PROCEDURE</p> <p>11. With the DRBIII®, reset the Transmission adaptives. Resetting the adaptives will set the adaptives to factory settings.</p> <p>12. Drive the Vehicle until the Transmission Temperature is in the specified range.</p> <p><b>13. NOTE: Perform the Coast Down Adaptations first. The Transmission Temperature must be greater than 60° C (140° F) and less than 70° C (158° F). Failure to stay within these temperature ranges will void the procedure.</b></p> <p>14. Perform 4 to 5 Coast Downs from 5th to 4th gear and then 4th to 3rd gear.</p> <p><b>15. NOTE: For Upshift adaption, the Transmission temperature must be greater than 60° C (140° F) and less than 100° C (212° F). Failure to stay within these temperature ranges will void this procedure.</b></p> <p>16. From a stop, moderately accelerate the vehicle and obtain all forward gear ranges while keeping the Engine RPM below 1800 RPM. Repeat this procedure 4 to 5 times.</p> <p>17. Obtaining 5th gear may be difficult at 1800 RPM. Allow the transmission to shift into 5th gear at a higher RPM then lower the RPM to 1800 and perform manual shifts between 4th and 5th gears using the shift lever.</p> <p>18. The TCM will store the adaptives every 10 minutes. After completion of the Adaption Procedure make sure the vehicle stays running for at least 10 minutes. To manually store the adaptives under 10 minutes, use the DRBIII® Store Adaptives procedure.</p> <p>19. If the Shift Quality is not acceptable after performing the Adaption Procedure, repeat the Adaption Procedure.</p> <p><b>20. NOTE: If internal repairs were performed and the shift quality is still poor after repeating the Adaption Procedure, it may be necessary to check the internal repair. Also check for any TSBs and/or Controller Flash updates that may apply.</b></p> <p>21. ROAD TEST PROCEDURE</p> <p>22. Road test the vehicle. Make fifteen to twenty 1-2, 2-3, 3-4 and 4-5 upshifts.</p> <p>23. Perform these shifts from a standing start to 72 Km/h or 45 MPH with a constant throttle opening of 20 to 25 degrees.</p> <p>24. With speeds below 40 Km/h or 25 MPH, make five to eight wide open throttle kickdowns to 1st gear. Allow at least 5 seconds each in 2nd and 3rd gear between each kickdown.</p> <p>25. With the DRBIII®, perform the Transmission Solenoid Test.</p> <p>26. With the DRBIII®, read Transmission DTCs.</p> <p>Were there any Diagnostic Trouble Codes set?</p> <p style="padding-left: 40px;">Yes → Repair is not complete, refer to appropriate symptom.</p> <p style="padding-left: 40px;">No → Repair is complete.</p>	<p>All</p>



8.0 COMPONENT LOCATIONS

8.1 CONTROL MODULES

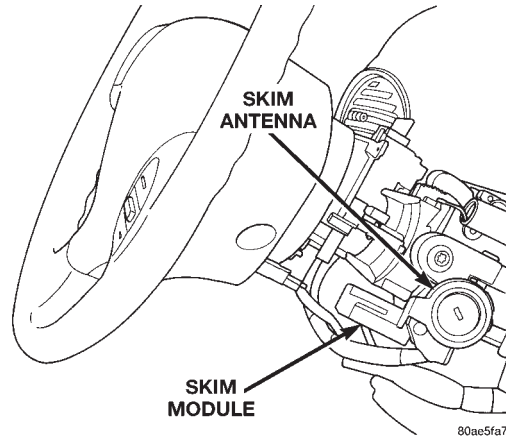
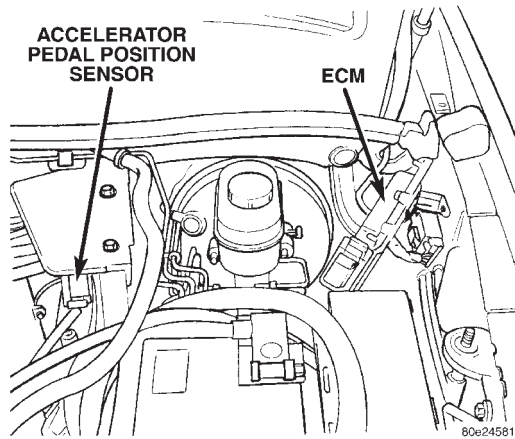

8.2 CONTROLS AND SOLENOIDS

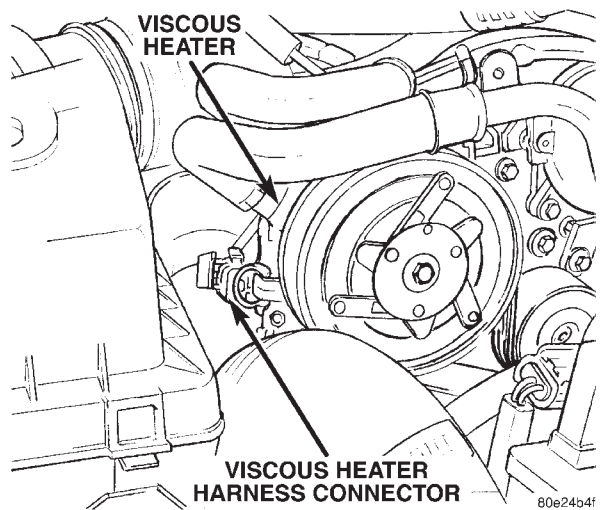
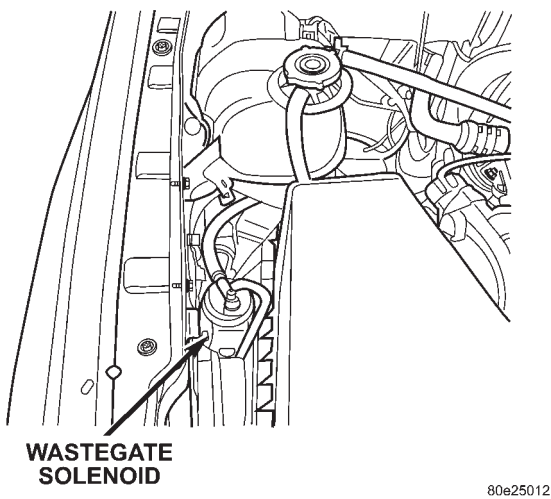
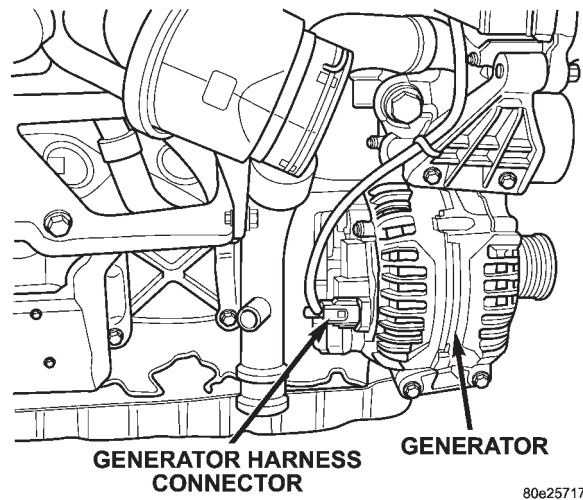
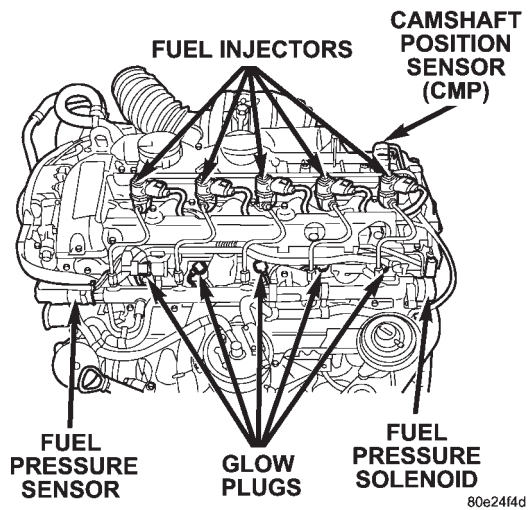



# COMPONENT LOCATIONS

## 8.3 DATA LINK CONNECTOR

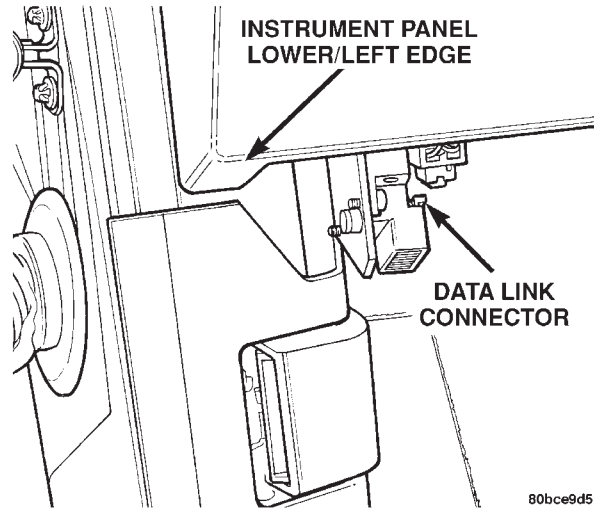

## 8.4 FUEL SYSTEM

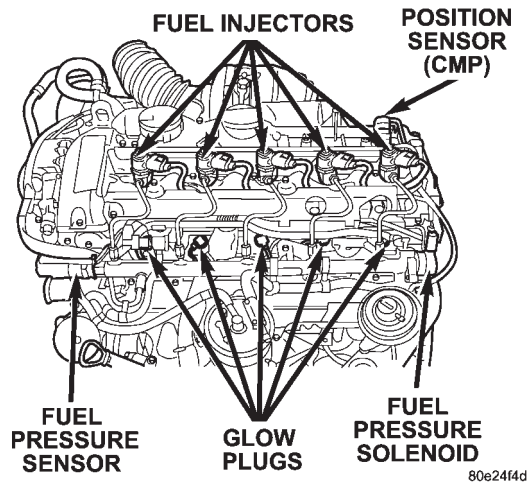

## 8.5 SENSORS

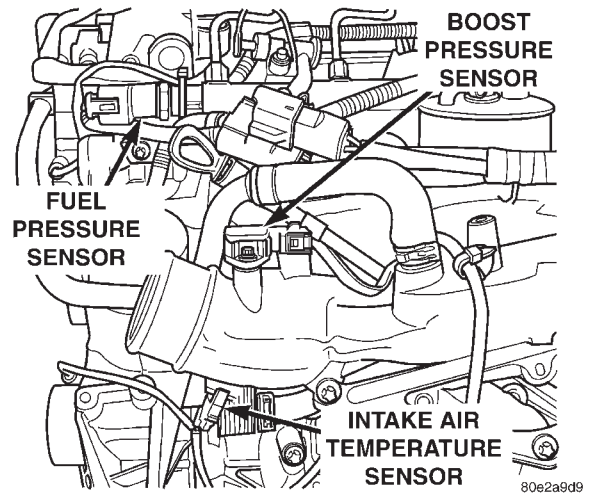
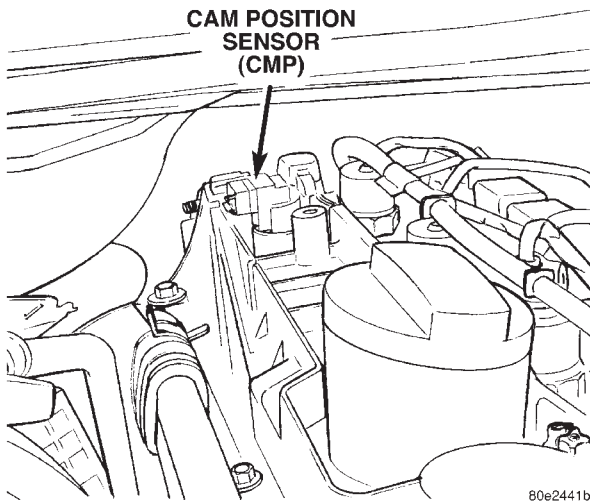

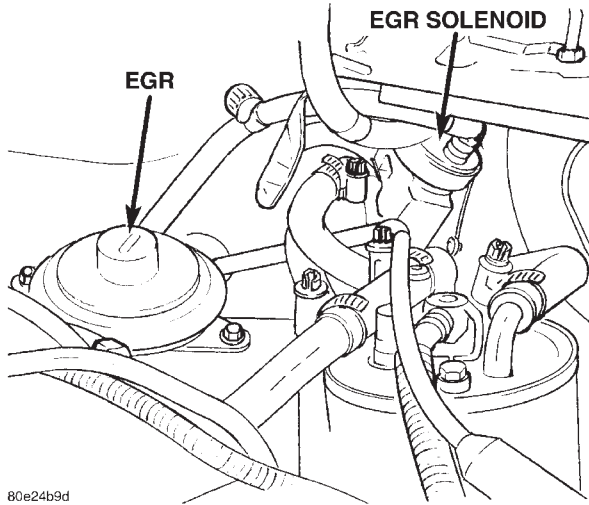

80e24b9d

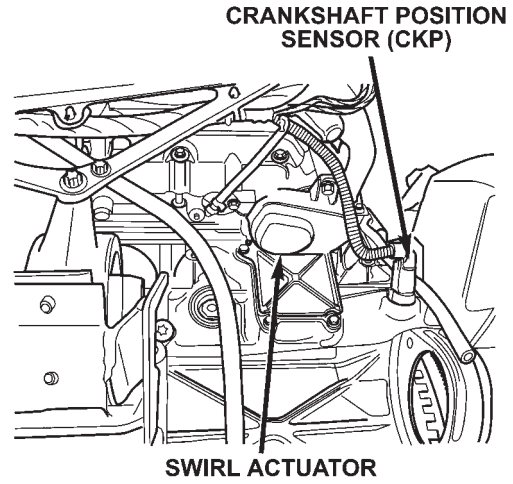

80e256ca

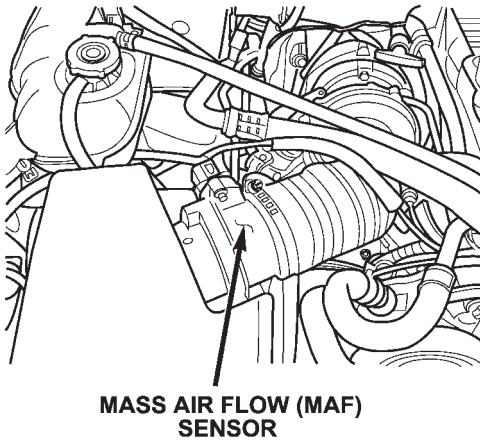

80e25031

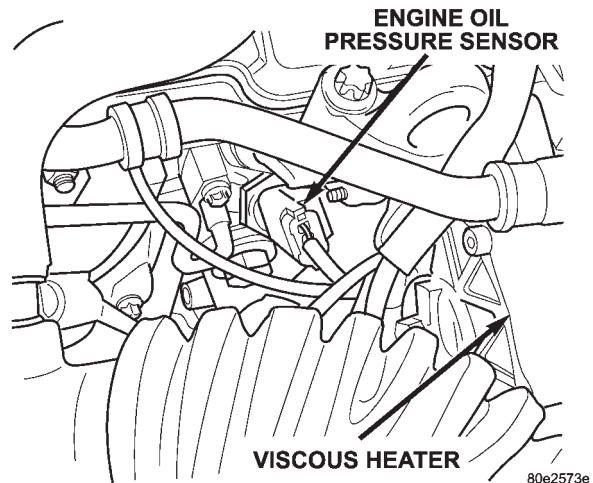

80e2573e

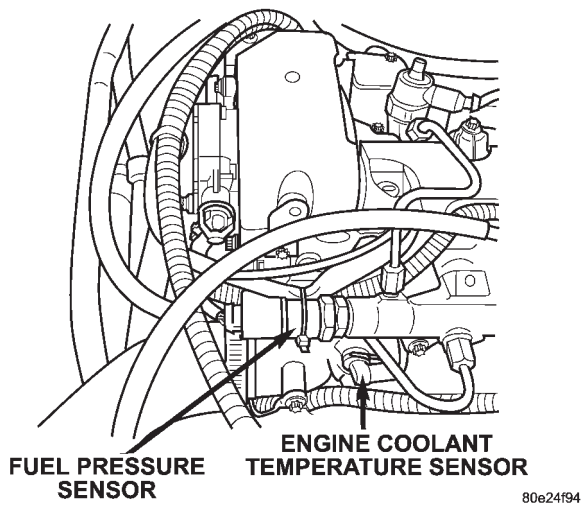

80e24f94

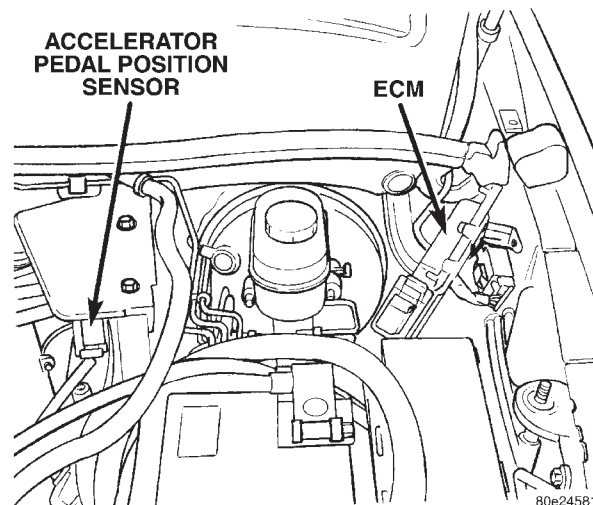

80e24581



# COMPONENT LOCATIONS

## 8.5 SENSORS (Continued)

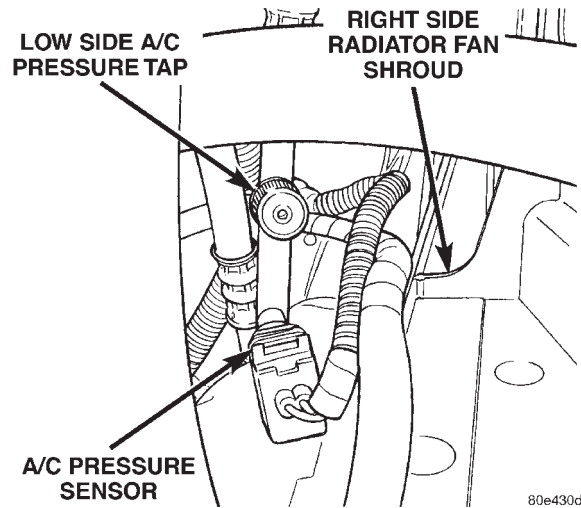
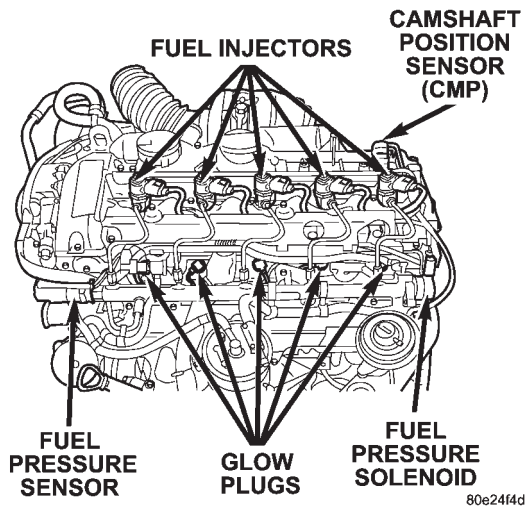

## 8.6 SWITCHES

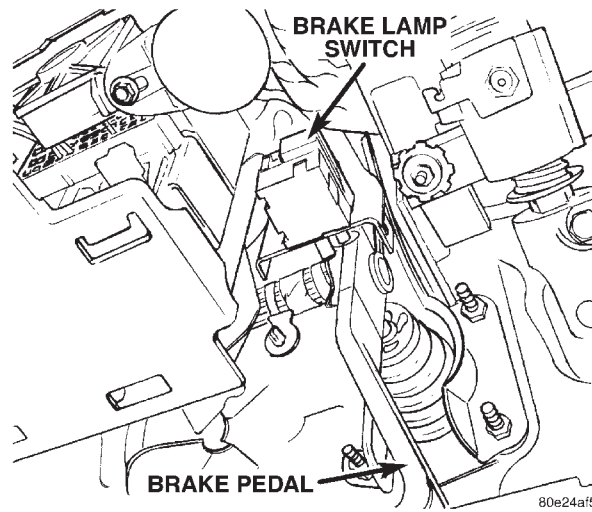

9.0 CONNECTOR PINOUTS

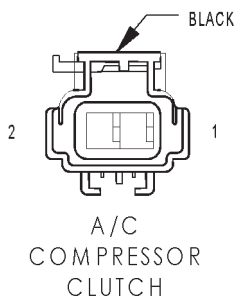

A/C COMPRESSOR CLUTCH - BLACK 2 WAY

CAV	CIRCUIT	FUNCTION
1	C2 18DB/YL	A/C COMPRESSOR CLUTCH RELAY OUTPUT
2	Z18 18BK	GROUND

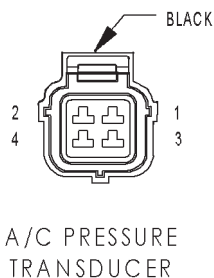

A/C PRESSURE TRANSDUCER - BLACK 4 WAY

CAV	CIRCUIT	FUNCTION
1	K4 18BK/LB	SENSOR GROUND
2	K6 18VT/WT (DIESEL)	SENSOR REFERENCE VOLTAGE B
2	K6 18VT/BK (GAS)	5 VOLT SUPPLY
3	C18 18DB	A/C PRESSURE SIGNAL
4	-	-

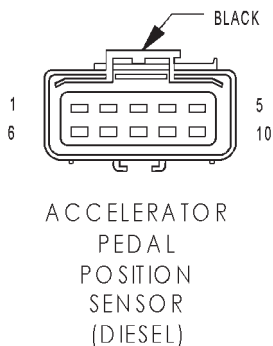

ACCELERATOR PEDAL POSITION SENSOR (DIESEL) - BLACK 10 WAY

CAV	CIRCUIT	FUNCTION
1	-	-
2	F855 18BR/YL	SENSOR REFERENCE VOLTAGE A
3	K22 14RD/DB	ACCELERATOR PEDAL POSITION SENSOR 2 SIGNAL
4	-	-
5	-	-
6	K225 18BK	ACCELERATOR PEDAL POSITION SENSOR 2 GROUND
7	K81 20DB/DG	ACCELERATOR PEDAL POSITION SENSOR 1 SIGNAL
8	K255 20WT/DG	ACCELERATOR PEDAL POSITION SENSOR 1 GROUND
9	-	-
10	Y43 20WT/VT	ACCELERATOR PEDAL POSITION SENSOR 1 5-VOLT SUPPLY

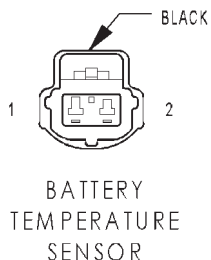

BATTERY TEMPERATURE SENSOR - BLACK 2 WAY

CAV	CIRCUIT	FUNCTION
1	K4 18BK/LB (GAS LHD)	SENSOR GROUND
1	K4 20BK/LB (DIESEL/RHD)	SENSOR GROUND
2	K25 18VT/LG	BATTERY TEMPERATURE SENSOR SIGNAL

# CONNECTOR PINOUTS

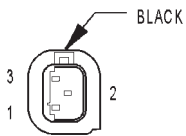

BOOST PRESSURE SENSOR (DIESEL)

**BOOST PRESSURE SENSOR (DIESEL) - BLACK 3 WAY**

CAV	CIRCUIT	FUNCTION
1	K4 20BK/LB	SENSOR GROUND
2	Y53 20VT/WT	BOOST PRESSURE SENSOR SIGNAL
3	K6 20BK/YL	SENSOR REFERENCE VOLTAGE B

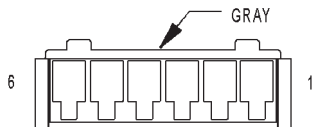

BRAKE LAMP SWITCH

**BRAKE LAMP SWITCH - GRAY 6 WAY**

CAV	CIRCUIT	FUNCTION
1	K29 18WT/PK	SECONDARY BRAKE SWITCH SIGNAL
2	Z238 18BK (LHD)	GROUND
2	Z243 18BK (RHD)	GROUND
3	V32 22OR/DG (GAS)	SPEED CONTROL POWER SUPPLY
4	V30 22DB/RD (GAS)	SPEED CONTROL BRAKE SWITCH OUTPUT
5	L50 20VT/TN (LHD)	PRIMARY BRAKE SWITCH SIGNAL
5	L50 20WT/TN (RHD)	PRIMARY BRAKE SWITCH SIGNAL
6	F32 20PK/DB	FUSED B(+)

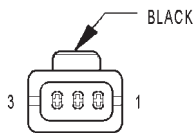

CAM SHAFT POSITION SENSOR (DIESEL)

**CAM SHAFT POSITION SENSOR (DIESEL) - BLACK 3 WAY**

CAV	CIRCUIT	FUNCTION
1	K944 20BR/DG	CAMSHAFT POSITION SENSOR GROUND
2	K44 20YL/GY	CAMSHAFT POSITION SENSOR SIGNAL
3	F15 18RD/DG	FUSED AUTO SHUT DOWN RELAY OUTPUT

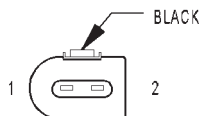

CRANKSHAFT POSITION SENSOR (DIESEL)

**CRANKSHAFT POSITION SENSOR (DIESEL) - BLACK 2 WAY**

CAV	CIRCUIT	FUNCTION
1	K924 20YL	CRANKSHAFT POSITION SENSOR SIGNAL 2
2	K3 20BK	CRANKSHAFT POSITION SENSOR SIGNAL 1

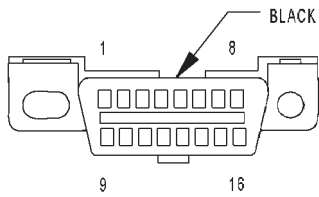

DATA LINK  
CONNECTOR

DATA LINK CONNECTOR - BLACK 16 WAY

CAV	CIRCUIT	FUNCTION
1	-	-
2	D25 20YL/VT	PCI BUS
3	-	-
4	Z305 20BK/OR	GROUND
5	Z306 20BK/LG	GROUND
6	D32 20LG/DG	SCI RECEIVE
7	D21 20PK	SCI TRANSMIT
8	-	-
9	D19 20VT/OR	BODY CONTROL MODULE FLASH ENABLE
10	-	-
11	-	-
12	-	-
13	-	-
14	D20 20LG	SCI RECEIVE
15	-	-
16	F33 20PK/RD	FUSED B(+)

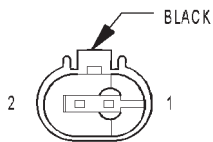

EGR  
SOLENOID  
(DIESEL)

EGR SOLENOID (DIESEL) - BLACK 2 WAY

CAV	CIRCUIT	FUNCTION
1	F15 18RD/LG	FUSED AUTO SHUT DOWN RELAY OUTPUT
2	K35 20GY/YL	EGR SOLENOID CONTROL

# CONNECTOR PINOUTS

## ENGINE CONTROL MODULE C1 (DIESEL) - BLACK 81 WAY

CAV	CIRCUIT	FUNCTION
1	Z108 14BK/DG	GROUND
2	Z108 14BK/DG	GROUND
3	K20 14DB	GENERATOR FIELD CONTROL
4	F142 14RD/DG	FUSED AUTO SHUT DOWN RELAY OUTPUT
5	F142 14RD/DG	FUSED AUTO SHUT DOWN RELAY OUTPUT
6	D52 18DG/WT	CAN C BUS(+)
7	D25 20VT/YL	PCI BUS
8	K944 20BR/DG	CAMSHAFT POSITION SENSOR GROUND
9	K44 20YL/GY	CAMSHAFT POSITION SENSOR SIGNAL
10	-	-
11	Y53 20BK/YL	BOOST PRESSURE SENSOR SIGNAL
12	K155 20YL/WT	MASS AIR FLOW SENSOR SIGNAL
13	Y40 20DG/VT	FUEL PRESSURE SENSOR SIGNAL
14	K22 20RD/DB	ACCELERATOR PEDAL POSITION SENSOR 2 SIGNAL
15	K81 20DB/DG	ACCELERATOR PEDAL POSITION SENSOR 1 SIGNAL
16	Y100 20BR/GY	FUEL PRESSURE SENSOR GROUND
17	-	-
18	-	-
19	F300 20RD/BK	BATTERY SENSE (+)
20	Z11 20BK/WT	BATTERY SENSE (-)
21	K4 18BK/LB	SENSOR GROUND
22	F991 20RD/DB	FUSED IGNITION SWITCH OUTPUT (RUN-START)
23	K6 18VT/WT	SENSOR REFERENCE VOLTAGE B
24	K3 20BK	CRANKSHAFT POSITION SENSOR SIGNAL 1
25	D51 18WT	CAN C BUS(-)
26	-	-
27	-	-
28	-	-
29	K77 20BR/WT	TRANSFER CASE POSITION SENSOR SIGNAL
30	G60 20BR/DB	ENGINE OIL PRESSURE SENSOR SIGNAL
31	-	-
32	K25 20VT/DG	BATTERY TEMPERATURE SENSOR SIGNAL
33	-	-
34	K255 20WT/DG	ACCELERATOR PEDAL POSITION SENSOR 1 GROUND
35	Y43 20WT/VT	ACCELERATOR PEDAL POSITION SENSOR 1 5-VOLT SUPPLY
36	C18 20DB	A/C PRESSURE SENSOR SIGNAL
37	-	-
38	V37 20RD/DG	SPEED CONTROL SWITCH SIGNAL
39	K226 20DB/WT	FUEL LEVEL SENSOR SIGNAL
40	K2 20DG/RD	ENGINE COOLANT TEMPERATURE SENSOR SIGNAL
41	K21 20DG/WT	INTAKE AIR TEMPERATURE SENSOR SIGNAL
42	Y101 20	CRANKSHAFT POSITION SENSOR SHIELD
43	K924 20YL	CRANKSHAFT POSITION SENSOR SIGNAL 2
44	-	-
45	-	-
46	-	-
47	L50 20WT/DB	PRIMARY BRAKE SWITCH SIGNAL
48	K29 20WT/PK	SECONDARY BRAKE SWITCH SIGNAL
49	-	-
50	F855 18BR/YL	SENSOR REFERENCE VOLTAGE A
51	-	-
52	-	-
53	-	-
54	Z189 20BR	MASS AIR FLOW SENSOR GROUND
55	B22 20DG/YL	VEHICLE SPEED SENSOR SIGNAL
56	K225 18BK	ACCELERATOR PEDAL POSITION SENSOR 2 GROUND
57	-	-
58	K4 20BK/LB	WATER IN FUEL SENSOR GROUND
59	K900 18GY	INTAKE PORT SWIRL ACTUATOR SIGNAL
60	K7 20RD/WT	FUEL PRESSURE SENSOR 5 VOLT SUPPLY
61	K51 20DB/YL	AUTO SHUT DOWN RELAY CONTROL
62	-	-
63	-	-
64	-	-
65	-	-
66	-	-
67	K173 20GY	HYDRAULIC RADIATOR FAN SOLENOID CONTROL
68	-	-
69	C13 20DB/RD	A/C COMPRESSOR CLUTCH RELAY CONTROL
70	-	-
71	-	-
72	K236 20GY/PK	GLOW PLUG RELAY NO. 2 CONTROL
73	-	-
74	T752 20DG/RD	ENGINE STARTER MOTOR RELAY CONTROL
75	K132 20BR/BK	VISCOUS/CABIN HEATER RELAY CONTROL
76	Y42 20BR/BK	WASTEGATE SOLENOID CONTROL
77	K152 20WT	GLOW PLUG RELAY NO. 1 CONTROL
78	-	-
79	-	-
80	K46 20DB/BK	FUEL PRESSURE SOLENOID CONTROL
81	K46 20DB/BK	FUEL PRESSURE SOLENOID CONTROL

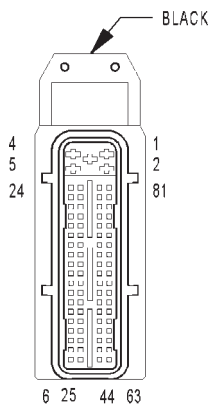

ENGINE CONTROL MODULE C1 (DIESEL)

CONNECTOR PINOUTS

## ENGINE CONTROL MODULE C2 (DIESEL) - BLACK 40 WAY

CAV	CIRCUIT	FUNCTION
82	D21 20PK	SCI TRANSMIT
83	-	-
84	-	-
85	-	-
86	-	-
87	-	-
88	-	-
89	K35 20GY/YL	EGR SOLENOID CONTROL
90	-	-
91	-	-
92	-	-
93	-	-
94	G123 20DG/WT	WATER IN FUEL SIGNAL
95	-	-
96	-	-
97	-	-
98	-	-
99	-	-
100	-	-
101	-	-
102	-	-
103	-	-
104	-	-
105	-	-
106	-	-
107	-	-
108	-	-
109	-	-
110	-	-
111	-	-
112	T41 20BK/WT	PARK/NEUTRAL POSITION SWITCH SENSE
113	-	-
114	-	-
115	K14 14BK/YL	FUEL INJECTOR NO. 4 CONTROL
116	K63 14BK	COMMON INJECTOR DRIVER
117	-	-
118	K11 14BK/DB	FUEL INJECTOR NO. 1 CONTROL
119	K38 14BK/DG	FUEL INJECTOR NO. 5 CONTROL
120	K12 14BK/VT	FUEL INJECTOR NO. 2 CONTROL
121	K13 14BK/RD	FUEL INJECTOR NO. 3 CONTROL

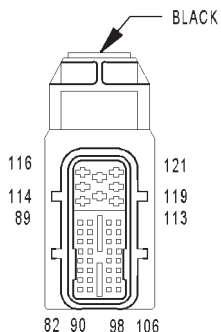

ENGINE CONTROL MODULE C2 (DIESEL)

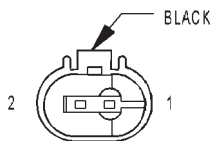

ENGINE COOLANT TEMPERATURE SENSOR (DIESEL)

## ENGINE COOLANT TEMPERATURE SENSOR (DIESEL) - BLACK 2 WAY

CAV	CIRCUIT	FUNCTION
1	K4 20BK/LB	SENSOR GROUND
2	K2 20DG/RD	ENGINE COOLANT TEMPERATURE SENSOR SIGNAL

# CONNECTOR PINOUTS

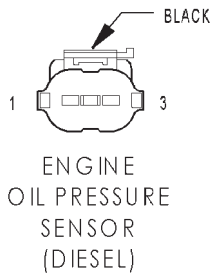

**ENGINE OIL PRESSURE SENSOR (DIESEL) - BLACK 3 WAY**

CAV	CIRCUIT	FUNCTION
1	K6 18VT/WT	SENSOR REFERENCE VOLTAGE B
2	G60 20BR/DB	ENGINE OIL PRESSURE SENSOR SIGNAL
3	K4 18BK/LB	SENSOR GROUND



**FUEL INJECTOR NO. 1 (DIESEL) - BLACK 2 WAY**

CAV	CIRCUIT	FUNCTION
1	K11 14BK/DB	FUEL INJECTOR NO. 1 CONTROL
2	K63 14BK	COMMON INJECTOR DRIVER

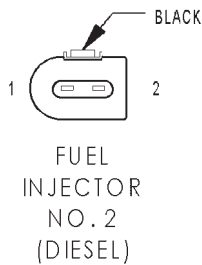

**FUEL INJECTOR NO. 2 (DIESEL) - BLACK 2 WAY**

CAV	CIRCUIT	FUNCTION
1	K12 14BK/VT	FUEL INJECTOR NO. 2 CONTROL
2	K63 14BK	COMMON INJECTOR DRIVER

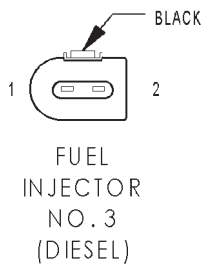

**FUEL INJECTOR NO. 3 (DIESEL) - BLACK 2 WAY**

CAV	CIRCUIT	FUNCTION
1	K13 14BK/RD	FUEL INJECTOR NO. 3 CONTROL
2	K63 14BK	COMMON INJECTOR DRIVER

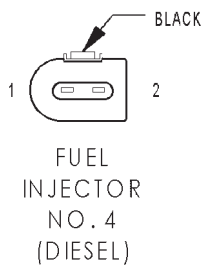

**FUEL INJECTOR NO. 4 (DIESEL) - BLACK 2 WAY**

CAV	CIRCUIT	FUNCTION
1	K14 14BK/YL	FUEL INJECTOR NO. 4 CONTROL
2	K63 14BK	COMMON INJECTOR DRIVER

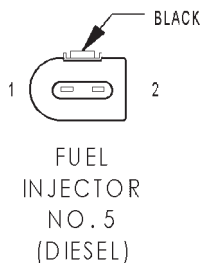

**FUEL INJECTOR NO. 5 (DIESEL) - BLACK 2 WAY**

CAV	CIRCUIT	FUNCTION
1	K38 14BK/DG	FUEL INJECTOR NO. 5 CONTROL
2	K63 14BK	COMMON INJECTOR DRIVER

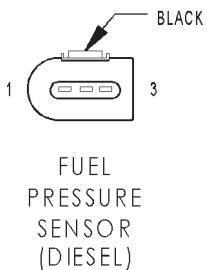

**FUEL PRESSURE SENSOR (DIESEL) - BLACK 3 WAY**

CAV	CIRCUIT	FUNCTION
1	Y100 20BR/GY	FUEL PRESSURE SENSOR GROUND
2	Y40 20DG/VT	FUEL PRESSURE SENSOR SIGNAL
3	K7 20RD/WT	FUEL PRESSURE SENSOR 5 VOLT SUPPLY

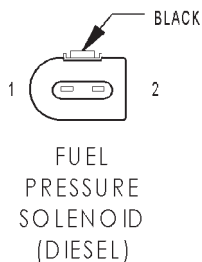

**FUEL PRESSURE SOLENOID (DIESEL) - BLACK 2 WAY**

CAV	CIRCUIT	FUNCTION
1	K46 20DB/BK	FUEL PRESSURE SOLENOID CONTROL
2	F142 16RD/DG	FUSED AUTO SHUT DOWN RELAY OUTPUT

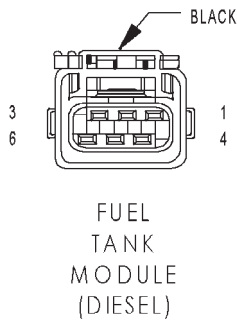

**FUEL TANK MODULE (DIESEL) - BLACK 6 WAY**

CAV	CIRCUIT	FUNCTION
1	-	-
2	-	-
3	K226 20LB/YL	FUEL LEVEL SENSOR SIGNAL
4	K4 20BK/LB	SENSOR GROUND
5	-	-
6	-	-



# CONNECTOR PINOUTS

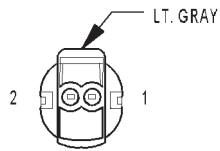

GENERATOR  
(DIESEL)

## GENERATOR (DIESEL) - LT. GRAY 2 WAY

CAV	CIRCUIT	FUNCTION
1	F15 14DB/WT	FUSED AUTO SHUT DOWN RELAY OUTPUT
2	K20 14DB	GENERATOR FIELD CONTROL

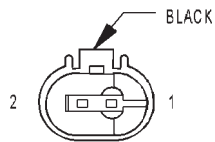

INTAKE  
AIR  
TEMPERATURE  
SENSOR  
(DIESEL)

## INTAKE AIR TEMPERATURE SENSOR (DIESEL) - BLACK 2 WAY

CAV	CIRCUIT	FUNCTION
1	K4 20BK/LB	SENSOR GROUND
2	K21 20DG/WT	INTAKE AIR TEMPERATURE SENSOR SIGNAL

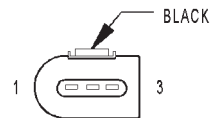

INTAKE PORT  
SWIRL  
ACTUATOR  
(DIESEL)

## INTAKE PORT SWIRL ACTUATOR (DIESEL) - BLACK 3 WAY

CAV	CIRCUIT	FUNCTION
1	Z18 18BK	GROUND
2	F15 18RD/DG	FUSED AUTO SHUT DOWN RELAY OUTPUT
3	K900 18GY	INTAKE PORT SWIRL ACTUATOR SIGNAL

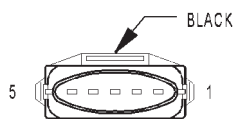

MASS  
AIR FLOW  
SENSOR  
(DIESEL)

## MASS AIR FLOW SENSOR (DIESEL) - BLACK 5 WAY

CAV	CIRCUIT	FUNCTION
1	-	-
2	F15 16RD/DG	FUSED AUTO SHUT DOWN RELAY OUTPUT
3	Z189 20BR	GROUND
4	F855 20BR/YL	SENSOR REFERENCE VOLTAGE A
5	K155 20YL/WT	MASS AIR FLOW SENSOR SIGNAL

POWER DISTRIBUTION CENTER (DIESEL)

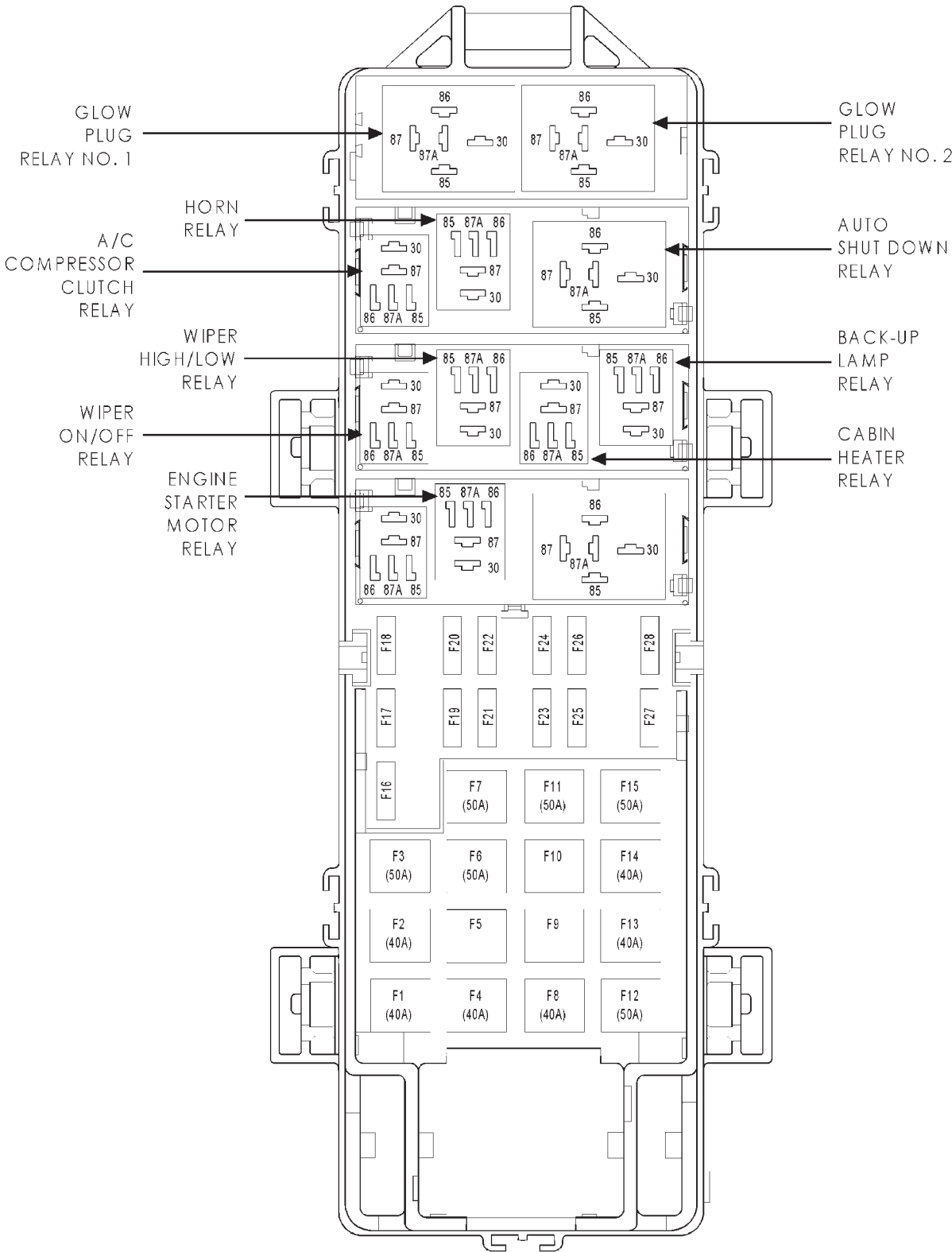

CONNECTOR PINOUTS

# CONNECTOR PINOUTS

## FUSES (DIESEL)

FUSE NO.	AMPS	FUSED CIRCUIT	FUNCTION
1	40A	C1 12DG	FUSED B(+)
2	40A	A149 12RD/TN	FUSED B(+)
3	50A	A145 10WT/RD	FUSED B(+)
4	40A	A10 12RD/DG	FUSED B(+)
5	-	-	-
6	50A	A105 10DB/RD	FUSED B(+)
7	50A	A147 10RD/GY	FUSED B(+)
8	40A	A1 12RD	FUSED B(+)
9	-	-	-
10	-	-	-
11	50A	A110 10VT/RD	FUSED B(+)
12	50A	A146 10OR/WT	FUSED B(+)
13	40A	A14 14RD/WT	FUSED B(+)
14	40A	A2 12PK/BK	FUSED B(+)
15	50A	A148 10PK/WT	FUSED B(+)
16	20A	F15 18DB/WT	FUSED AUTO SHUT DOWN RELAY OUTPUT
16	20A	F15 18 DB/WT	FUSED AUTO SHUT DOWN RELAY OUTPUT
17	-	-	-
18	15A	F62 18RD	FUSED B(+)
18	15A	F62 18RD	FUSED B(+)
19	-	-	-
20	-	-	-
21	15A	A17 14RD/BK	FUSED B(+)
22	10A	F300 18RD/BK	FUSED B(+)
23	15A	A80 18RD/LG	FUSED B(+)
24	-	-	-
25	20A	A20 12RD/DB	FUSED B(+)
26	20A	F142 14OR/DG	FUSED AUTO SHUT DOWN RELAY OUTPUT
27	20A	A148 16LG/RD	FUSED B(+)
28	-	-	-

## A/C COMPRESSOR CLUTCH RELAY (DIESEL)

CAV	CIRCUIT	FUNCTION
30	A17 14RD/BK	FUSED B(+)
85	C13 18DB/OR	A/C COMPRESSOR CLUTCH RELAY CONTROL
86	F15 18DB/WT	FUSED AUTO SHUT DOWN RELAY OUTPUT
86	F15 18DB/WT	FUSED AUTO SHUT DOWN RELAY OUTPUT
87	C2 18DB/BK	A/C COMPRESSOR CLUTCH RELAY OUTPUT
87A	-	-

## AUTO SHUT DOWN RELAY (DIESEL)

CAV	CIRCUIT	FUNCTION
30	A14 14RD/WT	FUSED B(+)
85	K51 18DB/YL	AUTOMATIC SHUT DOWN RELAY CONTROL
86	A14 14RD/WT	FUSED B(+)
87	A142 14DG/OR	AUTOMATIC SHUT DOWN RELAY OUTPUT
87	A142 14DG/OR	AUTOMATIC SHUT DOWN RELAY OUTPUT
87A	-	-

# CONNECTOR PINOUTS

## ENGINE STARTER MOTOR RELAY (DIESEL)

CAV	CIRCUIT	FUNCTION
30	A1 12RD	FUSED B(+)
85	T752 18DG/OR	ENGINE STARTER MOTOR RELAY CONTROL
86	F45 18YL/RD	FUSED IGNITION SWITCH OUTPUT (START)
87	T40 12BR	ENGINE STARTER MOTOR RELAY OUTPUT
87A	-	-

## GLOW PLUG RELAY NO. 1 (DIESEL)

CAV	CIRCUIT	FUNCTION
30	A105 10DB/RD	FUSED B(+)
85	K152 18WT	GLOW PLUG RELAY NO. 1 CONTROL
86	F15 20DB/WT	FUSED AUTO SHUT DOWN RELAY OUTPUT
86	F15 20DB/WT	FUSED AUTO SHUT DOWN RELAY OUTPUT
87	K154 10GY	GLOW PLUG RELAY NO. 1 OUTPUT
87A	-	-

## GLOW PLUG RELAY NO. 2 (DIESEL)

CAV	CIRCUIT	FUNCTION
30	A110 VT/RD	FUSED B(+)
85	K236 18GY/PK	GLOW PLUG RELAY NO. 2 CONTROL
86	F15 20DB/WT	FUSED AUTO SHUT DOWN RELAY OUTPUT
86	F15 20DB/WT	FUSED AUTO SHUT DOWN RELAY OUTPUT
87	K254 10GY/YL	GLOW PLUG RELAY NO. 2 OUTPUT
87A	-	-

## VISCOUS/CABIN HEATER RELAY (DIESEL)

CAV	CIRCUIT	FUNCTION
30	A80 18RD/LG	FUSED B(+)
85	K132 18BR/BK	VISCOUS/CABIN HEATER RELAY CONTROL
86	F15 18DB/WT	FUSED AUTO SHUT DOWN RELAY OUTPUT
86	F15 18DB/WT	FUSED AUTO SHUT DOWN RELAY OUTPUT
87	A82 18PK/LG	VISCOUS/CABIN HEATER RELAY OUTPUT
87A	-	-

# CONNECTOR PINOUTS

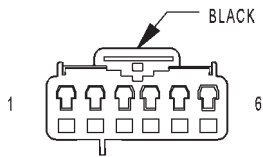

SENTRY KEY  
IMMOBILIZER  
MODULE

SENTRY KEY IMMOBILIZER MODULE - BLACK 6 WAY		
CAV	CIRCUIT	FUNCTION
1	M1 20PK	FUSED B(+)
2	Z132 20BK/OR	GROUND
3	G5 20DB/WT	FUSED IGNITION SWITCH OUTPUT (RUN-START)
4	-	-
5	D25 20YL/VT/BK	PCI BUS
6	-	-

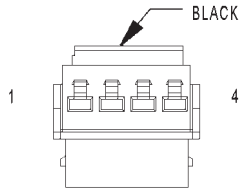

SPEED  
CONTROL  
SWITCH  
NO. 1

SPEED CONTROL SWITCH NO. 1 - BLACK 4 WAY		
CAV	CIRCUIT	FUNCTION
1	-	-
2	K4 20BK/LB	SENSOR GROUND
3	V37 20RD/LG	SPEED CONTROL SWITCH SIGNAL
4	-	-

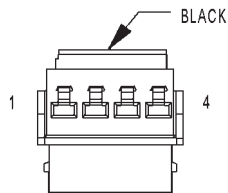

SPEED  
CONTROL  
SWITCH  
NO. 2

SPEED CONTROL SWITCH NO. 2 - BLACK 4 WAY		
CAV	CIRCUIT	FUNCTION
1	-	-
2	K4 20BK/LB	SENSOR GROUND
3	V37 20RD/LG	SPEED CONTROL SWITCH SIGNAL
4	-	-

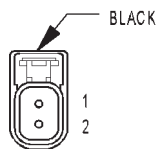

TRANSFER CASE  
POSITION  
SENSOR

TRANSFER CASE POSITION SENSOR - BLACK 2 WAY		
CAV	CIRCUIT	FUNCTION
1	K77 20BR/WT (DIESEL)	TRANSFER CASE POSITION SENSOR SIGNAL
1	K77 18LG/BK (GAS)	TRANSFER CASE POSITION SENSOR SIGNAL
2	K4 20BK/LB (DIESEL)	SENSOR GROUND
2	K4 18BK/LB (GAS)	SENSOR GROUND

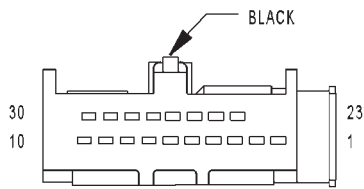

TRANSMISSION  
CONTROL  
MODULE C1  
(DIESEL)

TRANSMISSION CONTROL MODULE C1 (DIESEL) - BLACK 18 WAY		
CAV	CIRCUIT	FUNCTION
1	D21 20PK	SCI TRANSMIT
2	-	-
3	W4 20PK/OR	SHIFTER C5 SENSE
4	Y1 20DB/PK	PARK LOCKOUT SOLENOID CONTROL
5	-	-
6	-	-
7	T41 20BK/WT	PARK/NEUTRAL POSITION SWITCH SENSE
8	-	-
9	-	-
10	-	-
23	-	-
24	-	-
25	W0 20DB/WT	SHIFTER C1 SENSE
26	W1 20VT/WT	SHIFTER C2 SENSE
27	W2 20VT	SHIFTER C3 SENSE
28	W3 20BK	SHIFTER C4 SENSE
29	F991 20OR/DB	FUSED IGNITION SWITCH OUTPUT (RUN-START)
30	Z234 20WT	GROUND

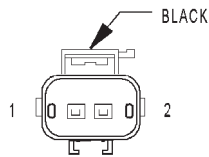

VISCOUS/CABIN  
HEATER  
(DIESEL)

VISCOUS/CABIN HEATER (DIESEL) - BLACK 2 WAY		
CAV	CIRCUIT	FUNCTION
1	A82 16PK/LG	VISCOUS/CABIN HEATER RELAY OUTPUT
2	Z18 16BK	GROUND



WASTEGATE  
SOLENOID  
(DIESEL)

WASTEGATE SOLENOID (DIESEL) - 2 WAY		
CAV	CIRCUIT	FUNCTION
1	F15 18DB/WT	FUSED AUTO SHUT DOWN RELAY OUTPUT
2	Y42 18OR/DB	WASTEGATE SOLENOID CONTROL

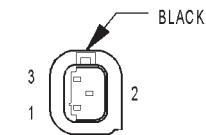

WATER IN  
FUEL SENSOR  
(DIESEL)

WATER IN FUEL SENSOR (DIESEL) - BLACK 3 WAY		
CAV	CIRCUIT	FUNCTION
1	K4 20BK/LB	SENSOR GROUND
2	G123 20DG/WT	WATER IN FUEL SENSOR SIGNAL
3	F15 20RD/DG	FUSED AUTO SHUT DOWN RELAY OUTPUT



10.0 SCHEMATIC DIAGRAMS

10.1 ENGINE CONTROL MODULE

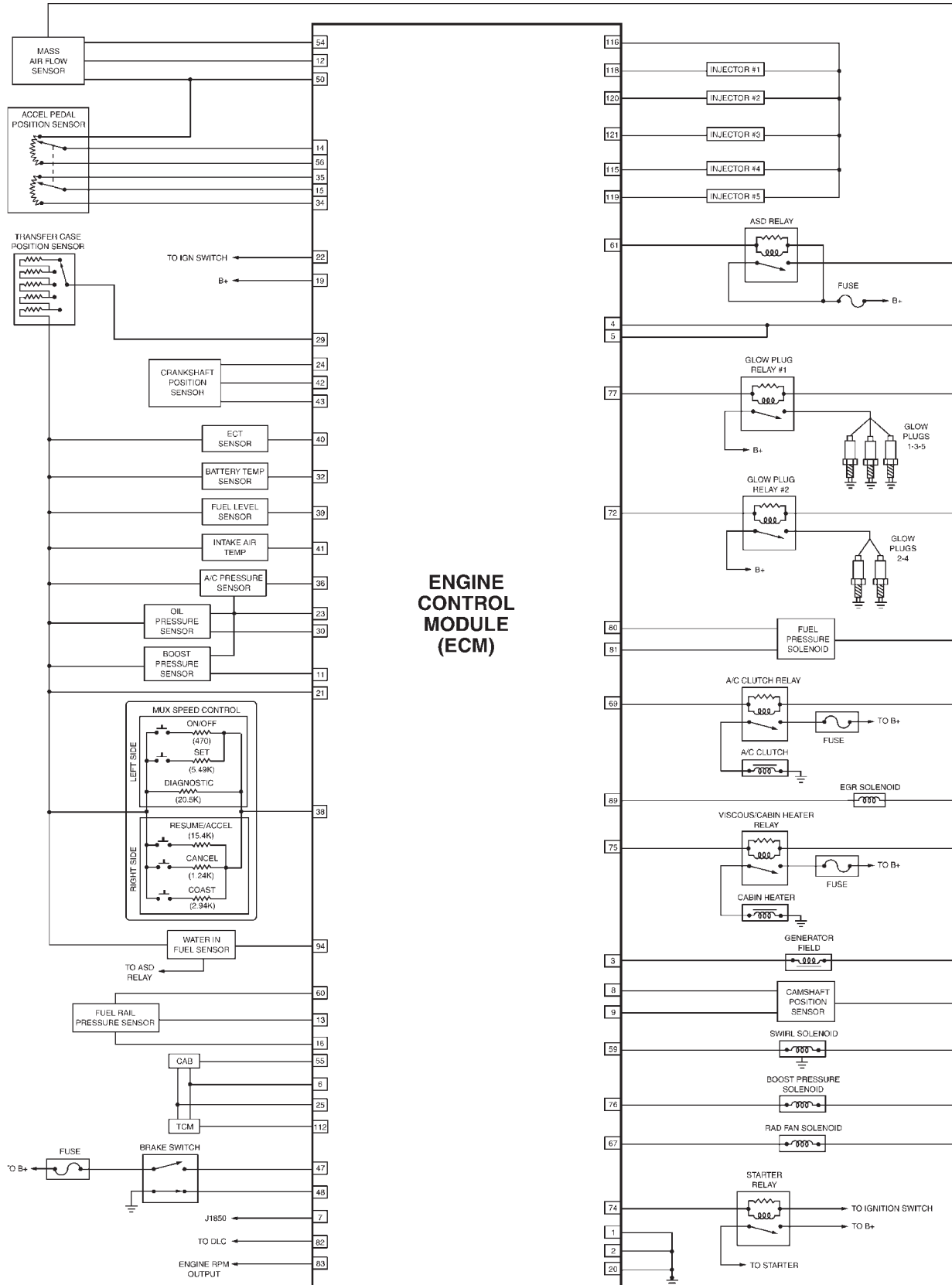

SCHEMATIC DIAGRAMS





11.0 CHARTS AND GRAPHS

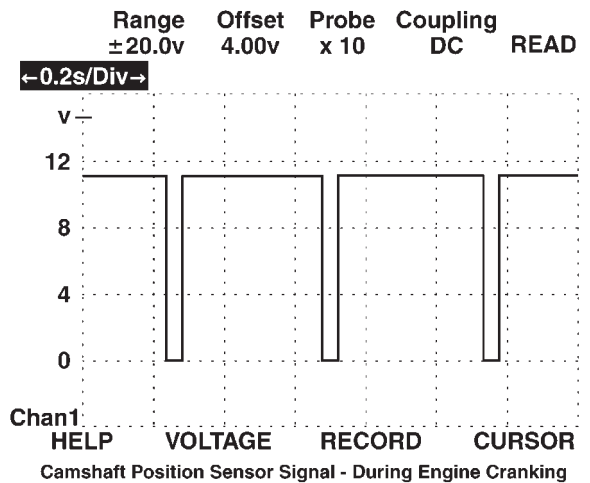

80c7708b

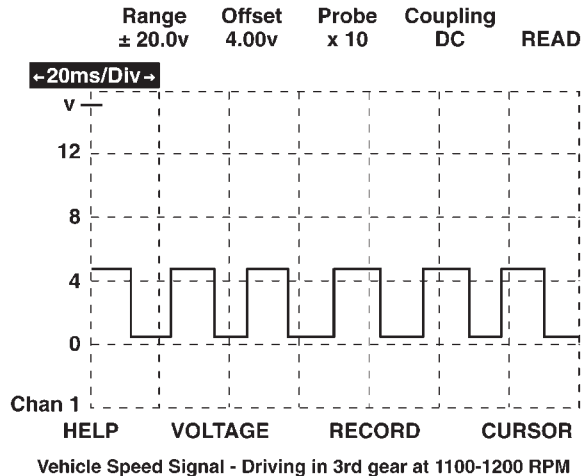

80bc7ab4

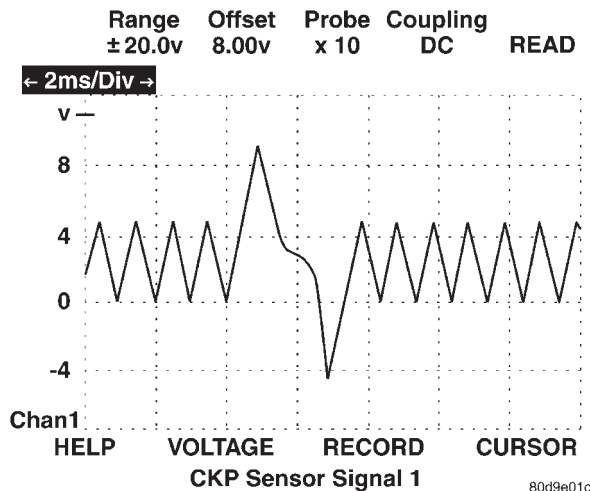

80d9e01c

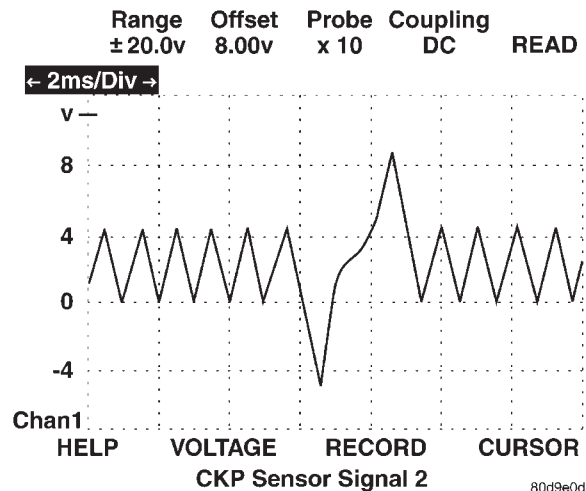

80d9e0d8

